

LM4755 Stereo 11W Audio Power Amplifier with Mute

Check for Samples: [LM4755](#)

FEATURES

- Drives 4Ω and 8Ω Loads
- Integrated Mute Function
- Internal Gain Resistors
- Minimal External Components Needed
- Single Supply Operation
- Internal Current Limiting and Thermal Protection
- Compact 9-lead TO-220 Package
- Wide Supply Range 9V - 40V

APPLICATIONS

- Stereos TVs
- Compact Stereos
- Mini Component Stereos

KEY SPECIFICATIONS

- Output Power at 10% THD with 1kHz into 4Ω at $V_{CC} = 24V$ 11 W (typ)
- Output Power at 10% THD with 1kHz into 8Ω at $V_{CC} = 24V$ 7 W (typ)
- Closed Loop Gain 34 dB (typ)
- P_O at 10% THD+N @ 1kHz into 4Ω Single-Ended DDPAK Package at $V_{CC}=12V$ 2.5 W (typ)
- P_O at 10% THD+N @ 1kHz into 8Ω Bridged DDPAK Package at $V_{CC}=12V$ 5 W (typ)

DESCRIPTION

The LM4755 is a stereo audio amplifier capable of delivering 11W per channel of continuous average output power to a 4Ω load or 7W per channel into 8Ω using a single 24V supply at 10% THD+N. The internal mute circuit and pre-set gain resistors provide for a very economical design solution.

Output power specifications at both 20V and 24V supplies and low external component count offer high value to consumer electronic manufacturers for stereo TV and compact stereo applications. The LM4755 is specifically designed for single supply operation.



Please be aware that an important notice concerning availability, standard warranty, and use in critical applications of Texas Instruments semiconductor products and disclaimers thereto appears at the end of this data sheet.

All trademarks are the property of their respective owners.

TYPICAL APPLICATION

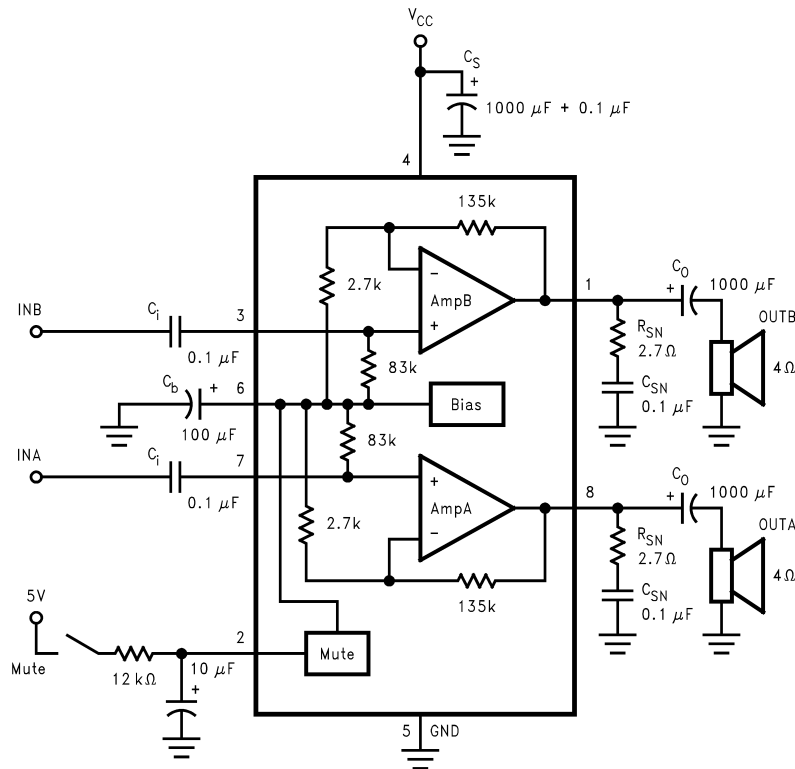
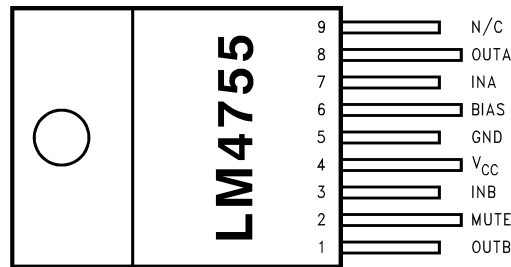
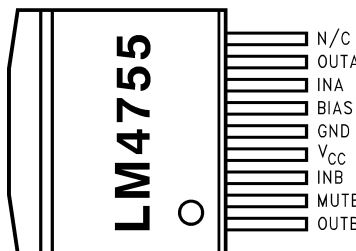

Figure 1. Typical Audio Amplifier Application Circuit

Connection Diagram



9 Pin TO-220
Plastic Package (Top View)
See Package Number NEC



9 Pin DPAK
Plastic Package (Top View)
See Package Number KTW



These devices have limited built-in ESD protection. The leads should be shorted together or the device placed in conductive foam during storage or handling to prevent electrostatic damage to the MOS gates.

ABSOLUTE MAXIMUM RATINGS⁽¹⁾⁽²⁾⁽³⁾⁽⁴⁾

| | | |
|---|--------------------------|--------------------|
| Supply Voltage | | 40V |
| Input Voltage | | ±0.7V |
| Input Voltage at Output Pins ⁽⁵⁾ | | GND -0.4V |
| Output Current | | Internally Limited |
| Power Dissipation ⁽⁶⁾ | | 62.5W |
| ESD Susceptibility ⁽⁷⁾ | | 2 kV |
| Junction Temperature | | 150°C |
| Soldering Information | NEC Package (10 seconds) | 250°C |
| Storage Temperature | | -40°C to 150°C |

- (1) Absolute Maximum Ratings indicate limits beyond which damage to the device may occur. Operating Ratings indicate conditions for which the device is functional, but do not ensure specific performance limits. Electrical Characteristics state DC and AC electrical specifications under particular test conditions which ensure specific performance limits. This assumes that the device is within the Operating Ratings. Specifications are not ensured for parameters where no limit is given, however, the typical value is a good indication of device performance.
- (2) If Military/Aerospace specified devices are required, please contact the Texas Instruments Sales Office/Distributors for availability and specifications.
- (3) The TO-263 Package is not recommended for $V_S > 16V$ due to impractical heatsinking limitations.
- (4) All voltages are measured with respect to the GND pin (5), unless otherwise specified.
- (5) The outputs of the LM4755 cannot be driven externally in any mode with a voltage lower than -0.4V below GND or permanent damage to the LM4755 will result.
- (6) For operating at case temperatures above 25°C, the device must be derated based on a 150°C maximum junction temperature and a thermal resistance of $\theta_{JC} = 2^\circ\text{C/W}$ (junction to case). Refer to the section [DETERMINING MAXIMUM POWER DISSIPATION](#) in the [APPLICATION INFORMATION](#) section for more information.
- (7) Human body model, 100 pF discharged through a 1.5 kΩ resistor.

OPERATING RATINGS

| | |
|---|-----------------------|
| Temperature Range $T_{MIN} \leq T_A \leq T_{MAX}$ | -40°C ≤ T_A ≤ +85°C |
| Supply Voltage | 9V to 32V |
| θ_{JC} | 2°C/W |
| θ_{JA} | 76°C/W |

ELECTRICAL CHARACTERISTICS

The following specifications apply to each channel with $V_{CC} = 24V$, $T_A = 25^\circ\text{C}$ unless otherwise specified.

| Symbol | Parameter | Conditions | LM4755 | | Units (Limits) |
|-------------|---|--|------------------------|-------|----------------|
| | | | Typical ⁽¹⁾ | Limit | |
| I_{TOTAL} | Total Quiescent Power Supply Current | Mute Off | 10 | 15 | mA(max) |
| | | Mute On | 7 | 7 | mA(min) |
| P_O | Output Power (Continuous Average per Channel) | $f = 1 \text{ kHz}$, THD+N = 10%, $R_L = 8\Omega$ | 7 | 10 | W |
| | | $f = 1 \text{ kHz}$, THD+N = 10%, $R_L = 4\Omega$ | 11 | | W(min) |
| | | $V_S = 20V$, $R_L = 8\Omega$ | 4 | W | |
| | | $V_S = 20V$, $R_L = 4\Omega$ | 7 | W | |
| | | $f = 1 \text{ kHz}$, THD+N = 10%, $R_L = 4\Omega$ $V_S = 12V$, DDPK Pkg. | 2.5 | W | |
| THD | Total Harmonic Distortion | $f = 1 \text{ kHz}$, $P_O = 1 \text{ W/ch}$, $R_L = 8\Omega$ | 0.08 | | % |
| V_{OSW} | Output Swing | $P_O = 10W$, $R_L = 8\Omega$ | 15 | | V |
| | | $P_O = 10W$, $R_L = 4\Omega$ | 14 | | V |
| X_{TALK} | Channel Separation | See Apps. Circuit (Figure 1) $f = 1 \text{ kHz}$, $V_O = 4 \text{ Vrms}$ | 55 | | dB |

- (1) Typicals are measured at 25°C and represent the parametric norm.

ELECTRICAL CHARACTERISTICS (continued)

The following specifications apply to each channel with $V_{CC} = 24V$, $T_A = 25^\circ C$ unless otherwise specified.

| Symbol | Parameter | Conditions | LM4755 | | Units (Limits) |
|----------------------|---------------------------------------|--|------------------------|----------|--------------------|
| | | | Typical ⁽¹⁾ | Limit | |
| PSRR | Power Supply Rejection Ratio | See Apps. Circuit (Figure 1) $f = 120 \text{ Hz}$, $V_O = 1 \text{ mVrms}$ | 50 | | dB |
| V_{ODV} | Differential DC Output Offset Voltage | $V_{IN} = 0V$ | 0.09 | 0.4 | V(max) |
| SR | Slew Rate | | 2 | | V/ μs |
| R_{IN} | Input Impedance | | 83 | | k Ω |
| PBW | Power Bandwidth | 3 dB BW at $P_O = 2.5W$, $R_L = 8\Omega$ | 65 | | kHz |
| A_{VCL} | Closed Loop Gain (Internally Set) | $R_L = 8\Omega$ | 34 | 33 35 | dB(min) dB(max) |
| ϵ_{IN} | Noise | IHF-A Weighting Filter, $R_L = 8\Omega$ Output Referred | 0.2 | | mVrms |
| I_O | Output Short Circuit Limit | $V_{IN} = 0.5V$, $R_L = 2\Omega$ | | 2 | A(min) |
| Mute Pin V_{IL} | Mute Low Input Voltage | Not in Mute Mode | | 0.8 | V(max) |
| V_{IH} | Mute High Input Voltage | In Mute Mode | 2.0 | 2.5 | V(min) |
| A_M | Mute Attenuation | $V_{MUTE} = 5.0V$ | 80 | | dB |

EQUIVALENT SCHEMATIC

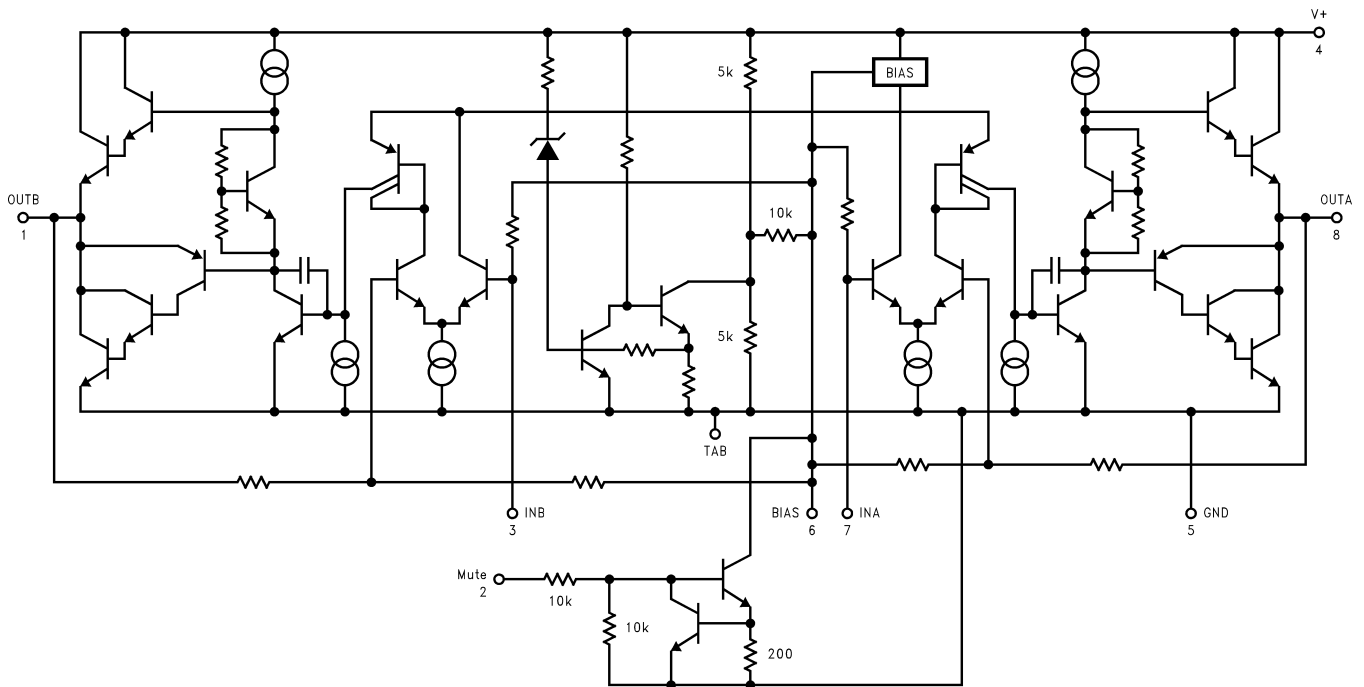

Figure 2.

TEST CIRCUIT

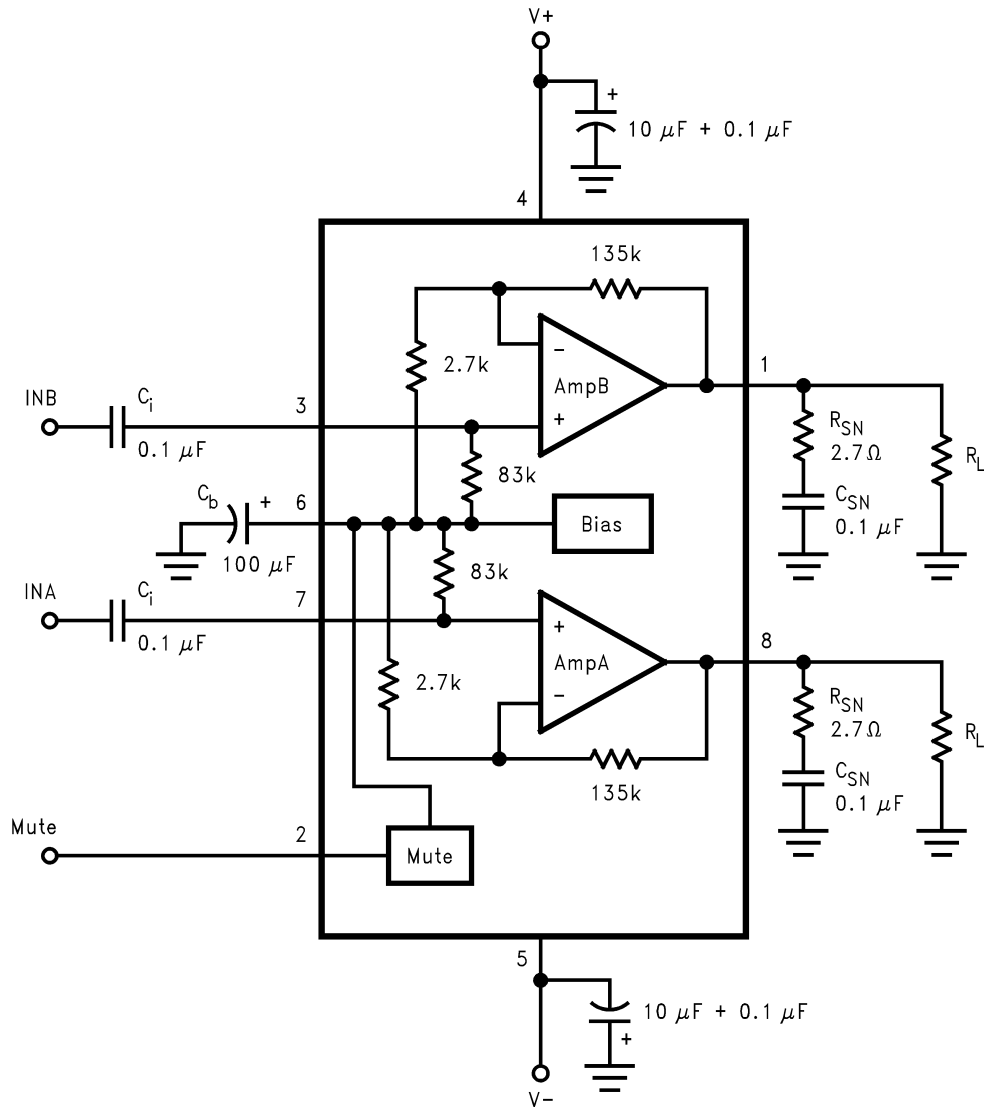

Figure 3. Test Circuit

SYSTEM APPLICATION CIRCUIT

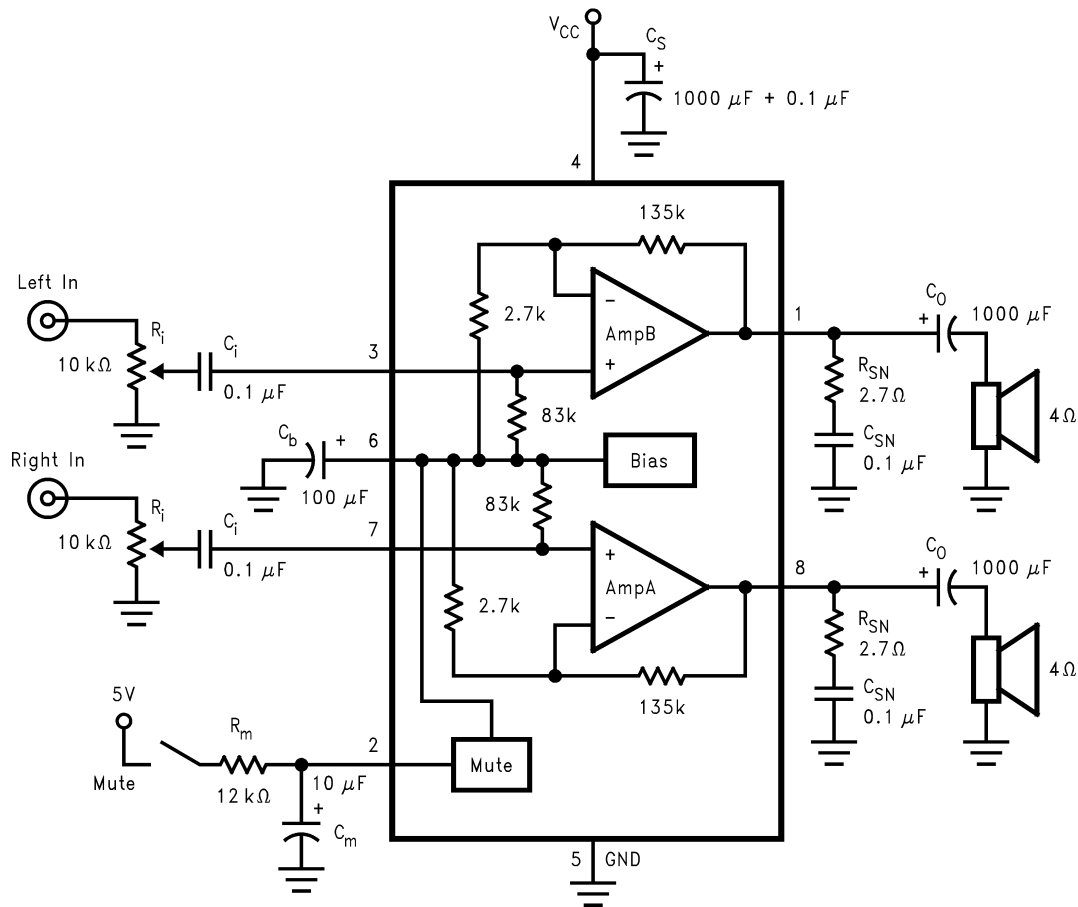

Figure 4. Circuit for External Components Description

EXTERNAL COMPONENTS DESCRIPTION

| Components | | Function Description |
|------------|----------|--|
| 1, 2 | C_S | Provides power supply filtering and bypassing. |
| 3, 4 | R_{SN} | Works with C_{SN} to stabilize the output stage from high frequency oscillations. |
| 5, 6 | C_{SN} | Works with R_{SN} to stabilize the output stage from high frequency oscillations. |
| 7 | C_b | Provides filtering for the internally generated half-supply bias generator. |
| 8, 9 | C_i | Input AC coupling capacitor which blocks DC voltage at the amplifier's input terminals. Also creates a high pass filter with $f_c=1/(2 \cdot \pi \cdot R_{in} \cdot C_{in})$. |
| 10, 11 | C_o | Output AC coupling capacitor which blocks DC voltage at the amplifier's output terminal. Creates a high pass filter with $f_c=1/(2 \cdot \pi \cdot R_{out} \cdot C_{out})$. |
| 12, 13 | R_i | Voltage control - limits the voltage level allowed to the amplifier's input terminals. |
| 14 | R_m | Works with C_m to provide mute function timing. |
| 15 | C_m | Works with R_m to provide mute function timing. |

TYPICAL PERFORMANCE CHARACTERISTICS

Typicals are measured at 25°C and represent the parametric norm.

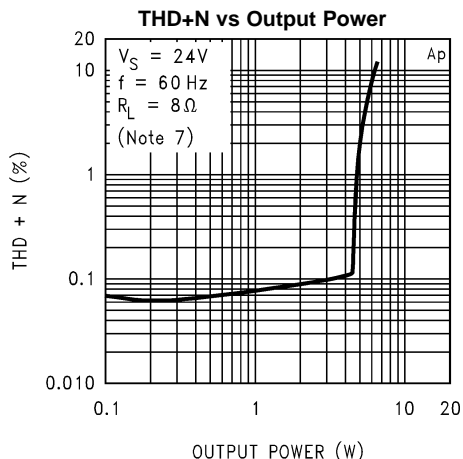

Figure 5.

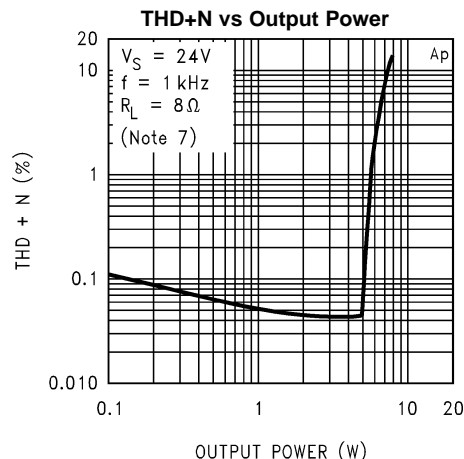

Figure 6.

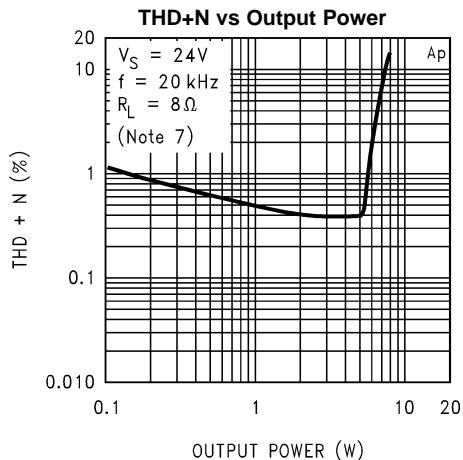

Figure 7.

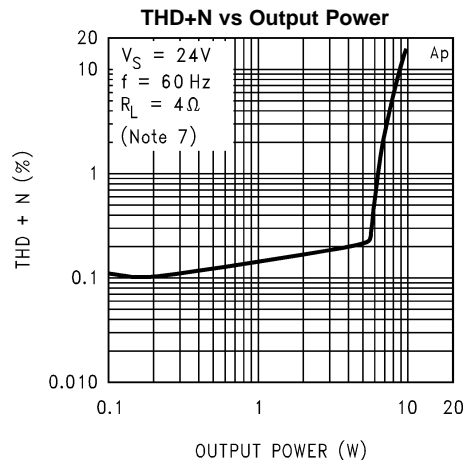

Figure 8.

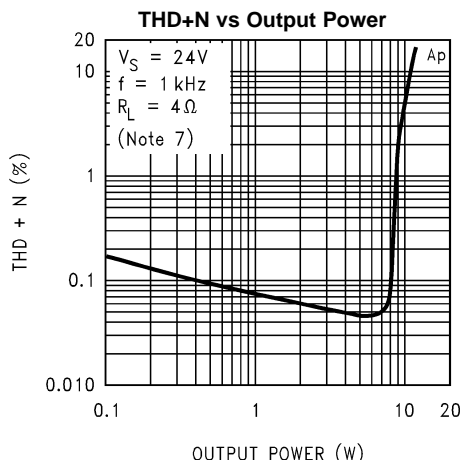

Figure 9.

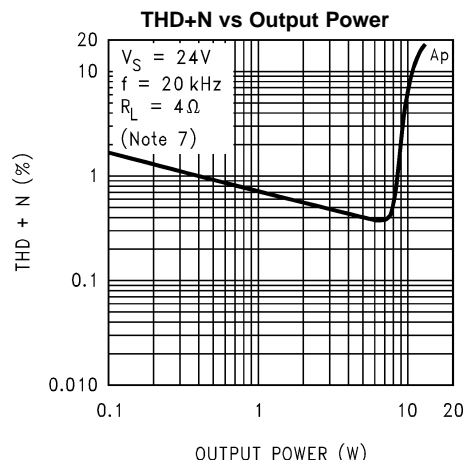

Figure 10.

TYPICAL PERFORMANCE CHARACTERISTICS (continued)

Typicals are measured at 25°C and represent the parametric norm.

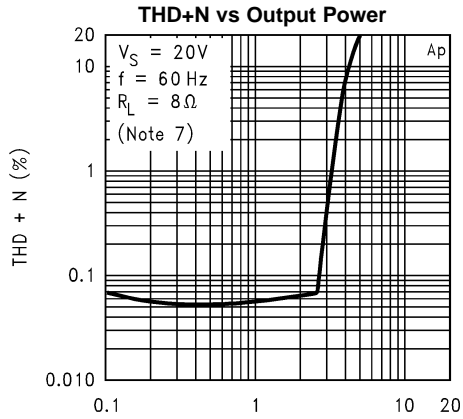

Figure 11.

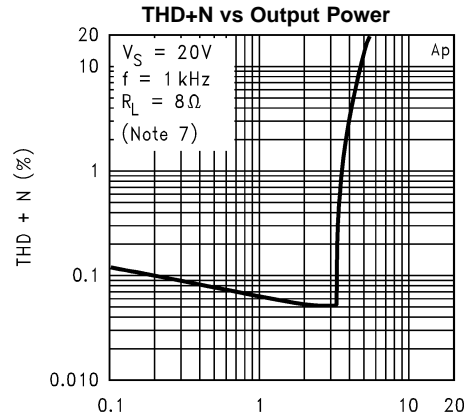

Figure 12.

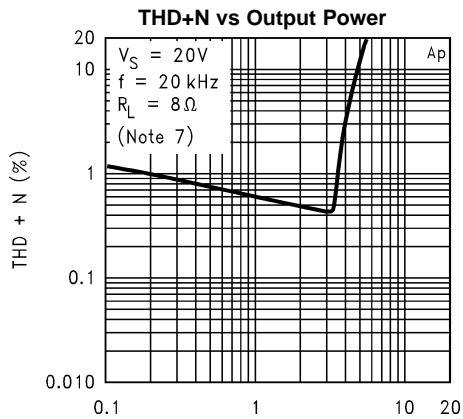

Figure 13.

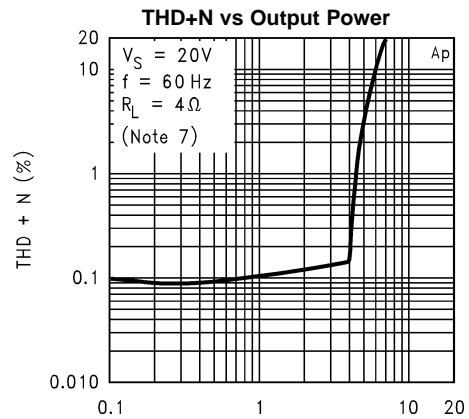

Figure 14.

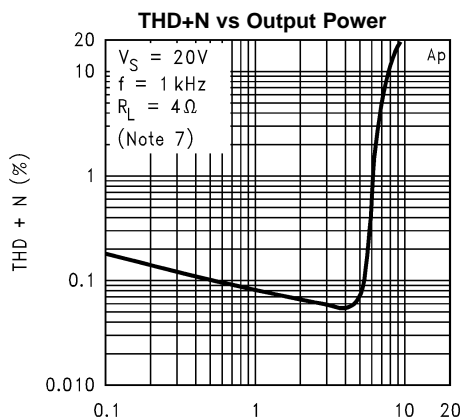

Figure 15.

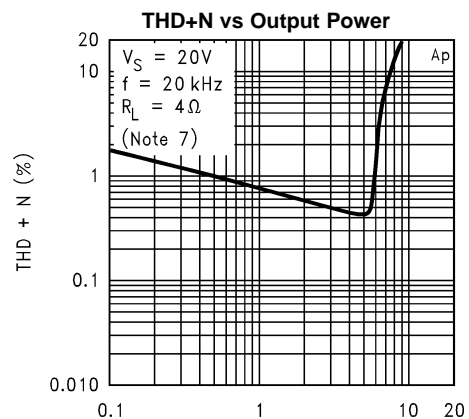

Figure 16.

TYPICAL PERFORMANCE CHARACTERISTICS (continued)

Typicals are measured at 25°C and represent the parametric norm.

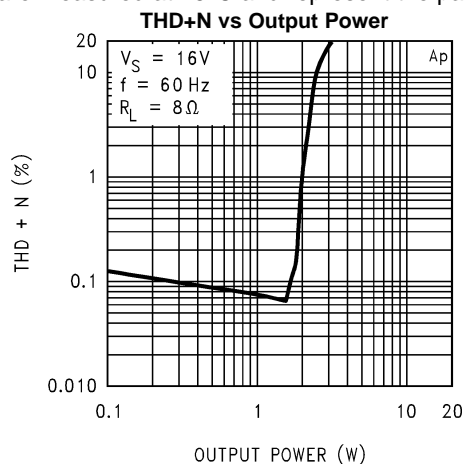

Figure 17.

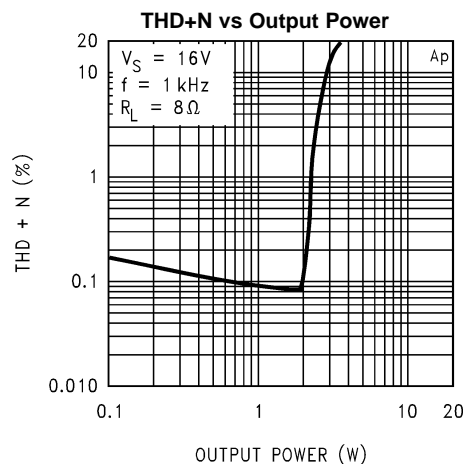

Figure 18.

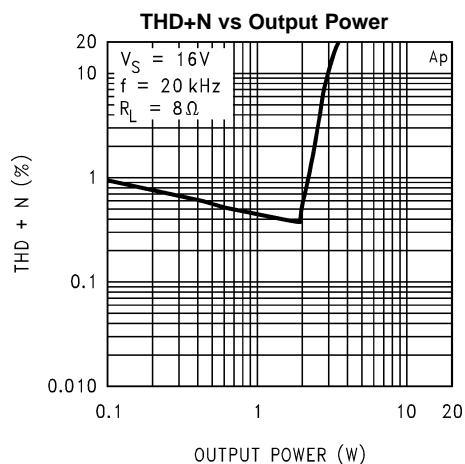

Figure 19.

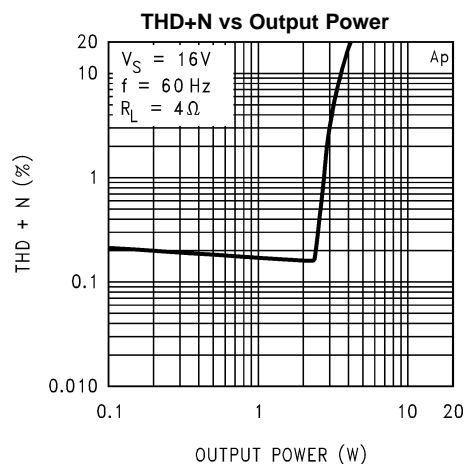

Figure 20.

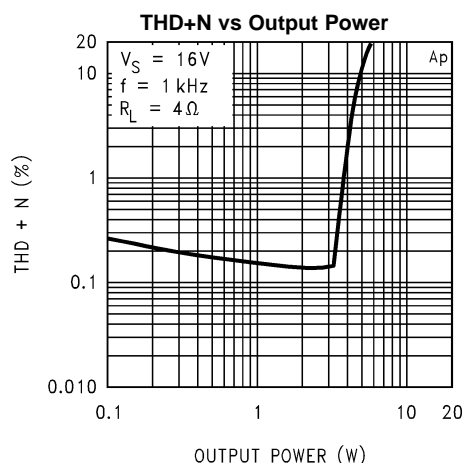

Figure 21.

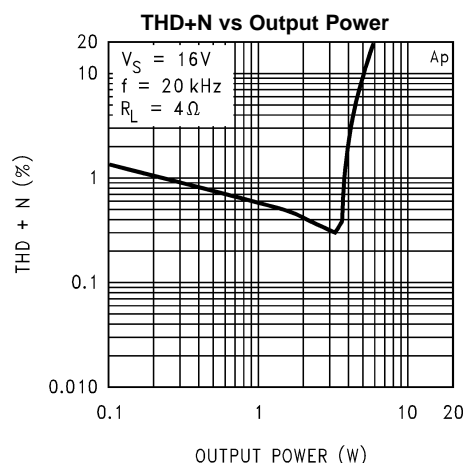
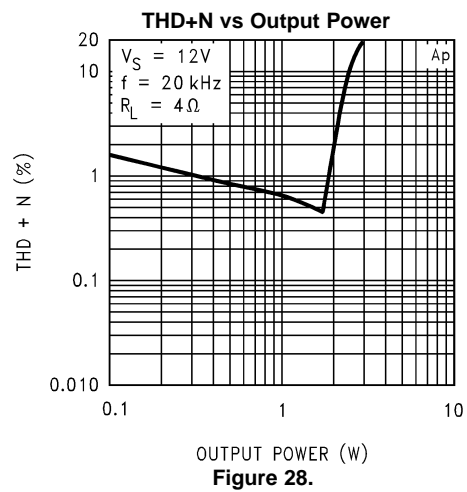
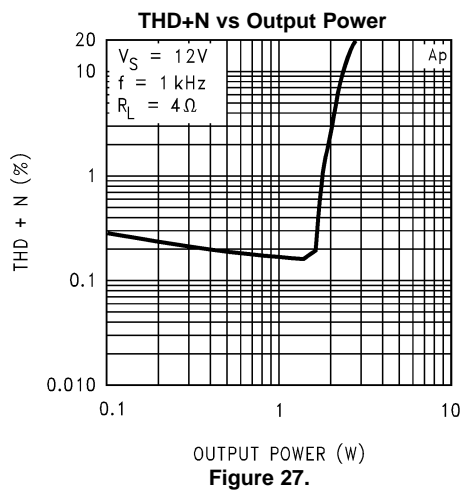
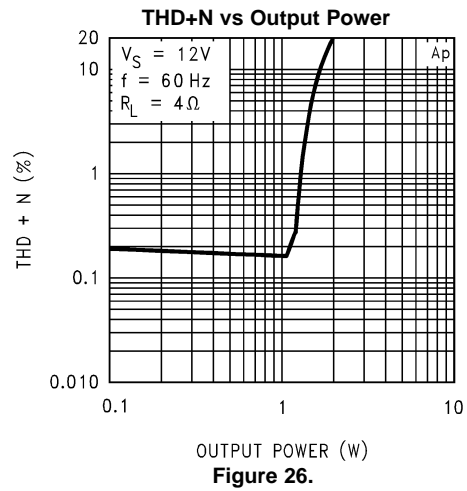
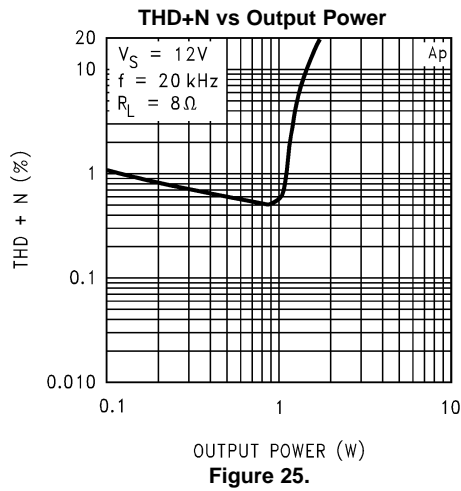
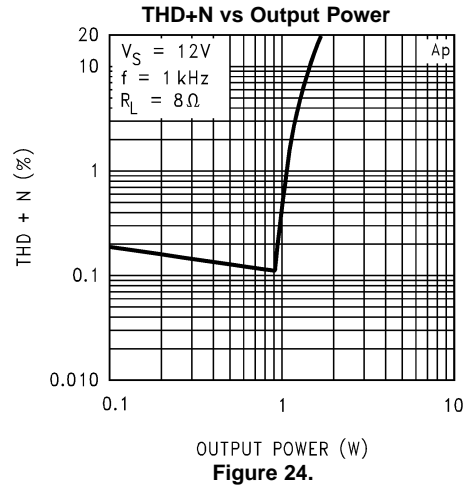
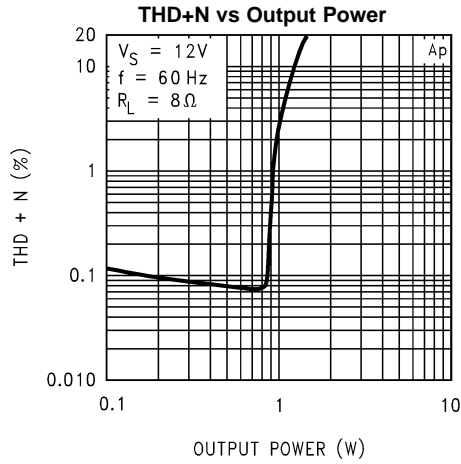

Figure 22.

TYPICAL PERFORMANCE CHARACTERISTICS (continued)

Typicals are measured at 25°C and represent the parametric norm.



TYPICAL PERFORMANCE CHARACTERISTICS (continued)

Typicals are measured at 25°C and represent the parametric norm.

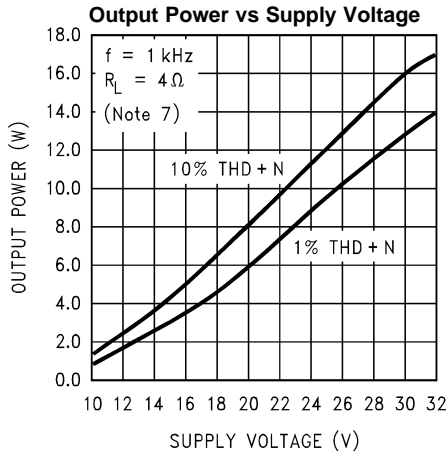

Figure 29.

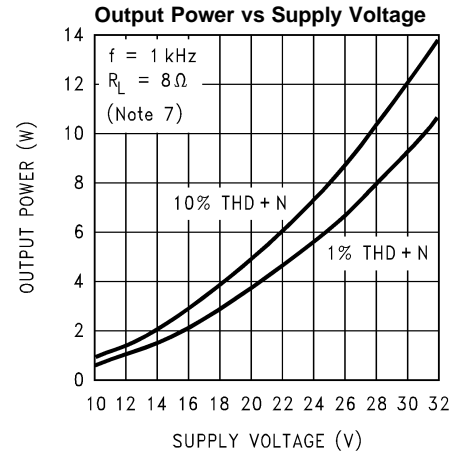

Figure 30.

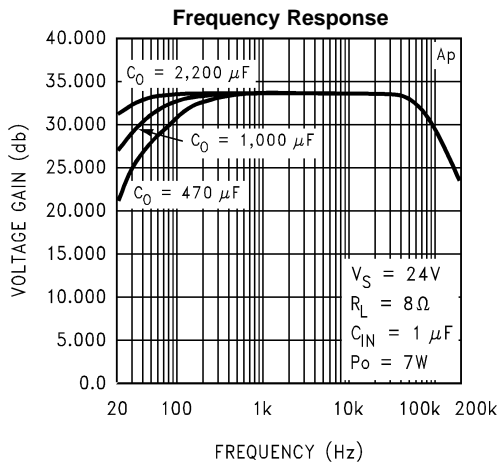

Figure 31.

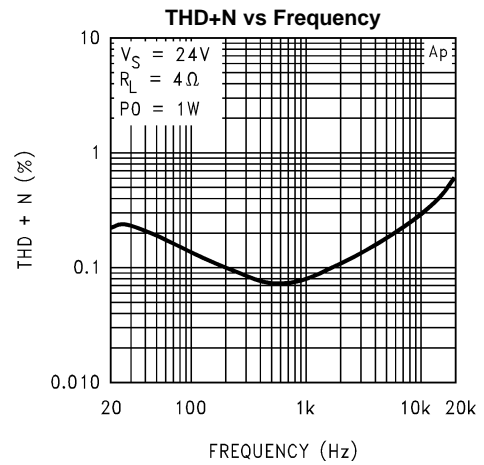

Figure 32.

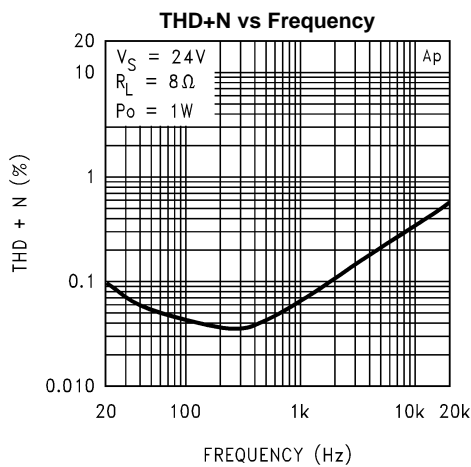

Figure 33.

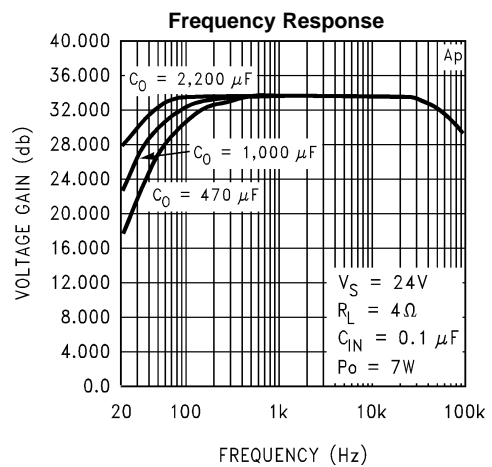

Figure 34.

TYPICAL PERFORMANCE CHARACTERISTICS (continued)

Typicals are measured at 25°C and represent the parametric norm.

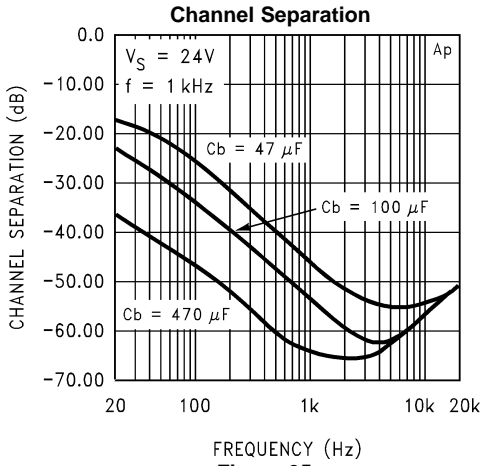

Figure 35.

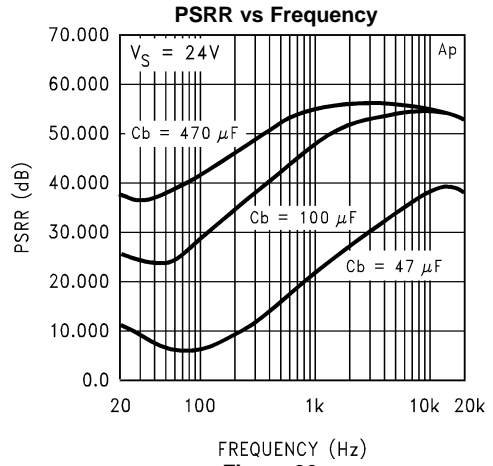

Figure 36.

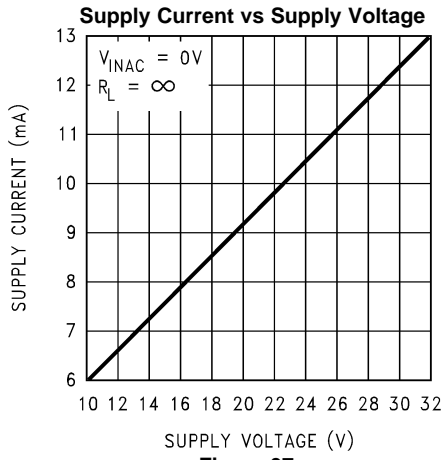

Figure 37.

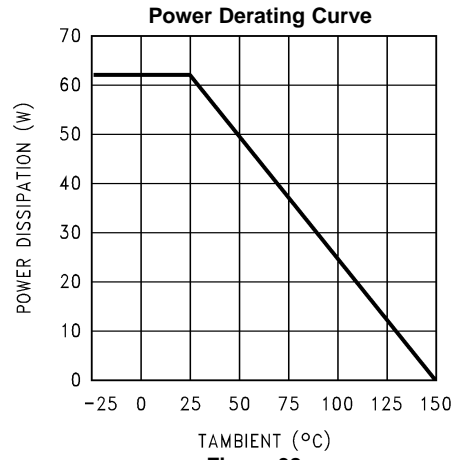

Figure 38.

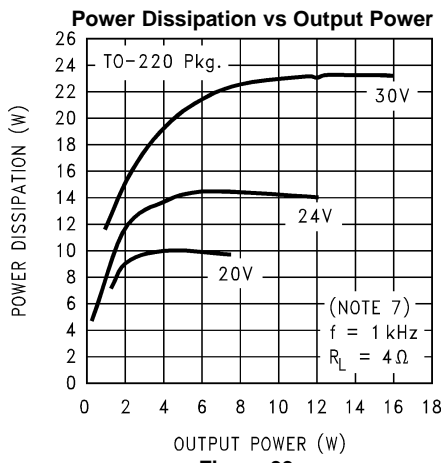

Figure 39.

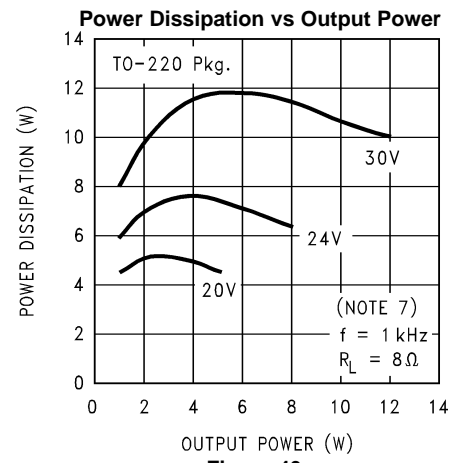

Figure 40.

TYPICAL PERFORMANCE CHARACTERISTICS (continued)

Typicals are measured at 25°C and represent the parametric norm.

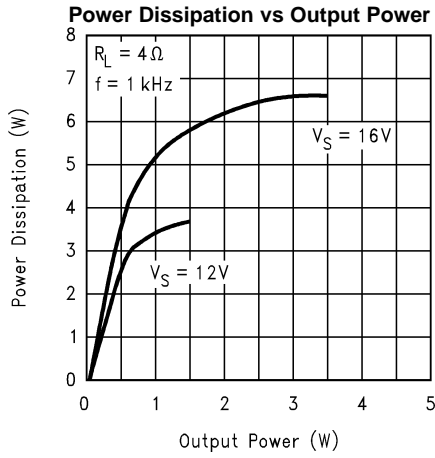

Figure 41.

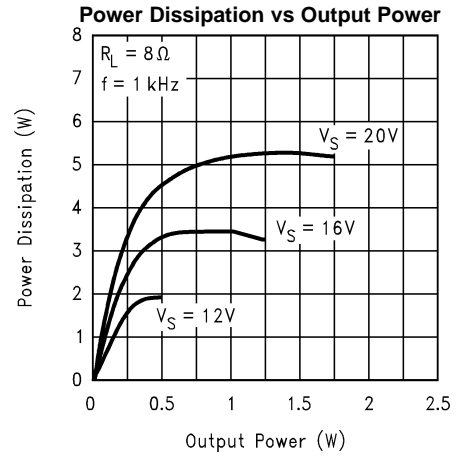

Figure 42.

APPLICATION INFORMATION

The LM4755 contains circuitry to pull down the bias line internally, effectively shutting down the input stage. An external R-C should be used to adjust the timing of the pull-down. If the bias line is pulled down too quickly, currents induced in the internal bias resistors will cause a momentary DC voltage to appear across the inputs of each amplifier's internal differential pair, resulting in an output DC shift towards V_{supply} . An R-C timing circuit should be used to limit the pull-down time such that output "pops" and signal feedthroughs will be minimized. The pull-down timing is a function of a number of factors, including the internal mute circuitry, the voltage used to activate the mute, the bias capacitor, the half-supply voltage, and internal resistances used in the half-supply generator. [Table 1](#) shows a list of recommended values for the external R-C.

Table 1. RECOMMENDED VALUES FOR MUTE CIRCUIT

| V_{MUTE} | V_{CC} | R_m | C_m |
|------------|----------|----------------|------------|
| 5V | 12V | 18 k Ω | 10 μ F |
| 5V | 15V | 18 k Ω | 10 μ F |
| 5V | 20V | 12 k Ω | 10 μ F |
| 5V | 24V | 12 k Ω | 10 μ F |
| 5V | 28V | 8.2 k Ω | 10 μ F |
| 5V | 30V | 8.2 k Ω | 10 μ F |

CAPACITOR SELECTION AND FREQUENCY RESPONSE

With the LM4755, as in all single supply amplifiers, AC coupling capacitors are used to isolate the DC voltage present at the inputs (pins 3, 7) and outputs (pins 1, 8). As mentioned earlier in the [EXTERNAL COMPONENTS DESCRIPTION](#) section these capacitors create high-pass filters with their corresponding input/output impedances. The Typical Application Circuit shown in [Figure 1](#) shows input and output capacitors of 0.1 μ F and 1,000 μ F respectively. At the input, with an 83 k Ω typical input resistance, the result is a high pass 3 dB point occurring at 19 Hz. There is another high pass filter at 39.8 Hz created with the output load resistance of 4 Ω . Careful selection of these components is necessary to ensure that the desired frequency response is obtained. The Frequency Response curves in the [TYPICAL PERFORMANCE CHARACTERISTICS](#) section show how different output coupling capacitors affect the low frequency roll-off.

OPERATING IN BRIDGE-MODE

Though designed for use as a single-ended amplifier, the LM4755 can be used to drive a load differentially (bridge-mode). Due to the low pin count of the package, only the non-inverting inputs are available. An inverted signal must be provided to one of the inputs. This can easily be done with the use of an inexpensive op-amp configured as a standard inverting amplifier. An LF353 is a good low-cost choice. Care must be taken, however, for a bridge-mode amplifier must theoretically dissipate four times the power of a single-ended type. The load seen by each amplifier is effectively half that of the actual load being used, thus an amplifier designed to drive a 4 Ω load in single-ended mode should drive an 8 Ω load when operating in bridge-mode.

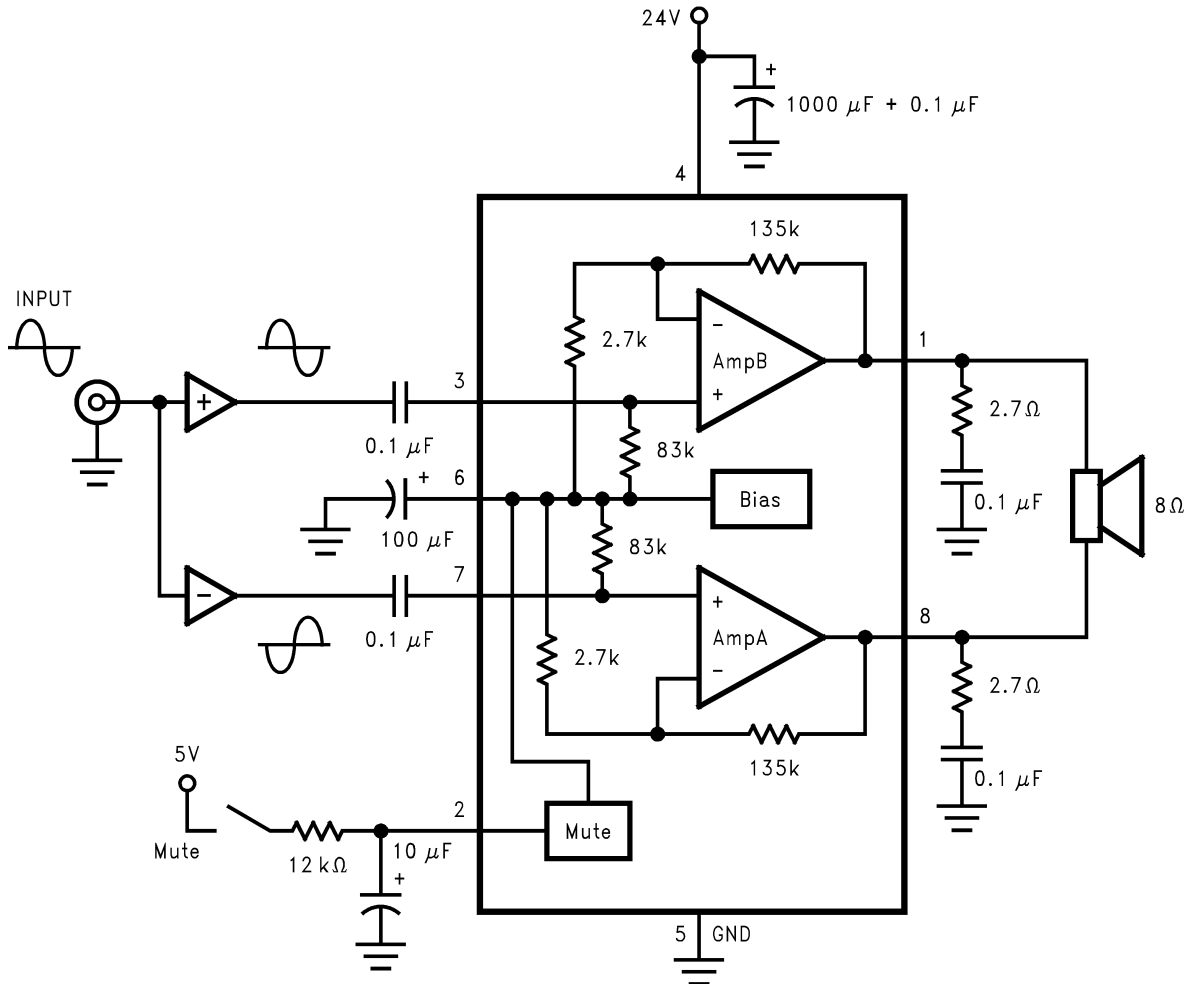

Figure 43. Bridge-Mode Application

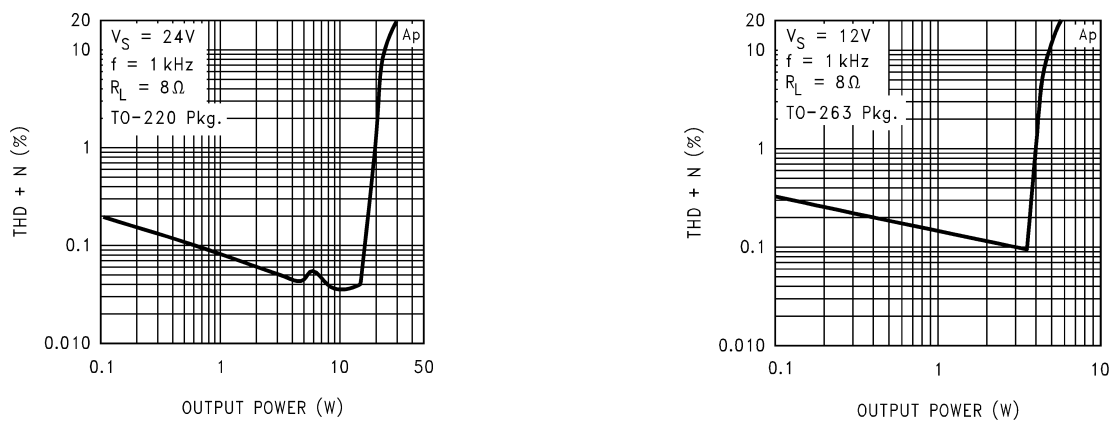

Figure 44. THD+N vs P_{OUT} for Bridge-Mode Application

PREVENTING OSCILLATIONS

With the integration of the feedback and bias resistors on-chip, the LM4755 fits into a very compact package. However, due to the close proximity of the non-inverting input pins to the corresponding output pins, the inputs should be AC terminated at all times. If the inputs are left floating, the amplifier will have a positive feedback path through high impedance coupling, resulting in a high frequency oscillation. In most applications, this termination is typically provided by the previous stage's source impedance. If the application will require an external signal, the inputs should be terminated to ground with a resistance of 50 kΩ or less on the AC side of the input coupling capacitors.

UNDERVOLTAGE SHUTDOWN

If the power supply voltage drops below the minimum operating supply voltage, the internal under-voltage detection circuitry pulls down the half-supply bias line, shutting down the preamp section of the LM4755. Due to the wide operating supply range of the LM4755, the threshold is set to just under 9V. There may be certain applications where a higher threshold voltage is desired. One example is a design requiring a high operating supply voltage, with large supply and bias capacitors, and there is little or no other circuitry connected to the main power supply rail. In this circuit, when the power is disconnected, the supply and bias capacitors will discharge at a slower rate, possibly resulting in audible output distortion as the decaying voltage begins to clip the output signal. An external circuit may be used to sense for the desired threshold, and pull the bias line (pin 6) to ground to disable the input preamp. Figure 45 shows an example of such a circuit. When the voltage across the zener diode drops below its threshold, current flow into the base of Q1 is interrupted. Q2 then turns on, discharging the bias capacitor. This discharge rate is governed by several factors, including the bias capacitor value, the bias voltage, and the resistor at the emitter of Q2. An equation for approximating the value of the emitter discharge resistor, R, is given below:

$$R = (0.7V) / (Cb \cdot (V_{CC}/2) / 0.1s) \quad (1)$$

Note that this is only a linearized approximation based on a discharge time of 0.1s. The circuit should be evaluated and adjusted for each application.

As mentioned earlier in the [Built-in Mute Circuit](#) section, when using an external circuit to pull down the bias line, the rate of discharge will have an effect on the turn-off induced distortions. Please refer to the [Table 1](#) section for more information.

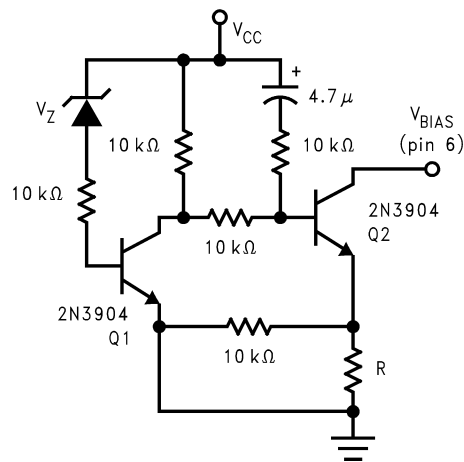

Figure 45. External Undervoltage Pull-Down

THERMAL CONSIDERATIONS

Heat Sinking

Proper heatsinking is necessary to ensure that the amplifier will function correctly under all operating conditions. A heatsink that is too small will cause the die to heat excessively and will result in a degraded output signal as the thermal protection circuitry begins to operate.

The choice of a heatsink for a given application is dictated by several factors: the maximum power the IC needs to dissipate, the worst-case ambient temperature of the circuit, the junction-to-case thermal resistance, and the maximum junction temperature of the IC. The heat flow approximation equation used in determining the correct heatsink maximum thermal resistance is given below:

$$T_J - T_A = P_{DMAX} \cdot (\theta_{JC} + \theta_{CS} + \theta_{SA})$$

where

- P_{DMAX} = maximum power dissipation of the IC
- $T_J(^{\circ}\text{C})$ = junction temperature of the IC
- $T_A(^{\circ}\text{C})$ = ambient temperature
- $\theta_{JC}(^{\circ}\text{C}/\text{W})$ = junction-to-case thermal resistance of the IC
- $\theta_{CS}(^{\circ}\text{C}/\text{W})$ = case-to-heatsink thermal resistance (typically 0.2 to 0.5 $^{\circ}\text{C}/\text{W}$)
- $\theta_{SA}(^{\circ}\text{C}/\text{W})$ = thermal resistance of heatsink (2)

When determining the proper heatsink, the above equation should be re-written as:

$$\theta_{SA} \leq [(T_J - T_A) / P_{DMAX}] - \theta_{JC} - \theta_{CS} \quad (3)$$

DDPAK HEATSINKING

Surface mount applications will be limited by the thermal dissipation properties of printed circuit board area. The DDPACK package is not recommended for surface mount applications with $V_S > 16\text{V}$ due to limited printed circuit board area. There are DDPACK package enhancements, such as clip-on heatsinks and heatsinks with adhesives, that can be used to improve performance.

Standard FR-4 single-sided copper clad will have an approximate Thermal resistance (θ_{SA}) ranging from:

| | | |
|-------------------|-----------------------------------|---|
| 1.5 × 1.5 in. sq. | 20–27 $^{\circ}\text{C}/\text{W}$ | ($T_A=28^{\circ}\text{C}$, Sine wave testing, 1 oz. Copper) |
| 2 × 2 in. sq. | 16–23 $^{\circ}\text{C}/\text{W}$ | |

The above values for θ_{SA} vary widely due to dimensional proportions (i.e. variations in width and length will vary θ_{SA}).

For audio applications, where peak power levels are short in duration, this part will perform satisfactory with less heatsinking/copper clad area. As with any high power design proper bench testing should be undertaken to assure the design can dissipate the required power. Proper bench testing requires attention to worst case ambient temperature and air flow. At high power dissipation levels the part will show a tendency to increase saturation voltages, thus limiting the undistorted power levels.

DETERMINING MAXIMUM POWER DISSIPATION

For a single-ended class AB power amplifier, the theoretical maximum power dissipation point is a function of the supply voltage, V_S , and the load resistance, R_L and is given by the following equation:

(single channel)

$$P_{DMAX} (W) = [V_S^2 / (2 \cdot \pi^2 \cdot R_L)]$$

The above equation is for a single channel class-AB power amplifier. For dual amplifiers such as the LM4755, the equation for calculating the total maximum power dissipated is:

(dual channel)

$$P_{DMAX} (W) = 2 \cdot [V_S^2 / (2 \cdot \pi^2 \cdot R_L)]$$

or

$$V_S^2 / (\pi^2 \cdot R_L)$$

(Bridged Outputs)

$$P_{DMAX} (W) = 4[V_S^2 / (2\pi^2 \cdot R_L)]$$

HEATSINK DESIGN EXAMPLE

Determine the system parameters:

| | |
|--------------------|--------------------------------|
| $V_S = 24V$ | Operating Supply Voltage |
| $R_L = 4\Omega$ | Minimum Load Impedance |
| $T_A = 55^\circ C$ | Worst Case Ambient Temperature |

Device parameters from the datasheet:

| | |
|-----------------------------|-------------------------------------|
| $T_J = 150^\circ C$ | Maximum Junction Temperature |
| $\theta_{JC} = 2^\circ C/W$ | Junction-to-Case Thermal Resistance |

Calculations:

$$2 \cdot P_{DMAX} = 2 \cdot [V_S^2 / 2 \cdot \pi^2 \cdot R_L] = (24V)^2 / (2 \cdot \pi^2 \cdot 4\Omega) = 14.6W$$

$$\theta_{SA} \leq [(T_J - T_A) / P_{DMAX}] - \theta_{JC} - \theta_{CS} = [(150^\circ C - 55^\circ C) / 14.6W] - 2^\circ C/W - 0.2^\circ C/W = 4.3^\circ C/W$$

Conclusion: Choose a heatsink with $\theta_{SA} \leq 4.3^\circ C/W$.

DDPAK HEATSINK DESIGN EXAMPLES

Example 1: (Stereo Single-Ended Output)

Given: $T_A = 30^\circ C$

$$T_J = 150^\circ C$$

$$R_L = 4\Omega$$

$$V_S = 12V$$

$$\theta_{JC} = 2^\circ C/W$$

P_{DMAX} from P_D vs P_O Graph:

$$P_{DMAX} \approx 3.7W \quad (4)$$

Calculating P_{DMAX} :

$$P_{DMAX} = V_{CC}^2 / (\pi^2 R_L) = (12V)^2 / \pi^2 (4\Omega) = 3.65W \quad (5)$$

Calculating Heatsink Thermal Resistance:

$$\theta_{SA} < T_J - T_A / P_{DMAX} - \theta_{JC} - \theta_{CS} \quad (6)$$

$$\theta_{SA} < 120^\circ C / 3.7W - 2.0^\circ C/W - 0.2^\circ C/W = 30.2^\circ C/W \quad (7)$$

Therefore the recommendation is to use 1.5 × 1.5 square inch of single-sided copper clad.

Example 2: (Stereo Single-Ended Output)

Given: $T_A = 50^\circ C$

$$T_J = 150^\circ C$$

$$R_L = 4\Omega$$

$$V_S = 12V$$

$$\theta_{JC} = 2^\circ C/W$$

P_{DMAX} from P_D vs P_O Graph:

$$P_{DMAX} \approx 3.7W \quad (8)$$

Calculating P_{DMAX} :

$$P_{DMAX} = V_{CC}^2 / (\pi^2 R_L) = (12V)^2 / \pi^2 (4\Omega) = 3.65W \quad (9)$$

Calculating Heatsink Thermal Resistance:

$$\theta_{SA} < [(T_J - T_A) / P_{DMAX}] - \theta_{JC} - \theta_{CS} \quad (10)$$

$$\theta_{SA} < 100^{\circ}\text{C}/3.7\text{W} - 2.0^{\circ}\text{C}/\text{W} - 0.2^{\circ}\text{C}/\text{W} = 24.8^{\circ}\text{C}/\text{W} \quad (11)$$

Therefore the recommendation is to use 2.0 × 2.0 square inch of single-sided copper clad.

Example 3: (Bridged Output)

Given: $T_A=50^{\circ}\text{C}$

$$T_J=150^{\circ}\text{C}$$

$$R_L=8\Omega$$

$$V_S=12\text{V}$$

$$\theta_{JC}=2^{\circ}\text{C}/\text{W}$$

Calculating $P_{D\text{MAX}}$:

$$P_{D\text{MAX}} = 4[V_{CC}^2/(2\pi^2R_L)] = 4(12\text{V})^2/(2\pi^2(8\Omega)) = 3.65\text{W} \quad (12)$$

Calculating Heatsink Thermal Resistance:

$$\theta_{SA} < [(T_J - T_A) / P_{D\text{MAX}}] - \theta_{JC} - \theta_{CS} \quad (13)$$

$$\theta_{SA} < 100^{\circ}\text{C} / 3.7\text{W} - 2.0^{\circ}\text{C}/\text{W} - 0.2^{\circ}\text{C}/\text{W} = 24.8^{\circ}\text{C}/\text{W} \quad (14)$$

Therefore the recommendation is to use 2.0 × 2.0 square inch of single-sided copper clad.

LAYOUT AND GROUND RETURNS

Proper PC board layout is essential for good circuit performance. When laying out a PC board for an audio power amplifier, particular attention must be paid to the routing of the output signal ground returns relative to the input signal and bias capacitor grounds. To prevent any ground loops, the ground returns for the output signals should be routed separately and brought together at the supply ground. The input signal grounds and the bias capacitor ground line should also be routed separately. The 0.1 μF high frequency supply bypass capacitor should be placed as close as possible to the IC.

PC BOARD LAYOUT-COMPOSITE

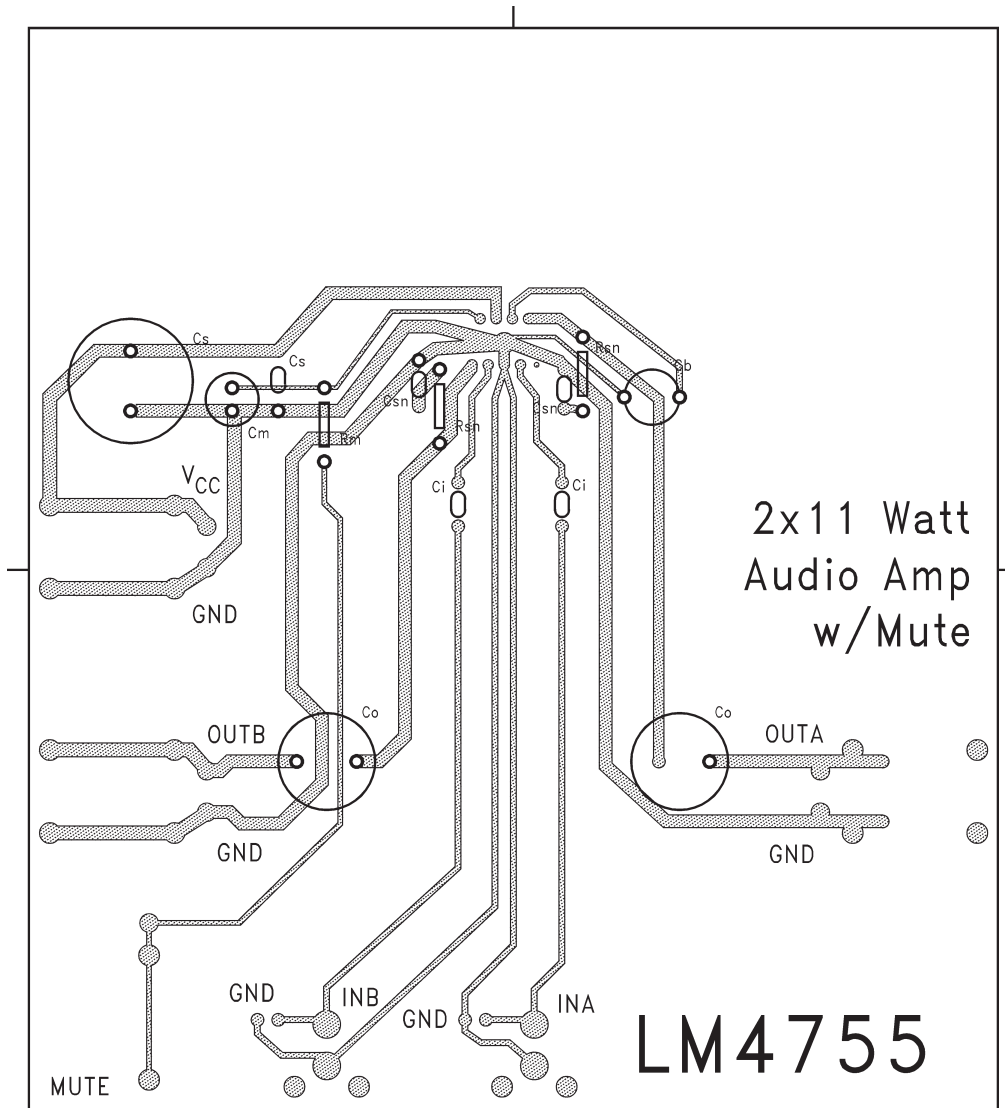

Figure 46.

PC BOARD LAYOUT-SILK SCREEN

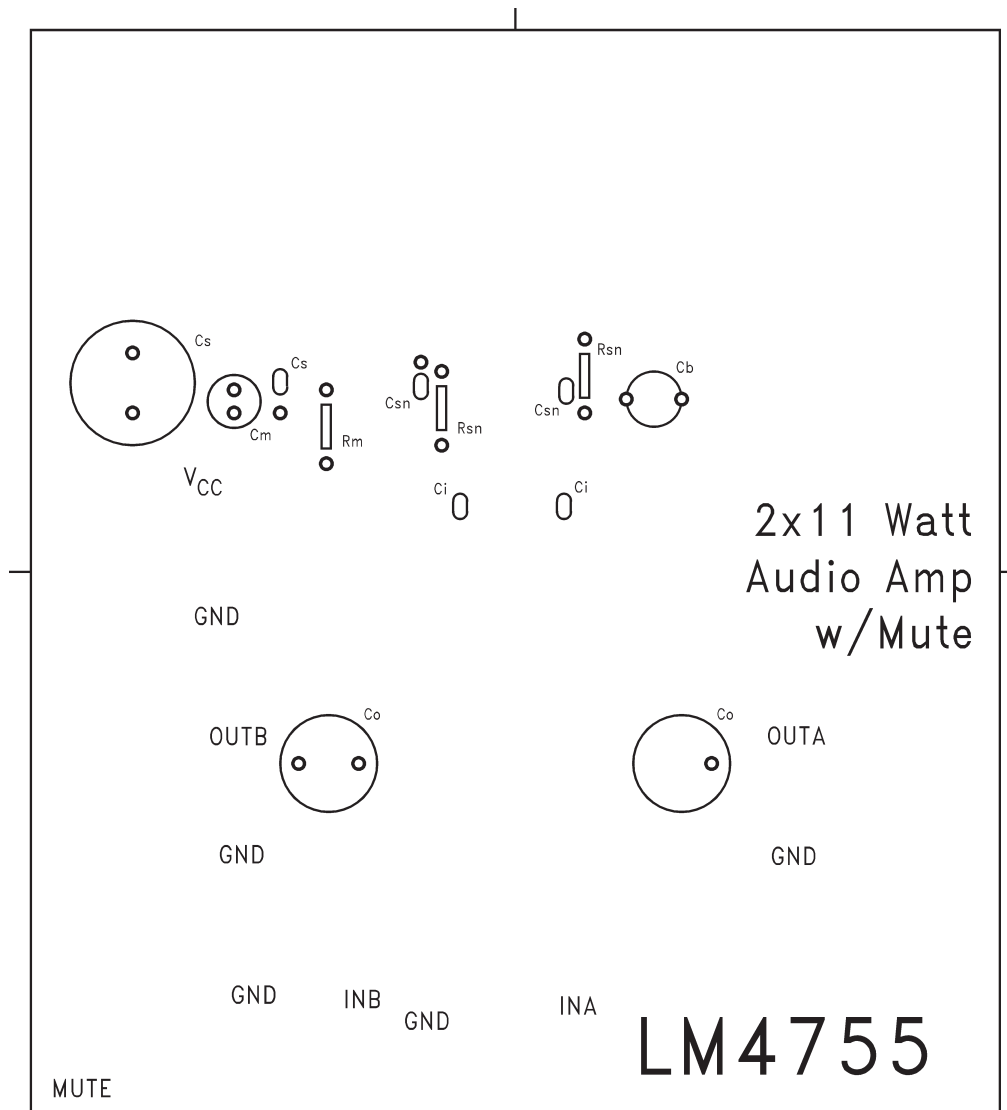

Figure 47.

PC BOARD LAYOUT-SOLDER SIDE

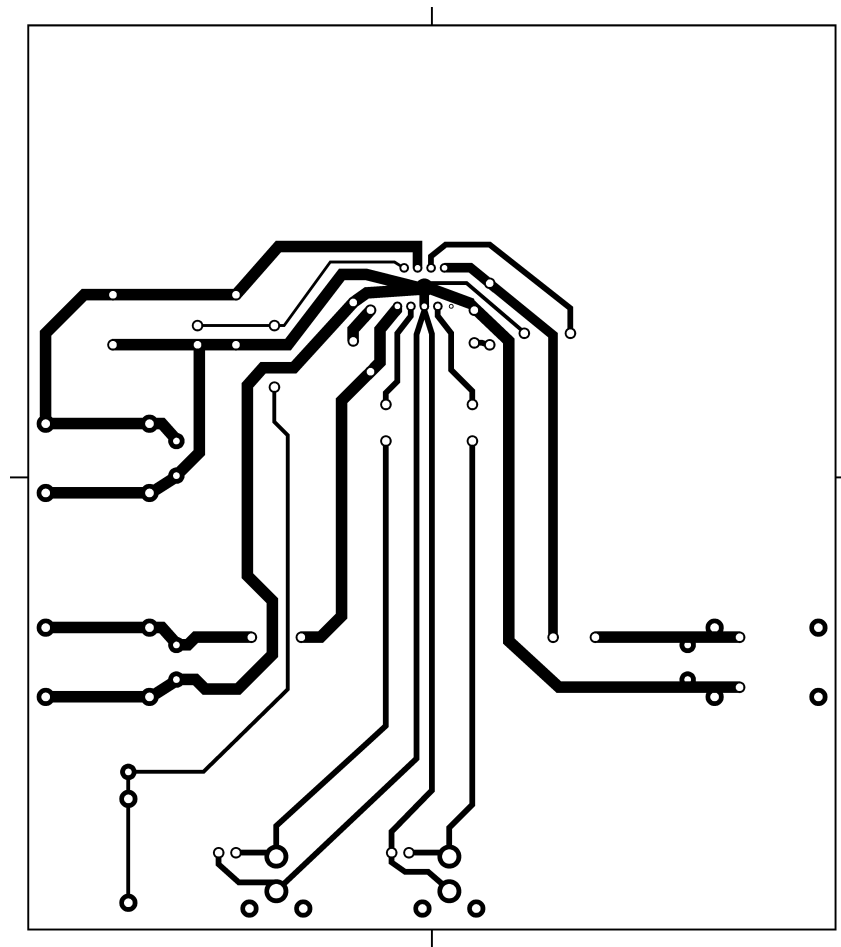

Figure 48.

REVISION HISTORY

| Changes from Revision D (April 2013) to Revision E | Page |
|--|--------------------------|
| <hr/> <ul style="list-style-type: none">• Changed layout of National Data Sheet to TI format | <hr/> 22 |

PACKAGING INFORMATION

| Orderable Device | Status (1) | Package Type | Package Drawing | Pins | Package Qty | Eco Plan (2) | Lead/Ball Finish (6) | MSL Peak Temp (3) | Op Temp (°C) | Device Marking (4/5) | Samples |
|------------------|---------------|------------------|-----------------|------|-------------|----------------------------|-------------------------|----------------------|--------------|-------------------------|-------------------------|
| LM4755TSX/NOPB | ACTIVE | DDPAK/ TO-263 | KTW | 9 | 500 | Green (RoHS & no Sb/Br) | SN | Level-3-245C-168 HR | -20 to 80 | LM4755TS | Samples |

(1) The marketing status values are defined as follows:

ACTIVE: Product device recommended for new designs.

LIFEBUY: TI has announced that the device will be discontinued, and a lifetime-buy period is in effect.

NRND: Not recommended for new designs. Device is in production to support existing customers, but TI does not recommend using this part in a new design.

PREVIEW: Device has been announced but is not in production. Samples may or may not be available.

OBSOLETE: TI has discontinued the production of the device.

(2) **RoHS:** TI defines "RoHS" to mean semiconductor products that are compliant with the current EU RoHS requirements for all 10 RoHS substances, including the requirement that RoHS substance do not exceed 0.1% by weight in homogeneous materials. Where designed to be soldered at high temperatures, "RoHS" products are suitable for use in specified lead-free processes. TI may reference these types of products as "Pb-Free".

RoHS Exempt: TI defines "RoHS Exempt" to mean products that contain lead but are compliant with EU RoHS pursuant to a specific EU RoHS exemption.

Green: TI defines "Green" to mean the content of Chlorine (Cl) and Bromine (Br) based flame retardants meet JS709B low halogen requirements of <=1000ppm threshold. Antimony trioxide based flame retardants must also meet the <=1000ppm threshold requirement.

(3) MSL, Peak Temp. - The Moisture Sensitivity Level rating according to the JEDEC industry standard classifications, and peak solder temperature.

(4) There may be additional marking, which relates to the logo, the lot trace code information, or the environmental category on the device.

(5) Multiple Device Markings will be inside parentheses. Only one Device Marking contained in parentheses and separated by a "~" will appear on a device. If a line is indented then it is a continuation of the previous line and the two combined represent the entire Device Marking for that device.

(6) Lead/Ball Finish - Orderable Devices may have multiple material finish options. Finish options are separated by a vertical ruled line. Lead/Ball Finish values may wrap to two lines if the finish value exceeds the maximum column width.

Important Information and Disclaimer:The information provided on this page represents TI's knowledge and belief as of the date that it is provided. TI bases its knowledge and belief on information provided by third parties, and makes no representation or warranty as to the accuracy of such information. Efforts are underway to better integrate information from third parties. TI has taken and continues to take reasonable steps to provide representative and accurate information but may not have conducted destructive testing or chemical analysis on incoming materials and chemicals. TI and TI suppliers consider certain information to be proprietary, and thus CAS numbers and other limited information may not be available for release.

In no event shall TI's liability arising out of such information exceed the total purchase price of the TI part(s) at issue in this document sold by TI to Customer on an annual basis.

TAPE AND REEL INFORMATION



QUADRANT ASSIGNMENTS FOR PIN 1 ORIENTATION IN TAPE



*All dimensions are nominal

| Device | Package Type | Package Drawing | Pins | SPQ | Reel Diameter (mm) | Reel Width W1 (mm) | A0 (mm) | B0 (mm) | K0 (mm) | P1 (mm) | W (mm) | Pin1 Quadrant |
|----------------|------------------|-----------------|------|-----|--------------------|--------------------|---------|---------|---------|---------|--------|---------------|
| LM4755TSX/NOPB | DDPAK/ TO-263 | KTW | 9 | 500 | 330.0 | 24.4 | 10.75 | 14.85 | 5.0 | 16.0 | 24.0 | Q2 |

TAPE AND REEL BOX DIMENSIONS



*All dimensions are nominal

| Device | Package Type | Package Drawing | Pins | SPQ | Length (mm) | Width (mm) | Height (mm) |
|----------------|--------------|-----------------|------|-----|-------------|------------|-------------|
| LM4755TSX/NOPB | DDPAK/TO-263 | KTW | 9 | 500 | 367.0 | 367.0 | 45.0 |

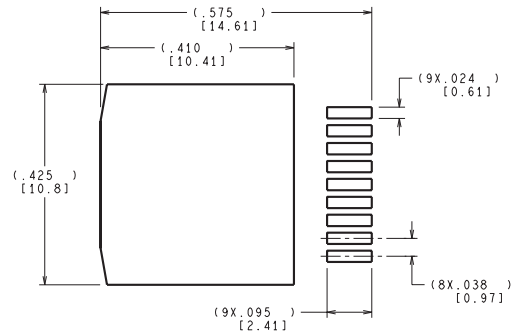
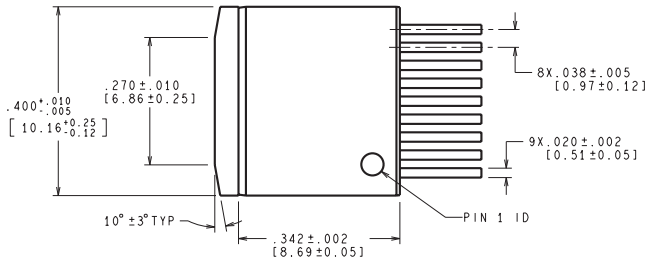
KTW0009A

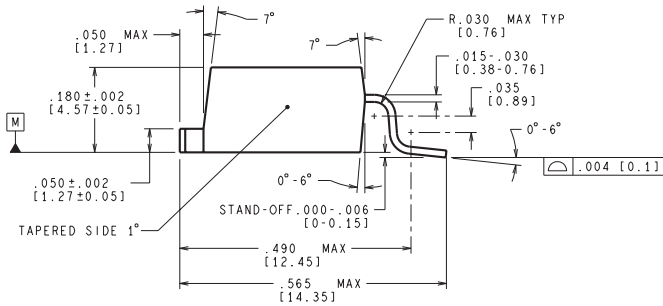

RECOMMENDED LAND PATTERN



CONTROLLING DIMENSION: INCH
DIMENSIONS IN () ARE MILLIMETERS

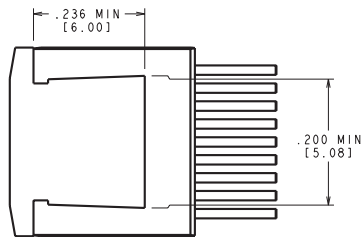

BOTTOM SIDE OF PACKAGE

TS9A (Rev B)

IMPORTANT NOTICE AND DISCLAIMER

TI PROVIDES TECHNICAL AND RELIABILITY DATA (INCLUDING DATASHEETS), DESIGN RESOURCES (INCLUDING REFERENCE DESIGNS), APPLICATION OR OTHER DESIGN ADVICE, WEB TOOLS, SAFETY INFORMATION, AND OTHER RESOURCES "AS IS" AND WITH ALL FAULTS, AND DISCLAIMS ALL WARRANTIES, EXPRESS AND IMPLIED, INCLUDING WITHOUT LIMITATION ANY IMPLIED WARRANTIES OF MERCHANTABILITY, FITNESS FOR A PARTICULAR PURPOSE OR NON-INFRINGEMENT OF THIRD PARTY INTELLECTUAL PROPERTY RIGHTS.

These resources are intended for skilled developers designing with TI products. You are solely responsible for (1) selecting the appropriate TI products for your application, (2) designing, validating and testing your application, and (3) ensuring your application meets applicable standards, and any other safety, security, or other requirements. These resources are subject to change without notice. TI grants you permission to use these resources only for development of an application that uses the TI products described in the resource. Other reproduction and display of these resources is prohibited. No license is granted to any other TI intellectual property right or to any third party intellectual property right. TI disclaims responsibility for, and you will fully indemnify TI and its representatives against, any claims, damages, costs, losses, and liabilities arising out of your use of these resources.

TI's products are provided subject to TI's Terms of Sale (www.ti.com/legal/termsofsale.html) or other applicable terms available either on ti.com or provided in conjunction with such TI products. TI's provision of these resources does not expand or otherwise alter TI's applicable warranties or warranty disclaimers for TI products.

Mailing Address: Texas Instruments, Post Office Box 655303, Dallas, Texas 75265
Copyright © 2020, Texas Instruments Incorporated