



EVQ4425A-QB-00A

High Efficiency 1.5A, 36V, 2.2MHz Synchronous Step-Down LED Driver Evaluation Board

DESCRIPTION

The EVQ4425A-QB-00A is an evaluation board for the MP/MPQ4425A.

MP/MPQ4425A is a high-efficiency, synchronous, rectified, step-down, switch-mode white LED driver with built-in power MOSFETs. It offers a very compact solution to achieve a 1.5A continuous output current with excellent load and line regulation over a wide input supply range. The MP/MPQ4425A has synchronous mode operation to get high efficiency.

The EVQ4425A-QB-00A is a fully assembled and tested evaluation board, which generates load current up to 1.5A from a 4V to 36V input range.

ELECTRICAL SPECIFICATION

Parameter	Symbol	Value	Units
Input Voltage	V_{IN} , V_{EMI}	4 - 36	V
Output Current	I_{OUT}	1.5	A

FEATURES

- Wide 4V to 36V Operating Input Range
- 85mΩ High-Side, 50mΩ Low-Side Internal Power MOSFETs
- High-Efficiency Synchronous Mode Operation
- Default 2.2MHz Switching Frequency
- PWM Dimming (Min 100Hz Dimming Frequency)
- Force CCM Mode
- 0.2V Reference Voltage
- Internal Soft-Start
- Fault Indication for LED Short, Open and Thermal Shutdown
- Over-Current Protection (OCP) with Valley-Current Detection
- Proprietary Switching-Loss-Reduction Technology
- Thermal Shutdown
- Available in a QFN-13 (2.5mmx3mm) Package
- CISPR25 Class5 Compliant
- AEC-Q100 Grade-1

APPLICATIONS

- Automotive LED Lighting

All MPS parts are lead-free, halogen free, and adhere to the RoHS directive. For MPS green status, please visit MPS website under Quality Assurance. "MPS" and "The Future of Analog IC Technology" are Registered Trademarks of Monolithic Power Systems, Inc.

EVQ4425A-QB-00A EVALUATION BOARD



(L × W × H) 6.35cm x 6.35cm x 1.3cm

Board Number	MPS IC Number
EVQ4425A-QB-00A	MP/MPQ4425A

Efficiency vs. LED Current

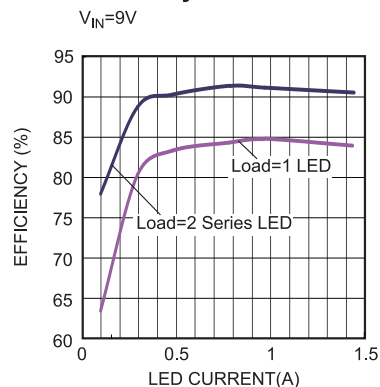

EVALUATION BOARD SCHEMATIC

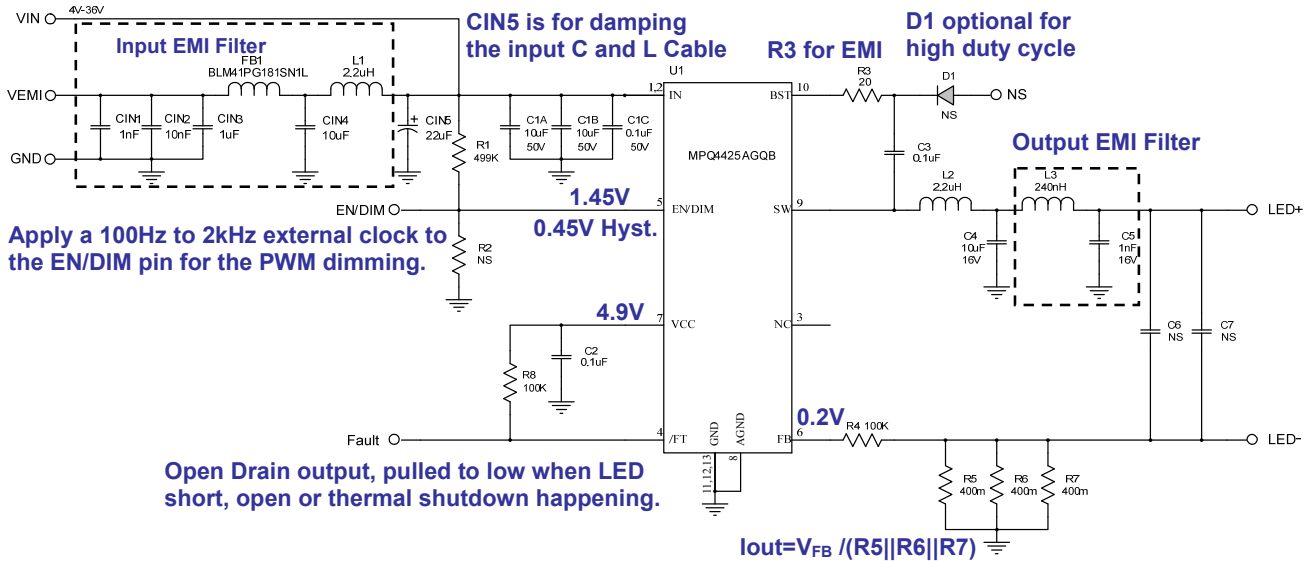

Package Reference

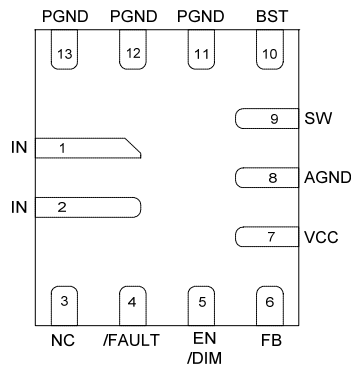

EVQ4425A-QB-00A BILL OF MATERIALS

Qty	Ref	Value	Description	Package	Manufacture	Manufacture_PN
2	CIN1, C5	1nF	Ceramic Cap., 50V, X7R	0603	muRata	GRM188R71H102KA01D
1	CIN2	10nF	Ceramic Cap., 50V, X7R	0603	muRata	GRM188R71H103KA01D
1	CIN3	1μF	Ceramic Cap., 50V, X7R	1206	muRata	GRM31MR71H105KA88L
1	CIN4	10μF	Ceramic Cap., 50V, X7R	1210	muRata	GRM32ER71H106KA12L
1	CIN5	22μF	Electrolytic Cap., 63V	SMD	Jianghai	VTD-63V22
2	C1A, C1B	10μF	Ceramic Cap., 50V, X5R	1206	muRata	GRM31CR61H106KA12L
1	C1C	0.1μF	Ceramic Cap., 50V, X7R	0603	muRata	GRM188R71H104KA93D
2	C2, C3	0.1μF	Ceramic Cap., 16V, X7R	0603	muRata	GRM188R71C104KA01D
1	C4	10μF	Ceramic Cap., 16V, X7R	1210	muRata	GRM32DR71C106KA01L
2	C6, C7	NS				
1	D1	NS				
1	FB1		Bead, 180ohm at 100MHz, 3.5A	1812	muRata	BLM41PG181SN1L
2	L1, L2	2.2μH	Inductor, 82mOhm DCR, 3.3A	SMD	TOKO	DFE252012F-2R2MP2
1	L3	240nH	Inductor, 19mOhm DCR, 5A	SMD	TOKO	DFE201612E-R24MP2
1	R1	499k	Film Res., 1%	0603	Yageo	RC0603FR-07499KL
1	R3	20	Film Res., 1%	0603	Yageo	RC0603FR-0720RL
2	R4, R8	100k	Film Res., 1%	0603	Yageo	RC0603FR-07100KL
3	R5, R6, R7	400m	Film Res., 1%	1206	Yageo	RL1206FR-070R4L
1	R2	NS				
1	U1		Step-Down Regulator	QFN13(2X3)	MPS	MPQ4425AGQB
5	VIN, VEMI, GND, GND, VOUT		2.0 Golden Pin		HZ	
4	PG, GND, EN/SYNC, GND		2.54mm Test Pin		HZ	

EVB TEST RESULTS

Performance waveforms are tested on the evaluation board.

$V_{IN} = 12V$, LOAD=2 series LED, $L=2.2\mu H$, $F_{SW}=2.2MHz$, $T_A = +25^\circ C$, unless otherwise noted.⁽¹⁾

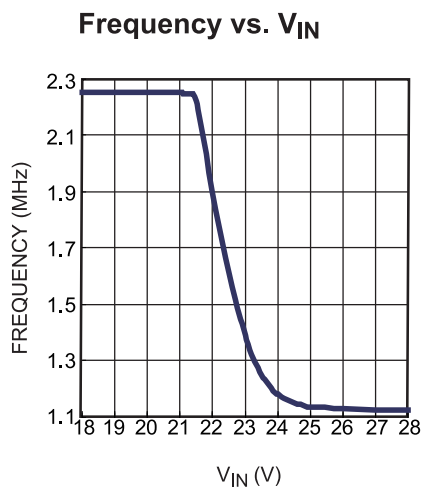
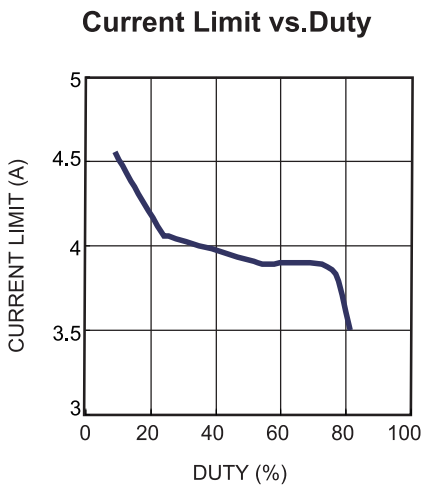
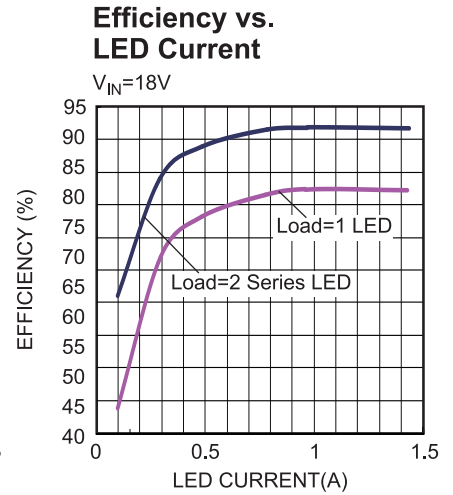
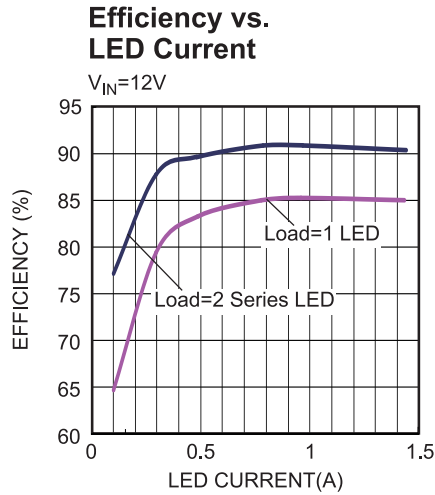
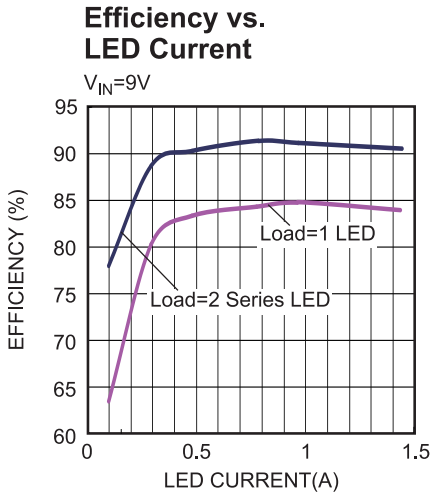

Note:

1). All the efficiency curves are tested on EVB without input and output filters.

EVB TEST RESULTS (continued)

Performance waveforms are tested on the evaluation board.

$V_{IN} = 12V$, LOAD=2 series LED, $L=2.2\mu H$, $F_{SW}=2.2MHz$, $T_A = +25^\circ C$, unless otherwise noted.

Steady State
 $I_{LED} = 0A$

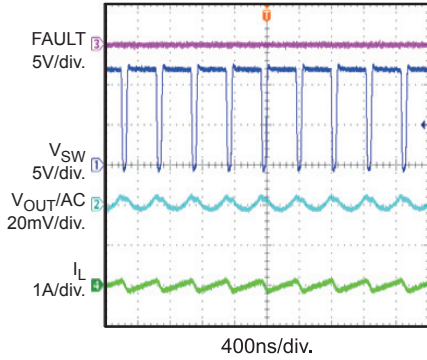

Steady State
 $I_{LED} = 1.5A$

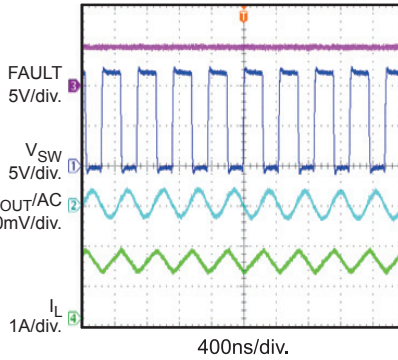

Start-Up through V_{IN}
 $I_{LED} = 0A$

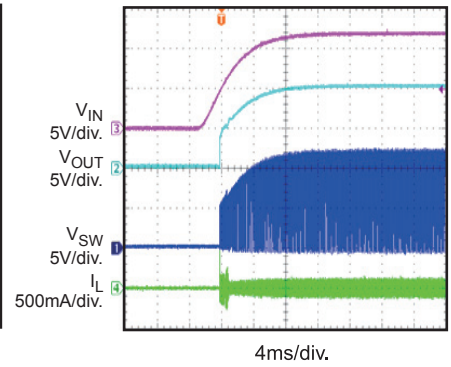

Start-Up through V_{IN}
 $I_{LED} = 1.5A$

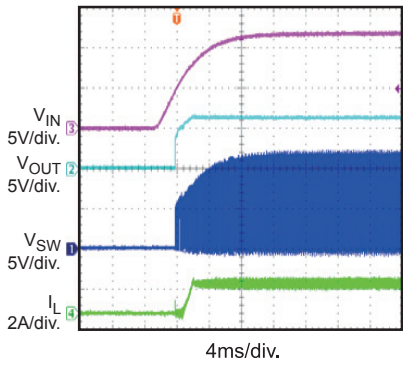

Shutdown through V_{IN}
 $I_{LED} = 0A$

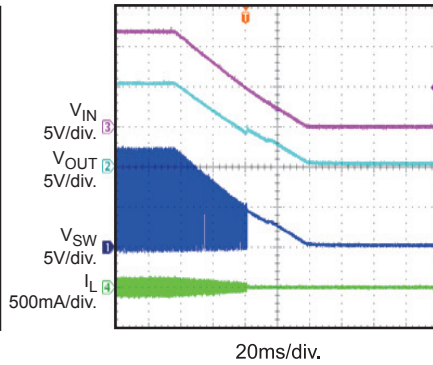

Shutdown through V_{IN}
 $I_{LED} = 1.5A$

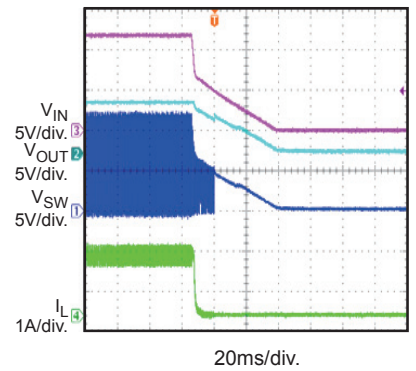

Start-Up through EN
 $I_{LED} = 0A$

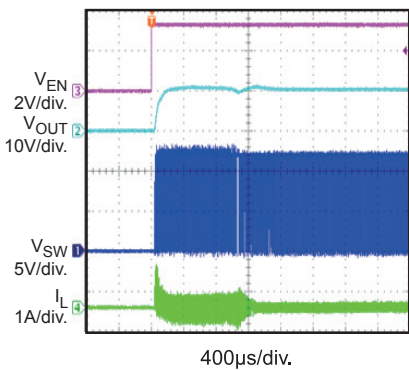

Start-Up through EN
 $I_{LED} = 1.5A$

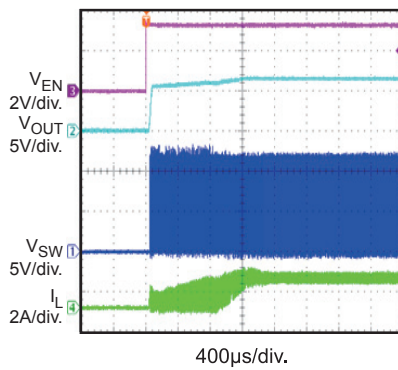

Shutdown through EN
 $I_{LED} = 1.5A$

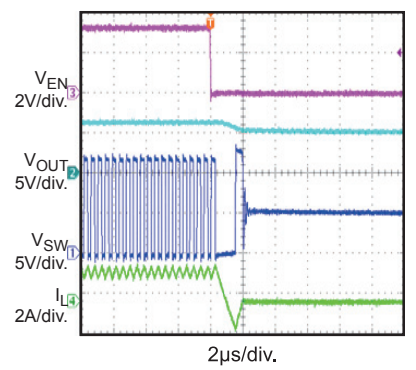

EVB TEST RESULTS (continued)

Performance waveforms are tested on the evaluation board.

 $V_{IN} = 12V$, LOAD=2 series LED, $L=2.2\mu H$, $F_{SW}=2.2MHz$, $T_A = +25^\circ C$, unless otherwise noted.

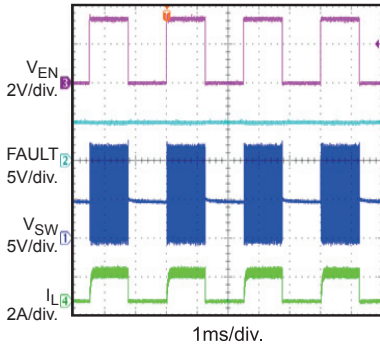
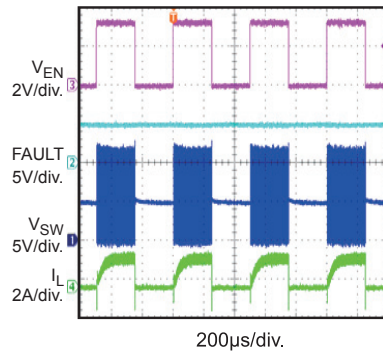
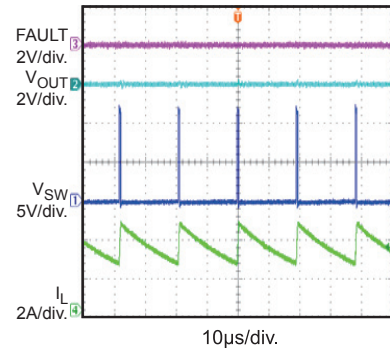
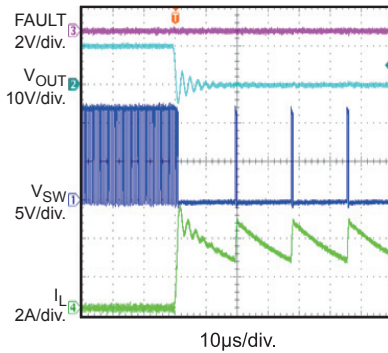
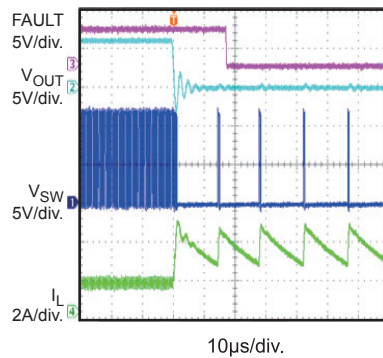
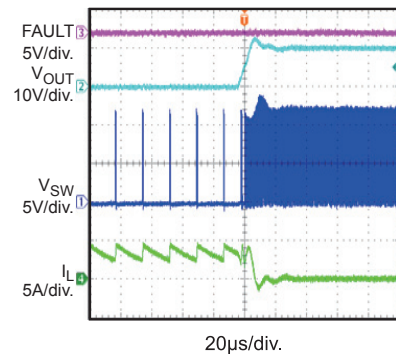
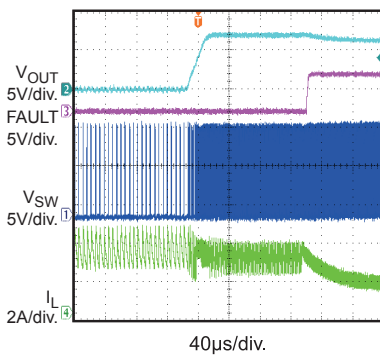
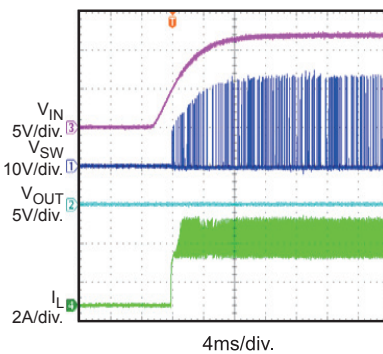
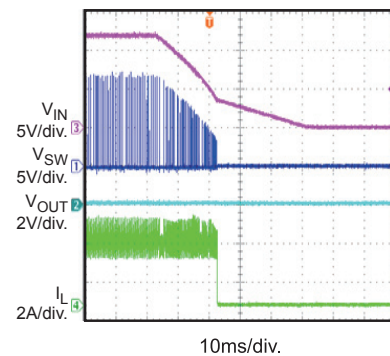
PWM Dimming
400Hz

PWM Dimming
2kHz

LED+ Short to GND
Steady State

LED+ Short to GND Entry
 $I_{LED} = 0A$

LED+ Short to GND Entry
 $I_{LED} = 1.5A$

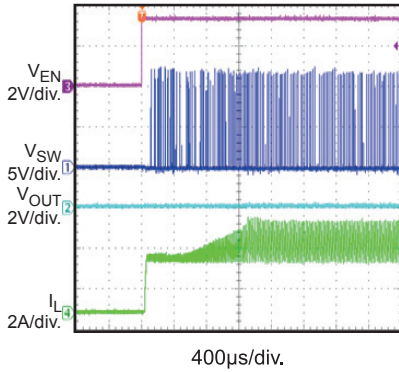
LED+ Short to GND Recovery
 $I_{LED} = 0A$

LED+ Short to GND Recovery
 $I_{LED} = 1.5A$

LED+ Short to GND
Input Power On

LED+ Short to GND
Input Power Off

EVB TEST RESULTS *(continued)*

Performance waveforms are tested on the evaluation board.

$V_{IN} = 12V$, LOAD=2 series LED, $L=2.2\mu H$, $F_{SW}=2.2MHz$, $T_A = +25^\circ C$, unless otherwise noted.

LED+ Short to GND EN On



LED+ Short to GND EN Off

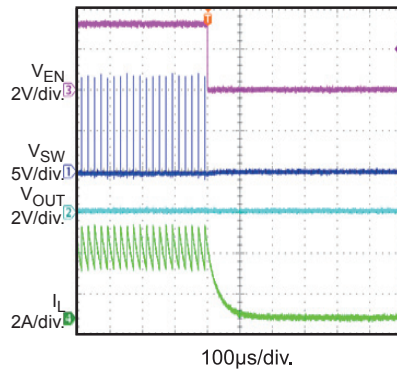

LED Open Entry

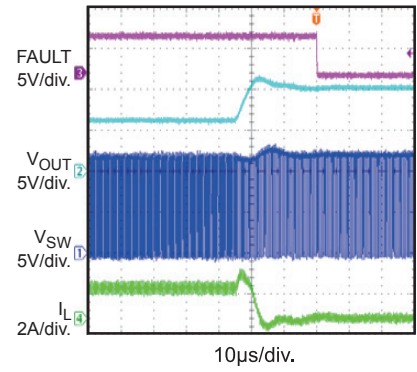

LED Open Recovery

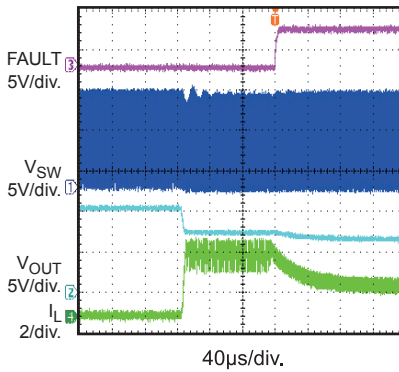

LED+ and LED- Short Entry

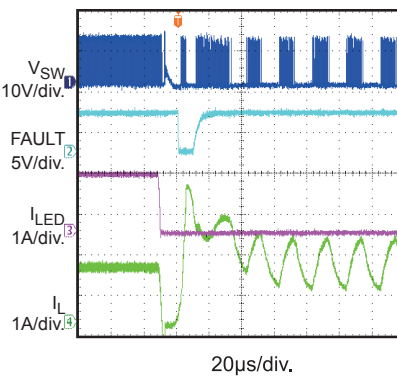

LED+ and LED- Short Recovery

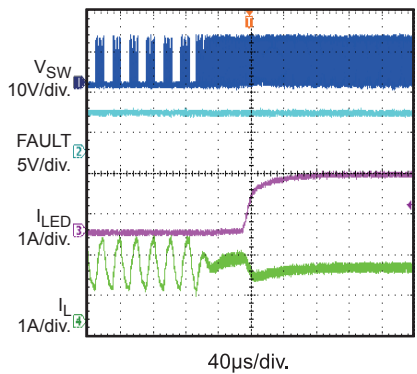

PRINTED CIRCUIT BOARD LAYOUT

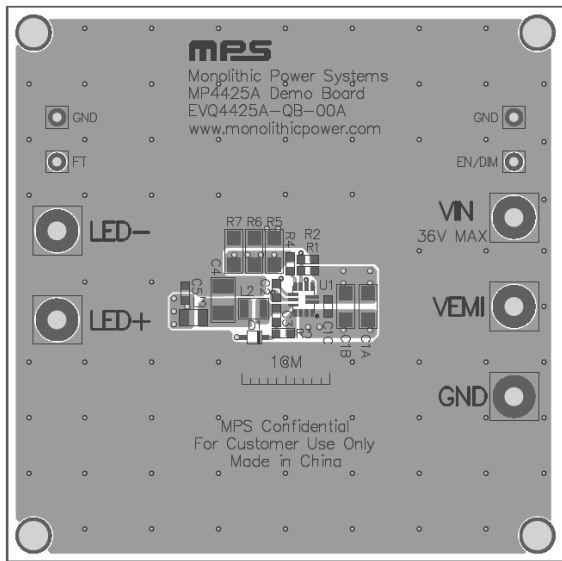

Figure 1: Top Silk and Top Layer

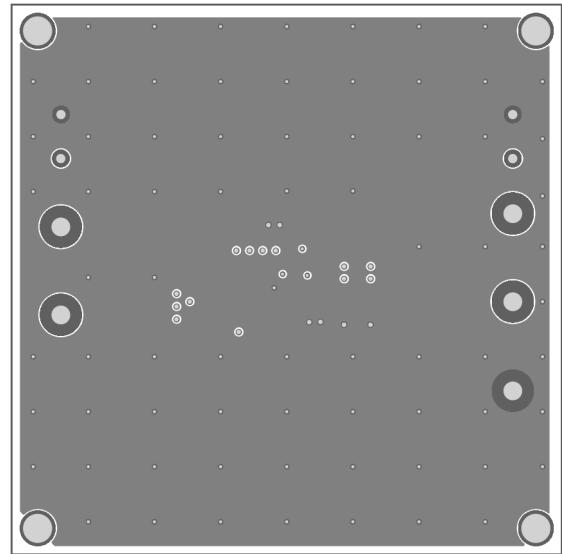

Figure 2: Inner1 Layer

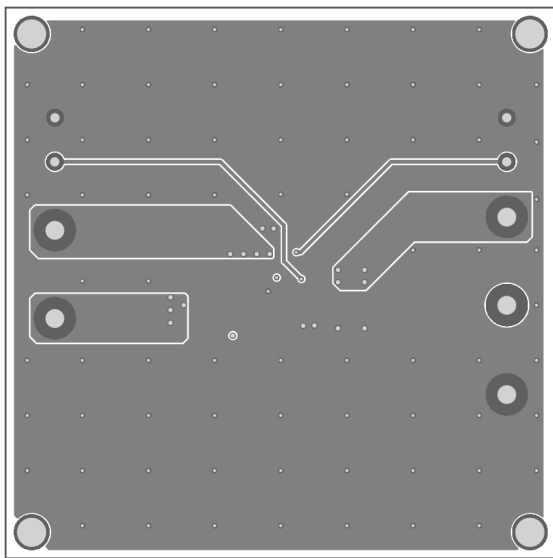

Figure 3: Inner2 Layer

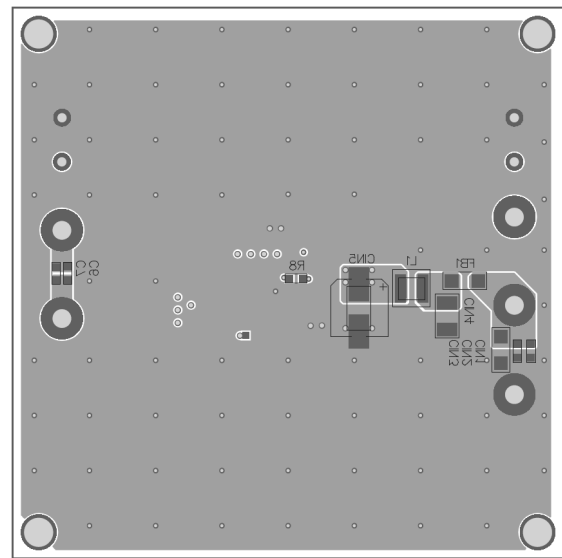

Figure 4: Bottom Silk and Bottom Layer

QUICK START GUIDE

1. Connect the positive and negative terminals of the LED to the LED+ and LED- pins, respectively.
2. Preset the power supply output to between 4 and 36V, and then turn it off.

If longer cables are used between the source and the EVB (>0.5m total), a damping capacitor should be installed at the input terminals. Especially when V_{in} is $\geq 24V$.

3. Connect the positive and negative terminals of the power supply output to the VIN and GND pins, respectively. To get better EMI performance, connect the input power between VEMI and GND.
4. Turn the power supply on. The MP/MPQ4425AGQB will automatically startup.
5. To use the Enable function, apply a digital input to the EN pin. Drive EN higher than 1.45V to turn on the regulator, drive EN less than 1V to turn it off.
6. To use the Dimming function, apply a 100Hz to 2kHz external clock to the EN/DIM pin for the PWM dimming.
7. The output current is set by the external resistor R_{FB} , Feedback reference voltage is 0.2V, I_{LED} is then given by below equation:

$$I_{LED} = \frac{0.2V}{R_{FB}}$$

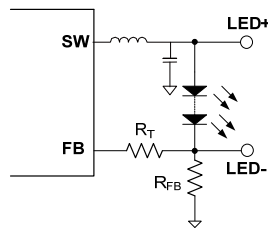

8. R_T is used to set the loop bandwidth. Basically, lower R_T , higher bandwidth. But high bandwidth may cause insufficient phase margin, resulting in loop unstable. So a proper value of R_T is needed to make a trade-off between bandwidth and phase margin. Below table lists the recommended feedback resistor and R_T values for common output with 1 or 2 series LED.

I_{LED} (A)	R_{FB} (m Ω)	R_T (k Ω)
0.5	400(1%)	200 (1%)
1	200(1%)	150 (1%)
1.5	133(1%)	100 (1%)

NOTICE: The information in this document is subject to change without notice. Please contact MPS for current specifications. Users should warrant and guarantee that third party Intellectual Property rights are not infringed upon when integrating MPS products into any application. MPS will not assume any legal responsibility for any said applications.