

Using the PWR091EVM Dual-Output DC/DC Analog With PMBus Interface

User's Guide



Literature Number: SLVU638

January 2012

1	Description	7
1.1	Typical Applications	7
1.2	Features	7
2	Electrical Performance Specifications	8
3	Schematic	9
4	Test Setup	10
4.1	Test and Configuration Software	10
4.2	Test Equipment	10
4.3	Recommended Test Setup	11
4.4	USB Interface Adapter and Cable	12
4.5	List of Test Points	12
5	EVM Configuration Using the Fusion GUI	14
5.1	Configuration Procedure	14
6	Test Procedure	15
6.1	Line/Load Regulation and Efficiency Measurement Procedure	15
6.2	Control Loop Gain and Phase Measurement Procedure	15
6.3	Efficiency	16
6.4	Equipment Shutdown	16
7	Performance Data and Typical Characteristic Curves	16
7.1	Efficiency	17
7.2	Load Regulation	18
7.3	Bode Plot	19
7.4	Transient Response	20
7.5	Output Ripple	22
7.6	HDRV and Switch Node Voltage	24
7.7	Turnon Waveform	25
8	EVM Assembly Drawing and PCB Layout	26
9	Bill of Materials	33
10	Screen Shots	34
10.1	Fusion GUI Screen Shots	34

List of Figures

1	PWR091EVM Schematic	9
2	PWR091EVM Recommended Test Setup	11
3	Texas Instruments USB-to-GPIO Adapter and Connections	12
4	Tip and Barrel Measurement.....	12
5	Efficiency of 1.2-V Output vs Line and Load.....	17
6	Efficiency of 3.3-V Output vs Line and Load.....	17
7	Load Regulation of 1.2-V Output	18
8	Load Regulation of 3.3-V Output	18
9	Bode Plot of 1.2-V Output at 10-A Load.....	19
10	Bode Plot of 3.3-V Output at 10-A Load.....	19
11	Transient Response of 1.2-V Output at 8 Vin, Transient is 5 A to 11 A to 5 A.....	20
12	Transient Response of 1.2-V Output at 12 Vin, Transient is 5 A to 11 A to 5 A	20
13	Transient Response of 3.3-V Output at 8 Vin, Transient is 5 A to 9 A to 5 A	21
14	Transient Response of 3.3-V Output at 12 Vin, Transient is 5 A to 9 A to 5 A.....	21
15	Output Ripple and SW Node of 1.2-V Output at 8 Vin, 20-A Output	22
16	Output Ripple and SW Node of 1.2-V Output at 12 Vin, 20-A Output.....	22
17	Output Ripple and SW Node of 3.3-V Output at 8 Vin, 15-A Output	23
18	Output Ripple and SW Node of 3.3-V Output at 12 Vin, 15-A Output.....	23
19	HDRV and SW Node of 1.2-V Output at 8 Vin, 20-A Output	24
20	HDRV and SW Node of 1.2-V Output at 12 Vin, 20-A Output.....	24
21	HDRV and SW Node of 3.3-V Output at 8-Vin, 15-A Output	24
22	HDRV and SW Node of 3.3-V Output at 12 Vin, 15-A Output.....	25
23	Turnon Waveform of 1.2-V Output at 8-V, 12-V and 14-V Input, 20-A Output	25
24	Turnon Waveform of 1.2-V Output With 0.5-V Prebias, at 8-V, 12-V and 14-V Input, 0-A Output	25
25	Turnon Waveform of 3.3-V Output at 8-V, 12-V, and 14-V Input, 15-A Output	26
26	Turnon Waveform of 3.3-V Output With 2-V Prebias, at 8-V, 12-V, and 14-V Input, 0-A Output.....	26
27	PWR091EVM Top Layer Assembly Drawing (Top View)	27
28	PWR091EVM Bottom Assembly Drawing (Bottom View)	28
29	PWR091EVM Top Copper (Top View)	29
30	PWR091EVM Internal Layer 1 (Top View).....	30
31	PWR091EVM Internal Layer 2 (Top View).....	31
32	PWR091EVM Bottom Copper (Bottom View)	32
33	First Window at Fusion Launch.....	34
34	Scan Finds Device Successfully.....	34
35	Software Launch Continued.....	34
36	Software Launch Continued.....	35
37	First Screen After Successful Launch: Configure- Limits & On/Off	35
38	Configure- Other	36
39	Configure- All.....	36
40	Configure- Limits and On/Off- On/Off Config Pop-up.....	37
41	Configure- Limits and On/Off- On/Off Config Pop-up.....	37
42	Configure- Other- Iout Cal Gain Change	38
43	Configure- All Config- On/Off Config Pop-up	38
44	Configure- <i>Store User Defaults</i>	39
45	Change Screens to Other Vout Rail	39
46	Change View Screen to Monitor Screen	40
47	Monitor Screen.....	41

48	System Dashboard	41
49	Display Change on Power Up	42
50	Faults Cleared	42
51	Status Screen	43
52	Import Project / Import Configuration File	43
53	Store Config To Memory	44
54	Data Logging	44
55	Data Logging Details	45
56	Data Log	45
57	Data Log File	46
58	PMBus Logging	46
59	PMBus Log Details	47
60	PMBus Log	47
61	PMBus Log File	48

List of Tables

1	PWR091EVM-001 Electrical Performance Specifications	8
2	The Functions of Each Test Points	13
3	Key Factory Configuration Parameters	14
4	List of Test Points for Loop Response Measurements	15
5	List of Test Points for Efficiency Measurements	16
6	PWR091 Bill of Materials	33

Using the PWR091EVM Dual-Output DC/DC Analog With PMBus Interface

The PWR091EVM evaluation module uses the TPS40422. The TPS40422 is a dual-channel, synchronous buck controller that operates from a nominal 4.5-V to 20-V supply. This controller is an analog PWM controller that allows programming and monitoring via the PMBus interface. It can be used as a dual, independent output or a dual-phase output controller.

1 Description

The PWR091EVM is designed as a dual-output converter. It uses a nominal 12-V bus to produce a regulated 1.2-V output at up to 20 A of load current, and a regulated 3.3-V output at up to 15 A of load current. The PWR091EVM demonstrates the TPS40422 in a typical low-voltage application while providing a number of test points to evaluate the performance of the TPS40422.

1.1 Typical Applications

- Smart power systems
- Power supply modules
- Communications equipment
- Computing equipment

1.2 Features

- Regulated 1.2-V output up to 20-Adc, steady-state output current
- Regulated 3.3-V output up to 15-Adc, steady-state output current
- Both outputs are marginable and trimmable via the PMBus interface.
 - Programmable: UVLO, Soft Start, and Enable via the PMBus interface
 - Programmable overcurrent warning and fault limits and programmable response to faults via the PMBus interface
 - Programmable overvoltage warning and fault limit and programmable response to faults via the PMBus interface
 - Programmable high- and low-output margin voltages with a maximum range of +10%, –20% of nominal output voltage
- Convenient test points for probing critical waveforms

2 Electrical Performance Specifications

Table 1. PWR091EVM-001 Electrical Performance Specifications

PARAMETER	TEST CONDITIONS	MIN	TYP	MAX	UNITS
INPUT CHARACTERISTICS					
Voltage range	V_{IN}	8	12	14	V
Maximum input current	$V_{IN} = 8\text{ V}$, $I_{O1} = 20\text{ A}$, $I_{O2} = 15\text{ A}$		10	15	A
No load input current	$V_{IN} = 14\text{ V}$, $I_{O1} = 0\text{ A}$, $I_{O2} = 0\text{ A}$		100		mA
OUTPUT CHARACTERISTICS					
V_{OUT1} Output voltage	Output current = 10 A		1.2		V
V_{OUT2} Output voltage	Output current = 10 A		3.3		V
I_{OUT1} Output load current	I_{OUT_min} to I_{OUT_max}	0		20	A
I_{OUT2} Output load current	I_{OUT_min} to I_{OUT_max}	0		15	A
Output voltage regulation	Line regulation: Input voltage = 8 V to 14 V		0.5%		
	Load regulation: Output current = 0 A to I_{OUT_max} , both outputs		0.5%		
V_{OUT1} Output voltage ripple	$V_{IN} = 12\text{ V}$, $I_{OUT} = 20\text{ A}$		30		mVpp
V_{OUT2} Output voltage ripple	$V_{IN} = 12\text{ V}$, $I_{OUT} = 15\text{ A}$		30		mVpp
V_{OUT1} Output overcurrent			25		A
V_{OUT2} Output overcurrent			20		A
SYSTEMS CHARACTERISTICS					
Switching frequency	F_{SW}		460		kHz
V_{OUT1} Peak efficiency	$V_{IN} = 8\text{ V}$, $I_{O1} = 10\text{ A}$, V_{OUT2} disabled, $F_{SW} = 300\text{ kHz}$		92%		
V_{OUT2} Peak efficiency	$V_{IN} = 8\text{ V}$, $I_{O2} = 8.5\text{ A}$, V_{OUT1} disabled, $F_{SW} = 300\text{ kHz}$		95%		
V_{OUT1} Full-load efficiency	$V_{IN} = 8\text{ V}$, $I_{O1} = 10\text{ A}$, V_{OUT2} disabled, $F_{SW} = 300\text{ kHz}$		90%		
V_{OUT2} Full-load efficiency	$V_{IN} = 8\text{ V}$, $I_{O2} = 8.5\text{ A}$, V_{OUT1} disabled, $F_{SW} = 300\text{ kHz}$		93%		
Operating temperature	T_{oper}		25		°C

3 Schematic

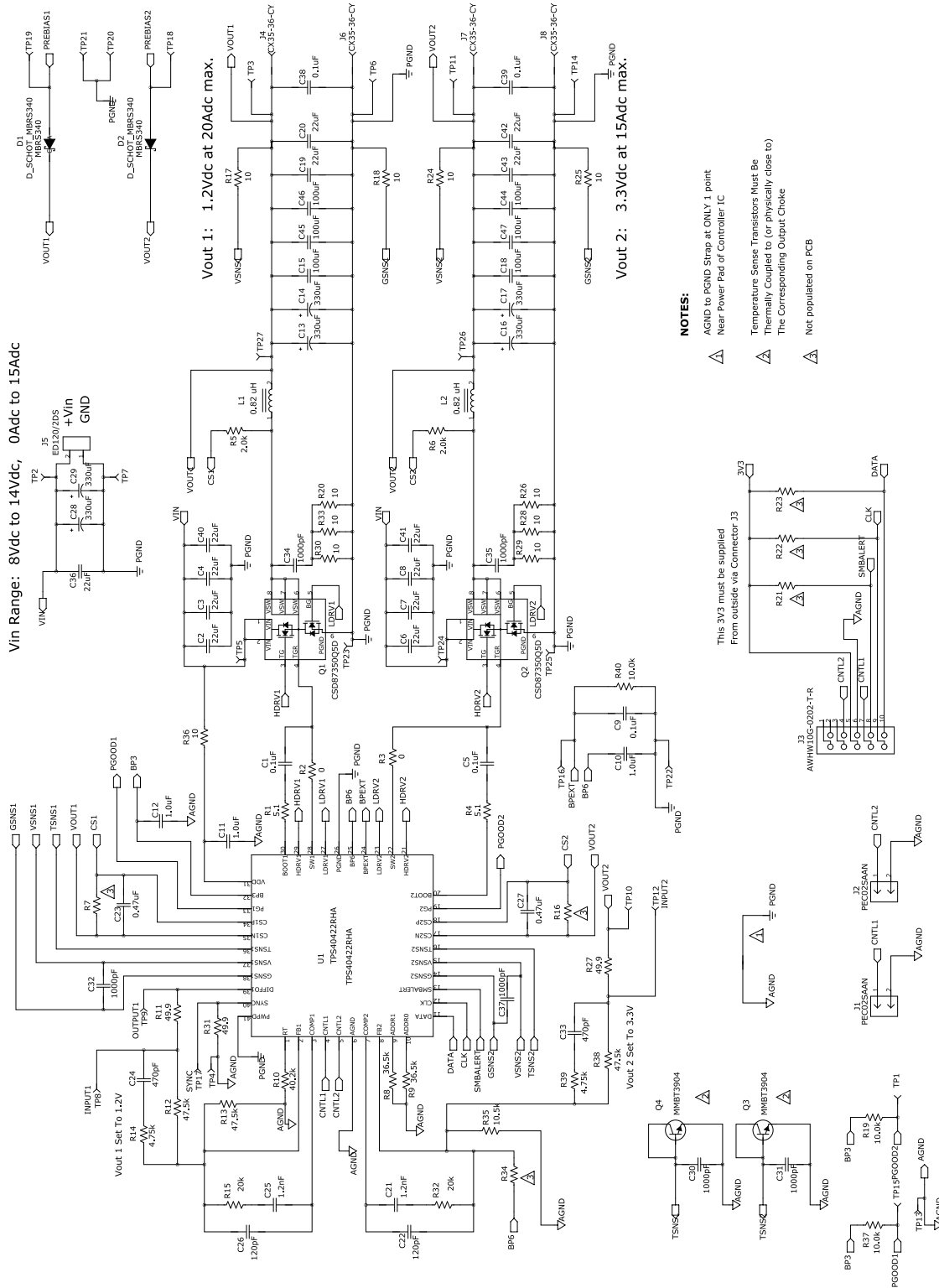

Figure 1. PWR091EVM Schematic

4 Test Setup

4.1 Test and Configuration Software

To change any of the default configuration parameters on the EVM, it is necessary to obtain the TI Fusion Digital Power Designer software.

4.1.1 Description

The Fusion Digital Power Designer is the graphical user interface (GUI) used to configure and monitor the Texas Instruments TPS40422 power controller on this evaluation module. The application uses the PMBus protocol to communicate with the controller over serial bus by way of a TI USB adapter (see [Figure 3](#)).

4.1.2 Features

Some of the tasks you can perform with the GUI include:

- Turn on or off the power supply output, either through the hardware control line or the PMBus operation command.
- Monitor real-time data. Items such as input voltage, output voltage, output current, temperature, and warnings and faults are continuously monitored and displayed by the GUI.
- Configure common operating characteristics such as VOUT trim and margin, UVLO, soft-start time, warning and fault thresholds, fault response, and ON/OFF.

This software is available for download at http://www.ti.com/tool/fusion_digital_power_designer

4.2 Test Equipment

Voltage Source: The input voltage source VIN must be a 0-V to 14-V variable dc source capable of supplying 15 Adc. Connect VIN to J5 as shown in [Figure 2](#).

Multimeters: It is recommended to use three separate multimeters as shown in [Figure 2](#). One meter to measure Vin, one to measure Vout1 and the third to measure Vout2.

Output Load: Two variable electronic loads are recommended for the test setup as shown in [Figure 2](#). Load 1 must be capable of 25 A at voltages as low as 0.9 V. Load 2 must be capable of 20 A at voltages as low as 3 V.

Oscilloscope: An oscilloscope is recommended for measuring output noise and ripple. Output ripple must be measured using a Tip-and-Barrel method or better as shown in [Figure 4](#). The scope must be adjusted to 20-MHz bandwidth, ac coupling at 50 mV/division, and must be set to 1-μs/division.

Fan: During prolonged operation at high loads, it may be necessary to provide forced air cooling with a small fan aimed at the EVM. The temperature of the devices on the EVM must be maintained at less than 105°C.

USB-to-GPIO Interface Adapter: A communications adapter is required between the EVM and the host computer. This EVM was designed to use the Texas Instruments USB-to-GPIO Adapter (see [Figure 3](#)). This adapter can be purchased at <http://www.ti.com/tool/usb-to-gpio>.

Recommended Wire Gauge: It is recommended that the voltage drop in the load wires does not exceed 0.2 V total in order to keep the voltage at the load above 1 V. See the following table for recommended wire gauge and length to achieve a voltage drop of no more than 0.2 V at a 20-A load.

AWG Gauge	Ohms per Foot (Ω)	Load Wires Combined Length (Ft)	Each Wire Length (Ft)
12	1.59E-3	6.30	3.15
14	2.53E-3	3.96	1.98
16	4.02E-3	2.49	1.25
18	6.39E-3	1.57	0.78

As an example, if AWG 12 wire is used, no more than 3.15 feet of wire must be used between the EVM and the load.

4.3 Recommended Test Setup

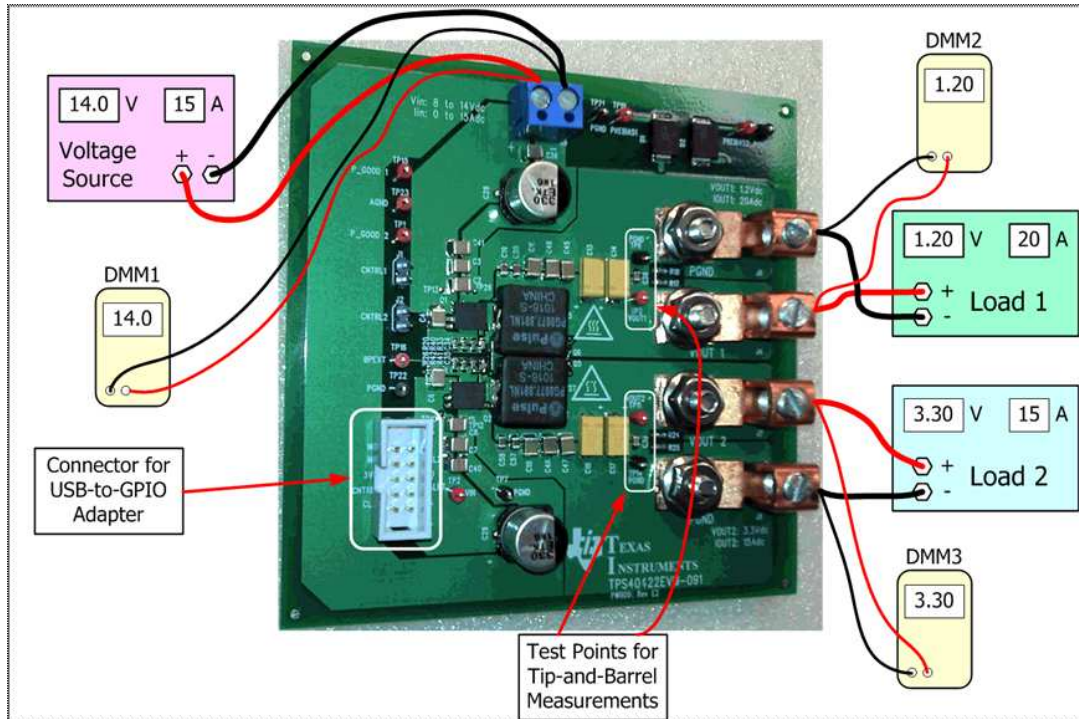

Figure 2. PWR091EVM Recommended Test Setup

4.4 USB Interface Adapter and Cable

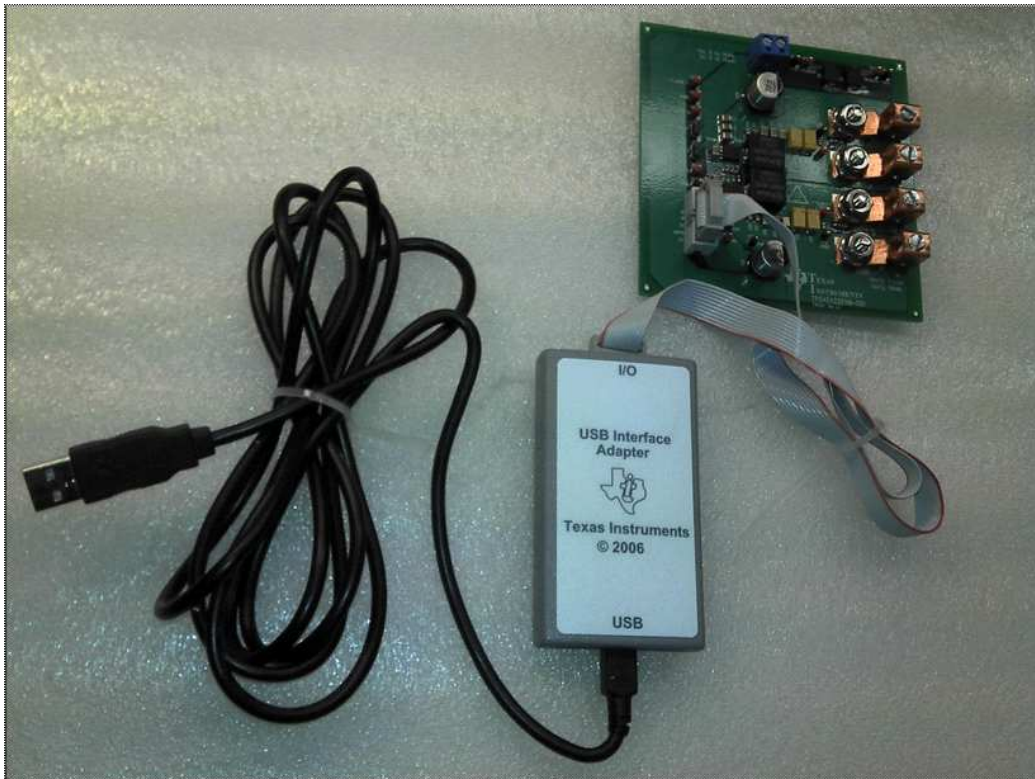

Figure 3. Texas Instruments USB-to-GPIO Adapter and Connections

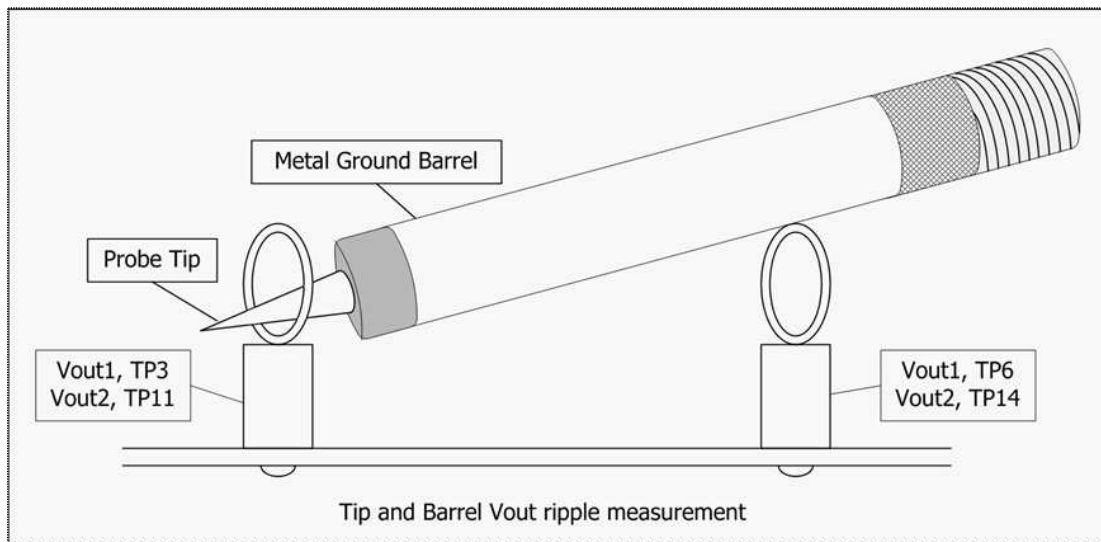

Figure 4. Tip and Barrel Measurement

4.5 List of Test Points

Table 2. The Functions of Each Test Points

Test Point	Type	Name	Description
TP1	T-H Loop	PGOOD2	Power Good signal for Vout 2.
TP2	T-H Loop	VIN	General input voltage measurement.
TP3	T-H Loop	VOUT1	Tip and barrel point for Vout 1.
TP6	T-H Loop	PGND	Tip and barrel point for Vout 1 return.
TP7	T-H Loop	PGND	General input voltage measurement.
TP11	T-H Loop	VOUT2	Tip and barrel point for Vout 2.
TP13	T-H Loop	AGND	Return for PGOOD signals.
TP14	T-H Loop	PGND	Tip and barrel point for Vout 2 return.
TP15	T-H Loop	PGOOD1	Power Good signal for Vout 1.
TP16	T-H Loop	BPEXT	Point to inject BP External.
TP18	T-H Loop	PREBIAS2	Point to inject Prebias for output 2.
TP19	T-H Loop	PREBIAS1	Point to inject Prebias for output 1.
TP20	T-H Loop	PGND	Return for Prebias 2.
TP21	T-H Loop	PGND	Return for Prebias 1.
TP22	T-H Loop	PGND	Return for BP External.
TP4	SMT	AGND	Return for SYNC signal.
TP8	SMT	INPUT1	Input for control loop measurements for Vout 1.
TP9	SMT	OUTPUT1	Output of Vout 1 for control loop measurements.
TP10	SMT	VOUT2	Output of Vout 2 for control loop measurements.
TP12	SMT	INPUT2	Input for control loop measurements for Vout 2.
TP17	SMT	SYNC	Point to inject SYNC signal.
TP5	Copper Dot	VIN	Vin+ measurement point for efficiency of Vout 1.
TP23	Copper Dot	PGND	Vin- measurement point for efficiency of Vout 1.
TP24	Copper Dot	VIN	Vin+ measurement point for efficiency of Vout 2.
TP25	Copper Dot	PGND	Vin- measurement point for efficiency of Vout 2.
TP26	Copper Dot	VOUT2	Vout+ measurement point for efficiency of Vout 2.
TP27	Copper Dot	VOUT1	Vout+ measurement point for efficiency of Vout 1.

5 EVM Configuration Using the Fusion GUI

The TPS40422 on this EVM leaves the factory pre-configured. See [Table 3](#) for a short list of key factory configuration parameters as obtained from the configuration file.

Table 3. Key Factory Configuration Parameters

Address Hex	Address Dec	Part ID			
0x1B	27	TPS40422			
General					
Cmd ID With Phase	Cmd Code Hex	Encoded Hex	Decoded	Numeric	Comments
VIN_OFF	0x36	0xF014	5.00 V	5	Turn OFF voltage
VIN_ON	0x35	0xF01C	7.00 V	7	Turn ON voltage
Vout 1					
					Comments
IOUT_CAL_GAIN	0x38	0x8821	1.0071 mΩ	1.0071	DCR of output inductor
IOUT_CAL_OFFSET	0x39	0xE000	0.0000 A	0	Current offset for GUI readout
IOUT_OC_FAULT_LIMIT	0x46	0xF83C	30.0 A	30	OC fault level
IOUT_OC_FAULT_RESPONSE	0x47	0x3C	Restart Continuously		Response to OC fault
IOUT_OC_WARN_LIMIT	0x4A	0xF832	25.0 A	25	OC warning level
MFR_04 (VREF_TRIM)	0xD4	0x0000	0.000 V	0	Trim voltage
ON_OFF_CONFIG	0x02	0x02	Mode: Always Converting		Control signal and OPERATION command not required
OPERATION	0x01	0x00	Unit: Immediate Off; Margin: None		Response to turn OFF trigger
OT_FAULT_LIMIT	0x4F	0x007D	125 C	125	OT fault level
OT_WARN_LIMIT	0x51	0x0064	100 C	100	OT warn level
TON_RISE	0x61	0xE02B	2.6875 ms	2.6875	Soft-start time
Vout 2					
					Comments
IOUT_CAL_GAIN	0x38	0x8821	1.0071 mΩ	1.0071	DCR of output inductor
IOUT_CAL_OFFSET	0x39	0xE000	0.0000 A	0	Current offset for GUI readout
IOUT_OC_FAULT_LIMIT	0x46	0xF832	25.0 A	25	OC fault level
IOUT_OC_FAULT_RESPONSE	0x47	0x3C	Restart Continuously		Response to OC fault
IOUT_OC_WARN_LIMIT	0x4A	0xF828	20.0 A	20	OC warning level
MFR_04 (VREF_TRIM)	0xD4	0x0000	0.000 V	0	Trim voltage
ON_OFF_CONFIG	0x02	0x02	Mode: Always Converting		Control signal and OPERATION command not required
OPERATION	0x01	0x00	Unit: Immediate Off; Margin: None		Response to turn OFF trigger
OT_FAULT_LIMIT	0x4F	0x007D	125 C	125	OT fault level
OT_WARN_LIMIT	0x51	0x0064	100 C	100	OT warn level
TON_RISE	0x61	0xE02B	2.6875 ms	2.6875	Soft-start time

If it is desired to configure the EVM to settings other than the factory settings shown in [Table 3](#), the TI Fusion Digital Power Designer software can be used for reconfiguration. It is necessary to have input voltage applied to the EVM prior to launching the software so that the TPS40422 may respond to the GUI and the GUI can recognize the TPS40422. The default configuration for the EVM is to start converting at an input voltage of 7 V; therefore, to avoid any converter activity during configuration, an input voltage less than 7 V must be applied. An input voltage of 5 V is recommended.

5.1 Configuration Procedure

1. Adjust the input supply to provide 5 Vdc, current limited to 1 A.
2. Apply the input voltage to the EVM. See [Figure 2](#) and [Figure 3](#) for connections and test setup.
3. Launch the Fusion GUI software. See the screen shots in [Section 10](#) for more information.
4. Configure the EVM operating parameters as desired.

NOTE: The *IOUT_CAL_GAIN* parameter is used by the TPS40422 in the calculation of output current level, and this number is the dc resistance of the output inductor. Although this number can be reconfigured, a number entry that does not match the actual DCR of the inductor on the EVM will result in current reporting inaccuracy. This also affects OC Fault and OC Warn performance.

The *TON_RISE* parameter may affect proper start-up if the rise time and output capacitance bank result in a current that exceeds the OC Fault level. The start-up surge current in the output capacitance bank is added to the load current, so the sum of these two currents must be less than the OC Fault level for proper start-up.

6 Test Procedure

6.1 Line/Load Regulation and Efficiency Measurement Procedure

1. Set up the EVM as described in [Section 4.3](#) and [Figure 2](#).
2. Ensure that both electronic loads are set to draw 0 Adc.
3. Increase V_{in} from 0 V to 12 V using DMM1 to measure input voltage.
4. Use DMM2 to measure output voltage V_{out1} .
5. Vary the load from 0 Adc to 20 Adc. V_{out1} must remain in regulation as defined in [Table 1](#).
6. Vary V_{in} from 8 V to 14 V. V_{out1} must remain in regulation as defined in [Table 1](#).
7. Decrease the load to 0 A.
8. Use DMM3 to measure output voltage V_{out2} .
9. Vary the load from 0 Adc to 15 Adc. V_{out1} must remain in regulation as defined in [Table 1](#).
10. Vary V_{in} from 8 V to 14 V. V_{out2} must remain in regulation as defined in [Table 1](#).
11. Decrease the load to 0 A.
12. Decrease V_{in} to 0 V.

6.2 Control Loop Gain and Phase Measurement Procedure

The PWR091EVM includes a 49.9- Ω series resistor in the feedback loop for both V_{out1} and V_{out2} . These resistors are used for loop response analysis and are accessible at the test points TP8 and TP9 for V_{out1} , and TP10 and TP12 for V_{out2} . Those test points must be used during loop response measurements as the injection points for the loop perturbation. See the short descriptions listed in [Table 4](#).

Table 4. List of Test Points for Loop Response Measurements

Test Point	Node Name	Description	Comment
TP8	INPUT1	Input to feedback divider of V_{out1}	The amplitude of the perturbation at this node must be limited to less than 100 mV.
TP9	OUTPUT1	Resulting output of V_{out1}	Bode plot data can be measured by a network analyzer as TP9/TP8.
TP12	INPUT2	Input to feedback divider of V_{out2}	The amplitude of the perturbation at this node must be limited to less than 100mV.
TP10	VOU2	Resulting output of V_{out2}	Bode plot data can be measured by a network analyzer as TP10/TP12.

Measure only one output at a time with the following procedure:

1. Set up the EVM as described in [Section 4.3](#) and [Figure 2](#).
2. For V_{out1} , connect the network analyzer's isolation transformer from TP8 to TP9.
3. Connect the input signal measurement probe to TP8. Connect output signal measurement probe to TP9.
4. Connect the ground leads of both probe channels to TP4.
5. On the network analyzer, measure the Bode plot data as TP9/TP8 (Out/In). The frequency sweep must

- be limited to less than the switching frequency divided by 2 ($F_{sw}/2$).
6. For Vout2, connect the network analyzer's isolation transformer from TP12 to TP10.
 7. Connect the input signal measurement probe to TP12. Connect output signal measurement probe to TP10.
 8. Connect the ground leads of both probe channels to TP4.
 9. On the network analyzer, measure the Bode plot data as TP10/TP12 (Out/In). The frequency sweep must be limited to less than the switching frequency divided by 2 ($F_{sw}/2$).
 10. Disconnect the isolation transformer from the Bode plot test points before making other measurements, because the signal injection into the feedback loop may interfere with the accuracy of other measurements.

6.3 Efficiency

To measure the efficiency of the power train on the EVM, it is important to measure the voltages at the correct location. This is necessary because otherwise the measurements will include losses in efficiency that are not related to the power train itself. Losses incurred by the voltage drop in the copper traces and in the input and output connectors are not related to the efficiency of the power train, and they must not be included in efficiency measurements.

When measuring the efficiency of Vout1, Vout2 must be disabled by the user via the Fusion GUI. Likewise, when measuring the efficiency of Vout2, Vout1 must be disabled by the user. See the list in [Table 5](#) for the proper locations to measure efficiency.

Table 5. List of Test Points for Efficiency Measurements

Test Point	Node Name	Description	Comment
TP5	VIN	Measurement point for VIN +VE	Copper dot at high-side FET drain
TP23	PGND	Measurement point for VIN –VE	Copper dot at low-side FET source
TP27	VOUT1	Measurement point for VOUT1 +VE	Copper dot at output inductor, dc side
TP23	PGND	Measurement point for VOUT1 –VE	Copper dot at low-side FET source
TP24	VIN	Measurement point for VIN +VE	Copper dot at high-side FET drain
TP25	PGND	Measurement point for VIN –VE	Copper dot at low-side FET source
TP26	VOUT2	Measurement point for VOUT2 +VE	Copper dot at output inductor, dc side
TP25	PGND	Measurement point for VOUT2 –VE	Copper dot at low-side FET source

Input current can be measured at any point in the input wires, and output current can be measured anywhere in the output wires of the output being measured. Using these measurement points result in efficiency measurements that do not include losses due to the connectors and PCB traces.

6.4 Equipment Shutdown

1. Reduce the load current on both outputs to 0 A.
2. Reduce input voltage to 0 V.
3. Shut down the external fan if in use.
4. Shut down equipment.

7 Performance Data and Typical Characteristic Curves

[Figure 5](#) through [Figure 25](#) present typical performance curves for the PWR091EVM.

7.1 Efficiency

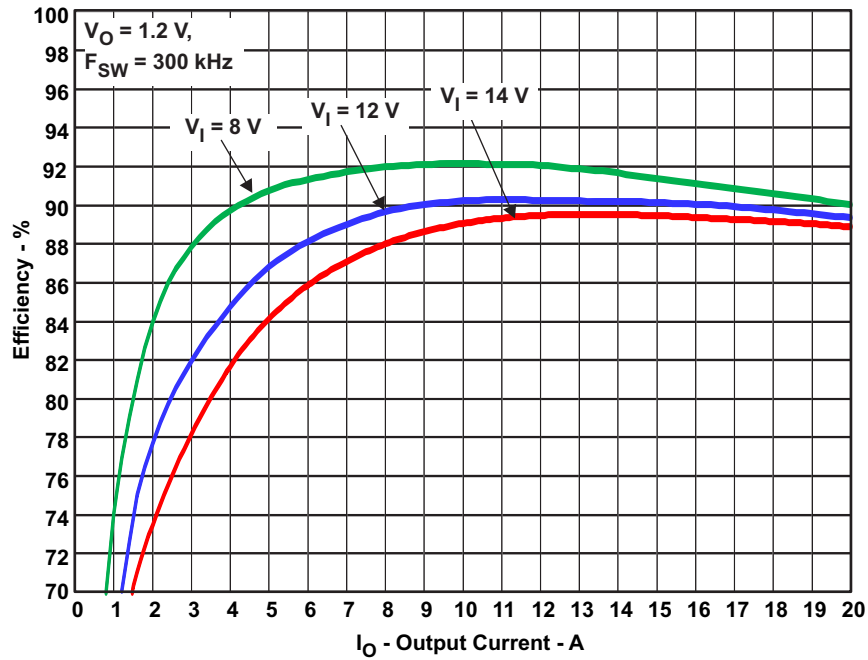

Figure 5. Efficiency of 1.2-V Output vs Line and Load

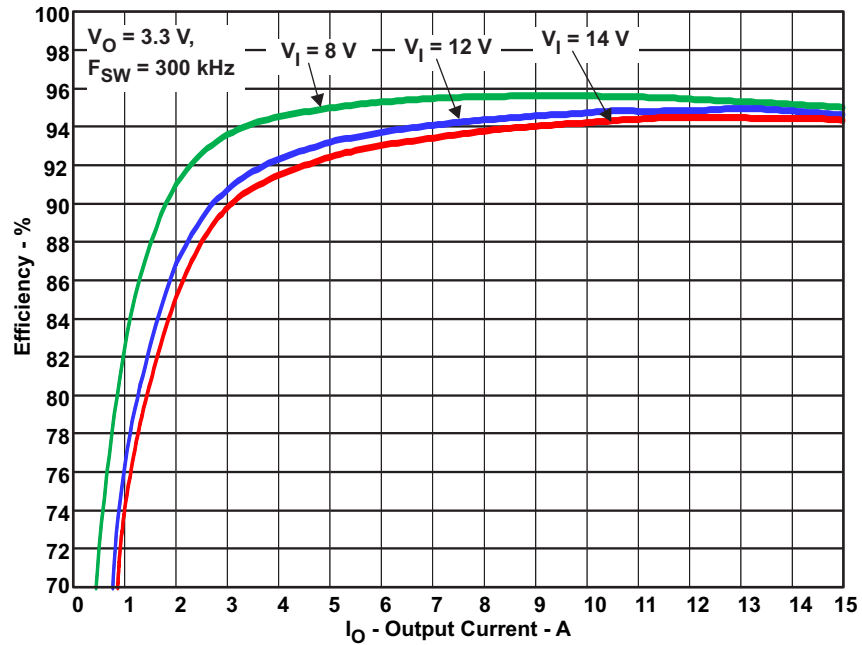

Figure 6. Efficiency of 3.3-V Output vs Line and Load

7.2 Load Regulation

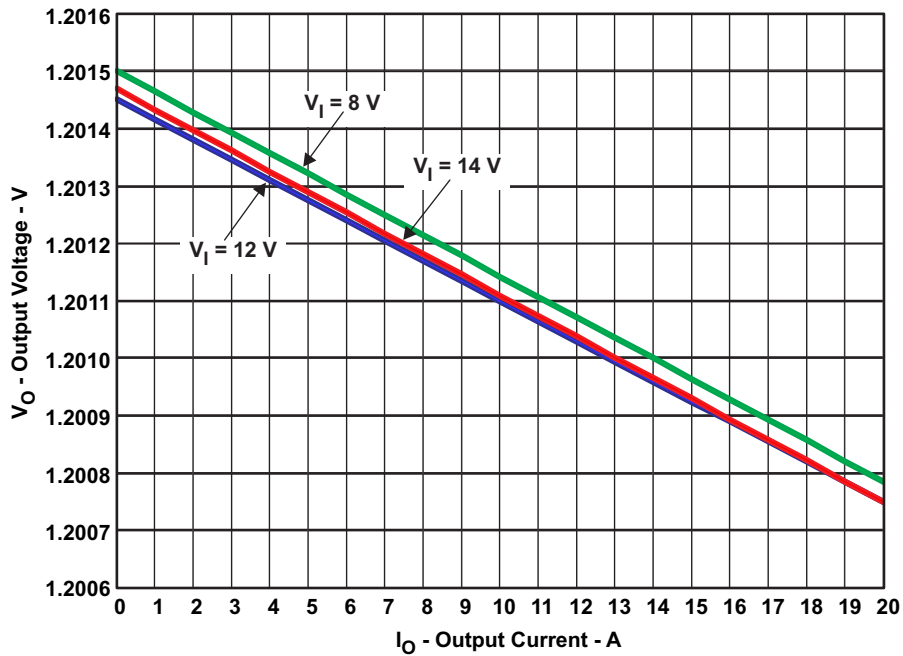

Figure 7. Load Regulation of 1.2-V Output

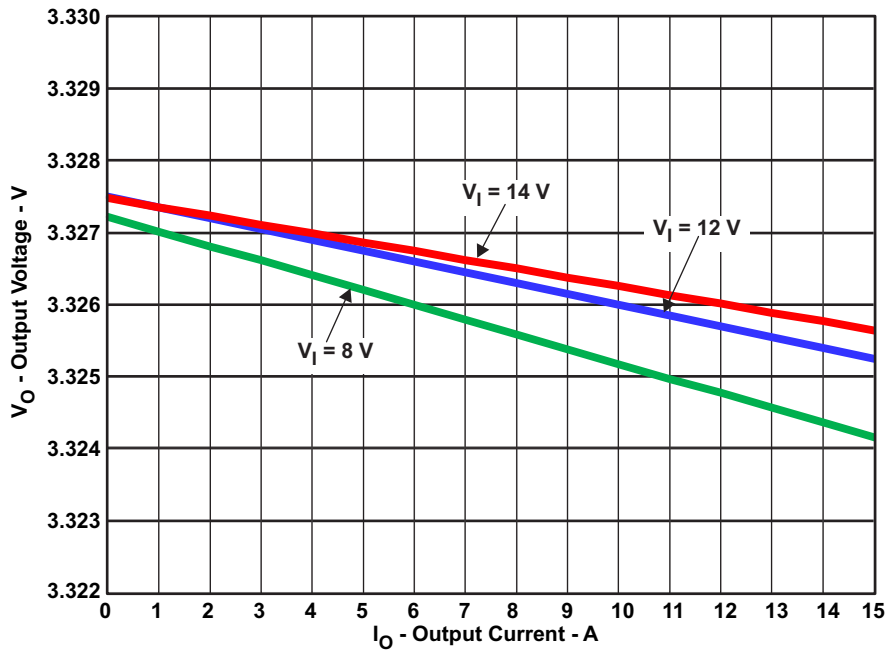

Figure 8. Load Regulation of 3.3-V Output

7.3 Bode Plot

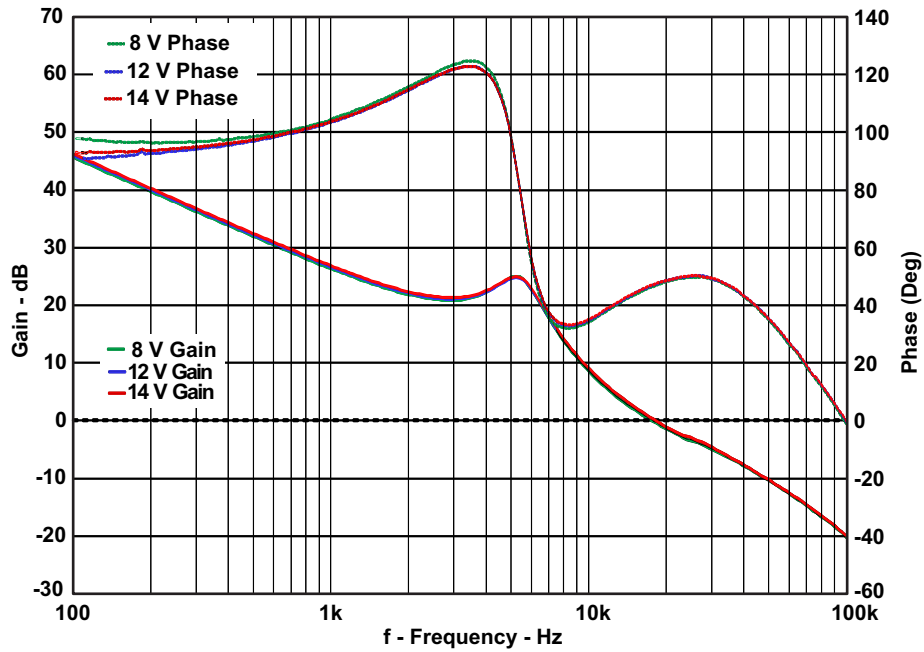

Figure 9. Bode Plot of 1.2-V Output at 10-A Load

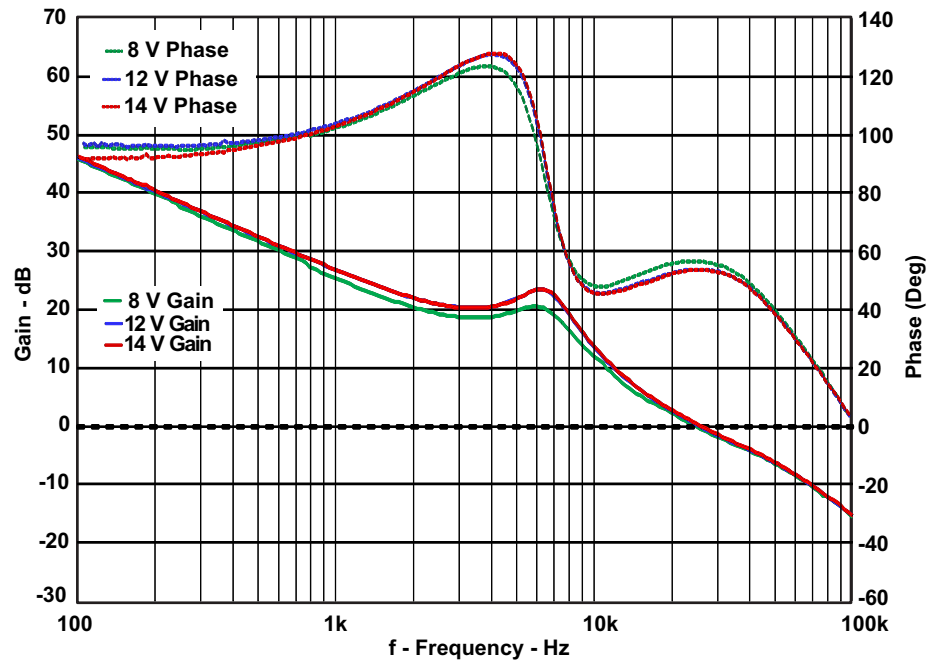
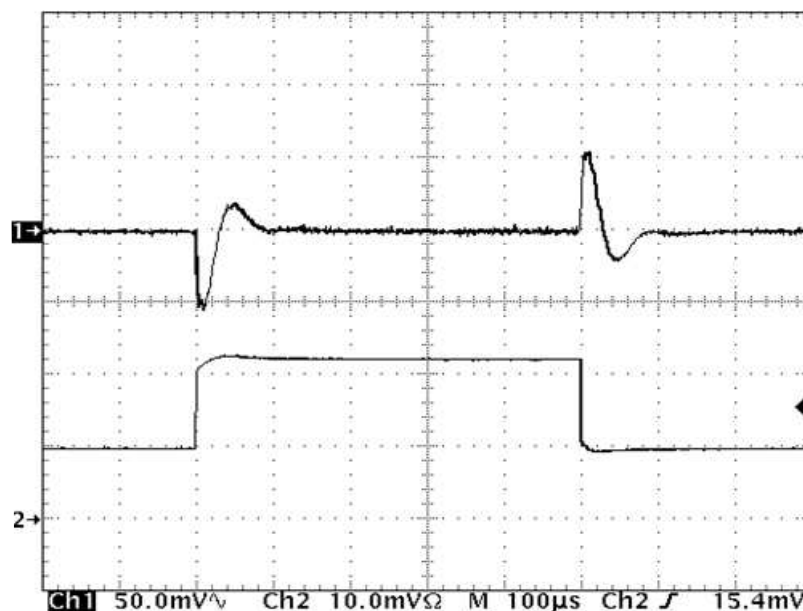

Figure 10. Bode Plot of 3.3-V Output at 10-A Load

7.4 Transient Response



Ch1 = Vout1 at 50mV/division, Ch2 = Iout1 at 5A/division

Figure 11. Transient Response of 1.2-V Output at 8 Vin, Transient is 5 A to 11 A to 5 A

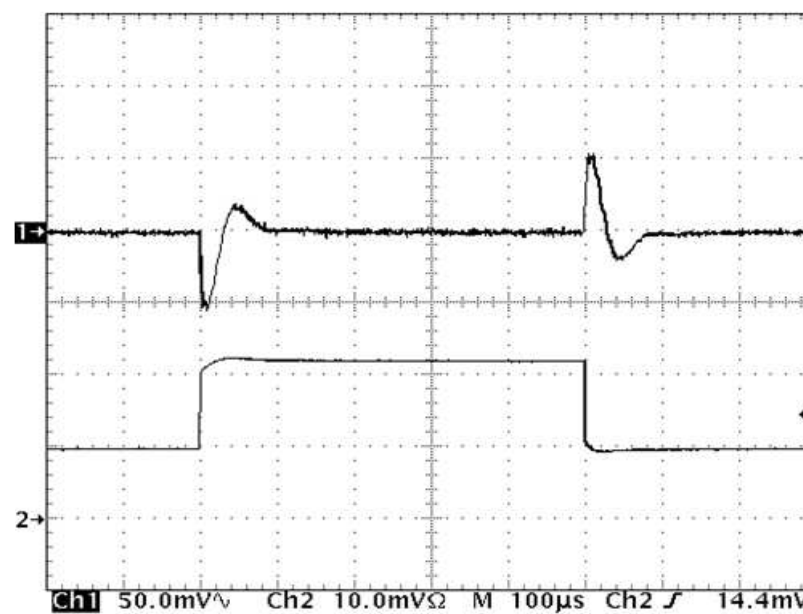

Ch1 = Vout1 at 50mV/division, Ch2 = Iout1 at 5A/division

Figure 12. Transient Response of 1.2-V Output at 12 Vin, Transient is 5 A to 11 A to 5 A

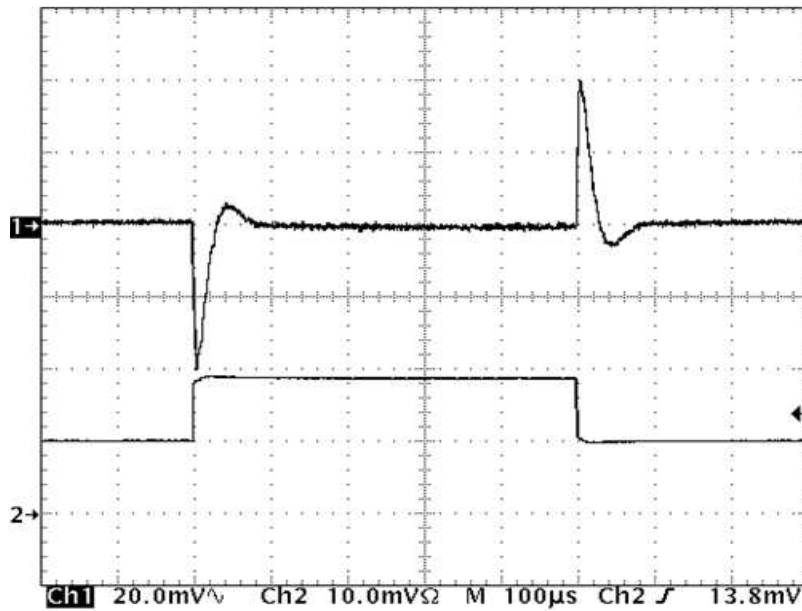

Ch1 = Vout2 at 20mV/division, Ch2 = Iout2 at 5A/division

Figure 13. Transient Response of 3.3-V Output at 8 Vin, Transient is 5 A to 9 A to 5 A

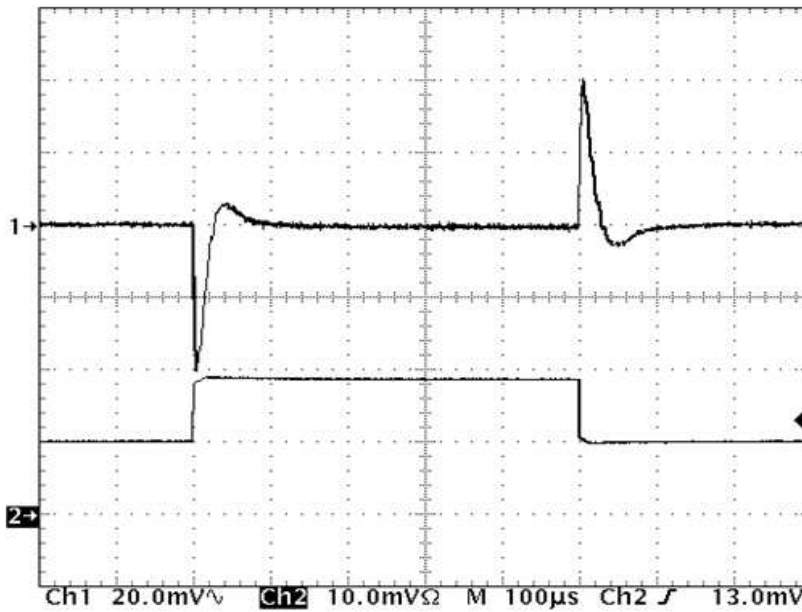

Ch1 = Vout2 at 20mV/division, Ch2 = Iout2 at 5A/division

Figure 14. Transient Response of 3.3-V Output at 12 Vin, Transient is 5 A to 9 A to 5 A

7.5 Output Ripple

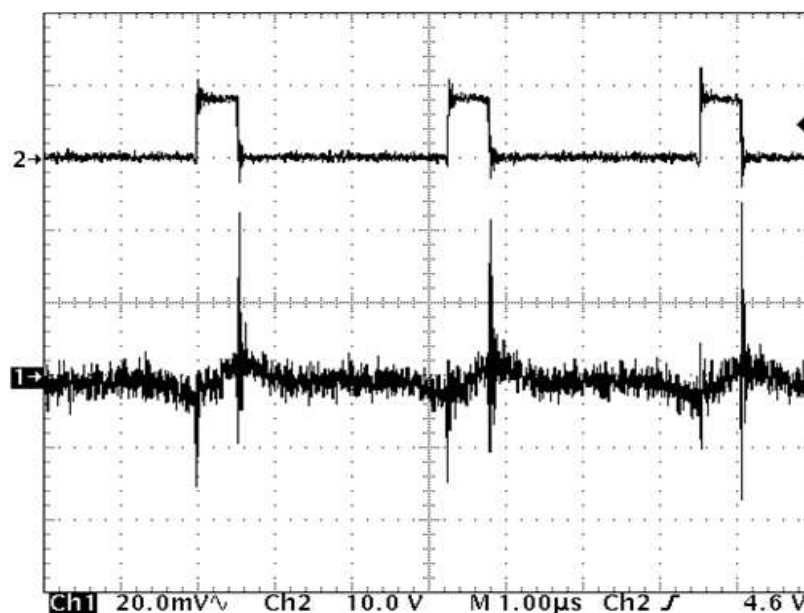

Ch1 = Vout1 at 20mV/division, Ch2 = SW Node at 10V/division

Figure 15. Output Ripple and SW Node of 1.2-V Output at 8 Vin, 20-A Output

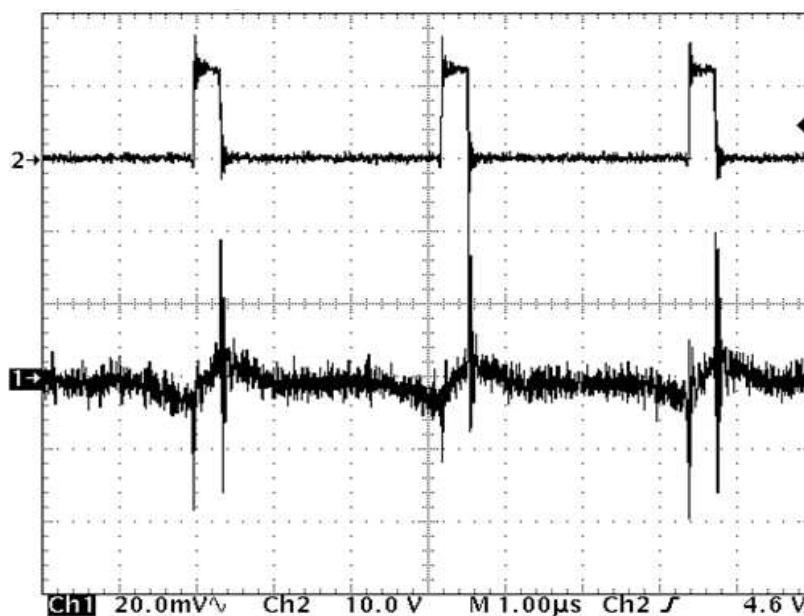

Ch1 = Vout1 at 20mV/division, Ch2 = SW Node at 10V/division

Figure 16. Output Ripple and SW Node of 1.2-V Output at 12 Vin, 20-A Output

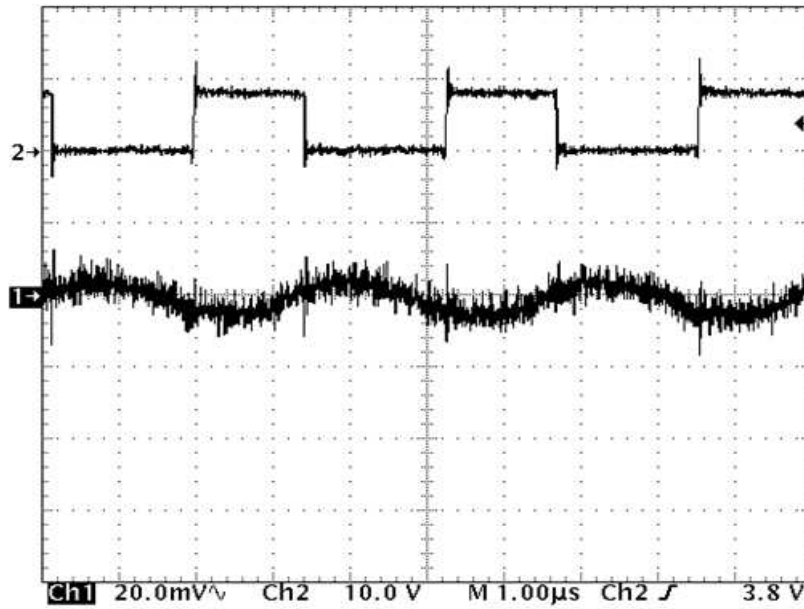

Ch1 = Vout2 at 20mV/division, Ch2 = SW Node at 10V/division

Figure 17. Output Ripple and SW Node of 3.3-V Output at 8 Vin, 15-A Output

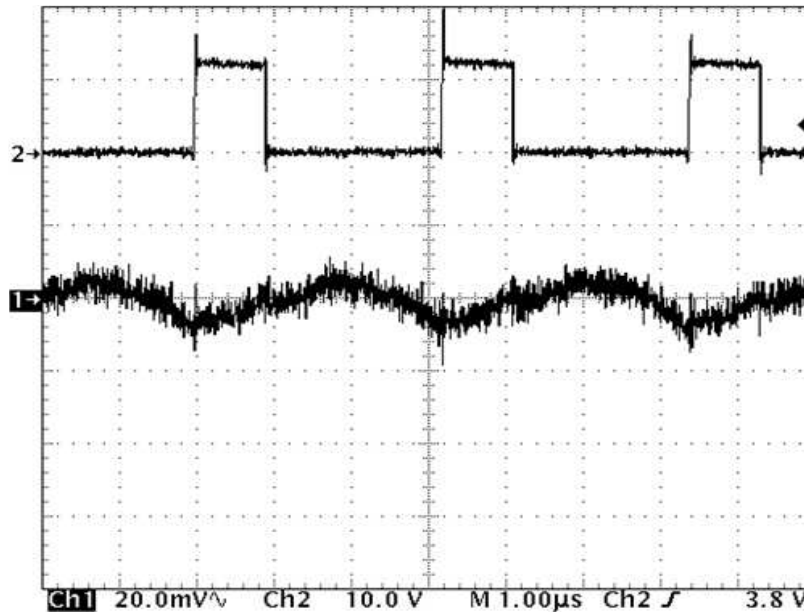

Ch1 = Vout2 at 20mV/division, Ch2 = SW Node at 10V/division

Figure 18. Output Ripple and SW Node of 3.3-V Output at 12 Vin, 15-A Output

7.6 HDRV and Switch Node Voltage

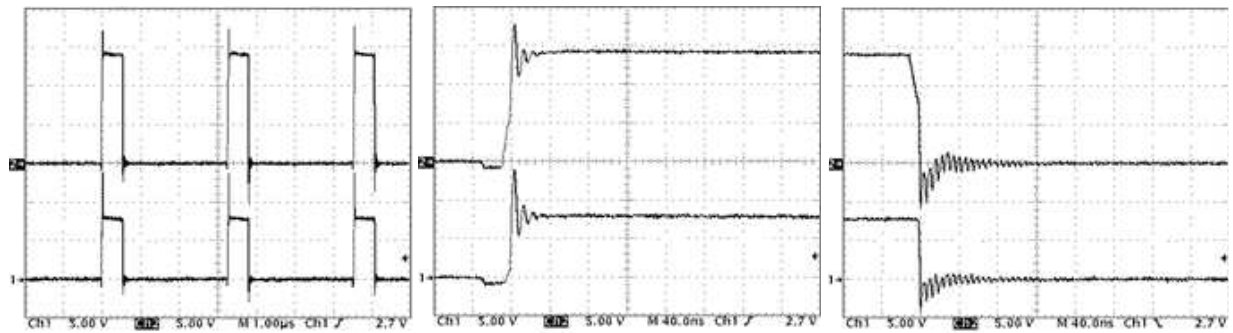

Ch1 = SW Node at 5 V/division, Ch2 = HDRV at 5 V/division

Figure 19. HDRV and SW Node of 1.2-V Output at 8 Vin, 20-A Output

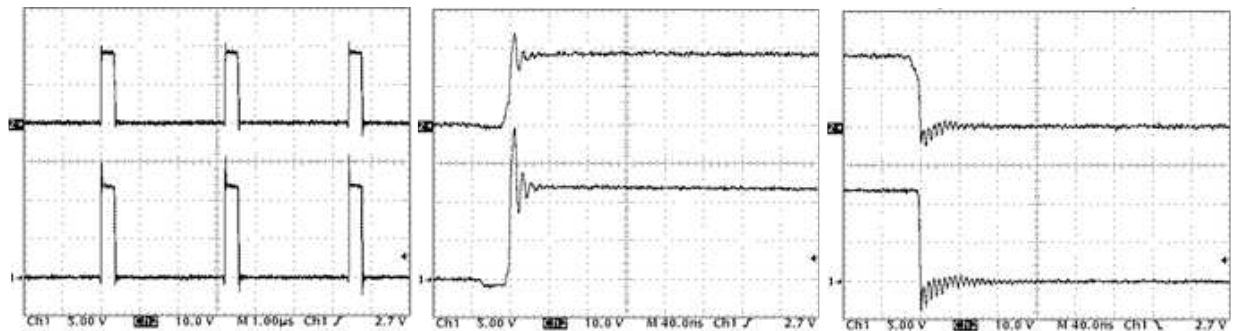

Ch1 = SW Node at 5 V/division, Ch2 = HDRV at 10 V/division

Figure 20. HDRV and SW Node of 1.2-V Output at 12 Vin, 20-A Output

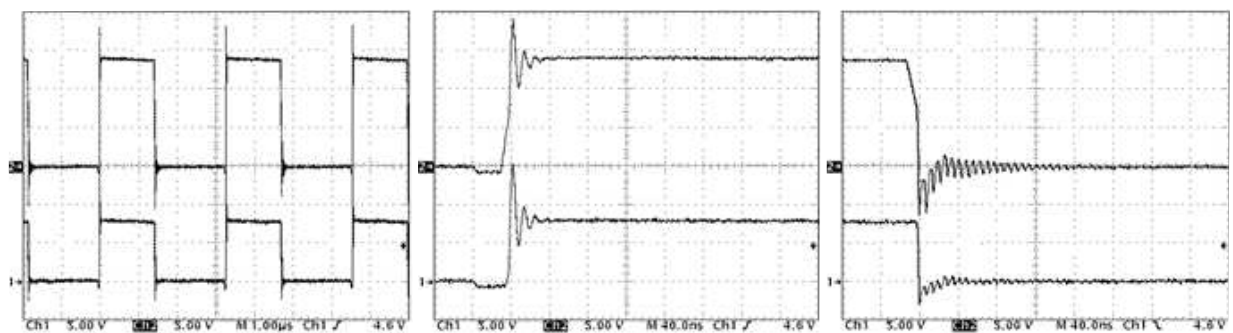

Ch1 = SW Node at 5 V/division, Ch2 = HDRV at 5 V/division

Figure 21. HDRV and SW Node of 3.3-V Output at 8-Vin, 15-A Output

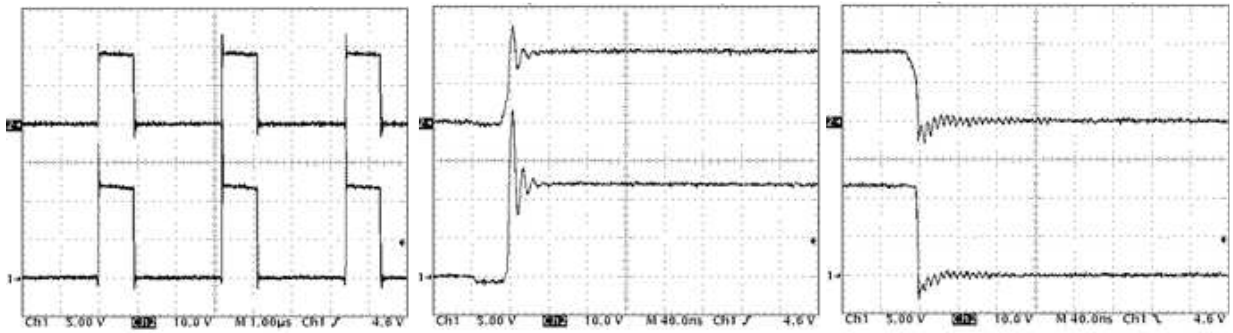

Ch1 = SW Node at 5 V/division, Ch2 = HDRV at 10 V/division

Figure 22. HDRV and SW Node of 3.3-V Output at 12 Vin, 15-A Output

7.7 Turnon Waveform

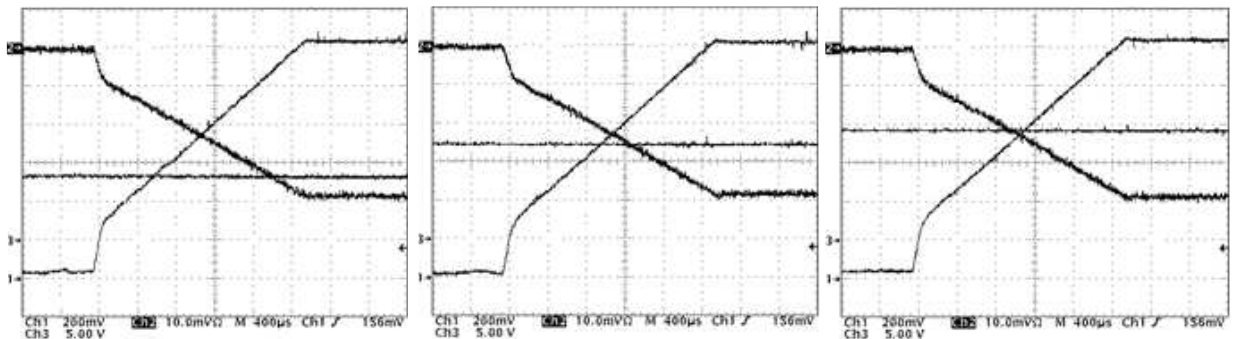

Ch1 = Vout1 at 200 mV/division, Ch2 = Iout1 at 5 A/division, Ch3 = Vin at 5 V/division Ch2 (Iout) Inverted to better display V and I.

Figure 23. Turnon Waveform of 1.2-V Output at 8-V, 12-V and 14-V Input, 20-A Output

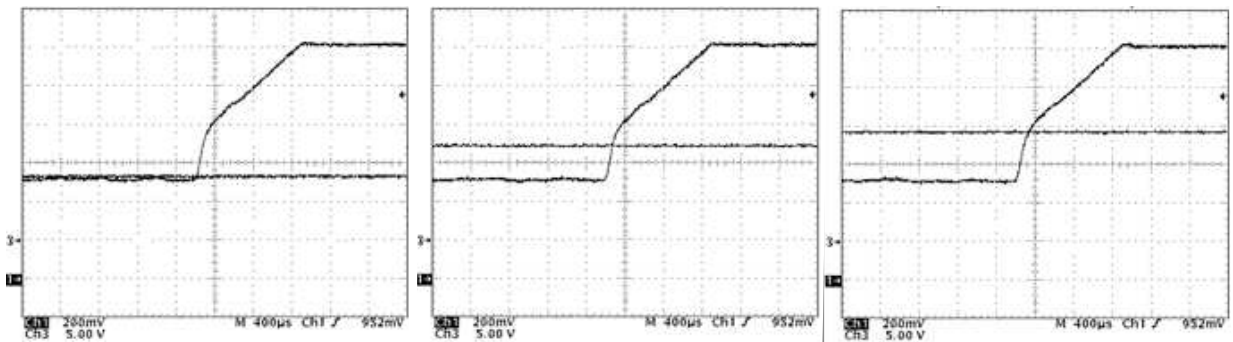

Ch1 = Vout1 at 200 mV/division, Ch3 = Vin at 5 V/division

Figure 24. Turnon Waveform of 1.2-V Output With 0.5-V Prebias, at 8-V, 12-V and 14-V Input, 0-A Output

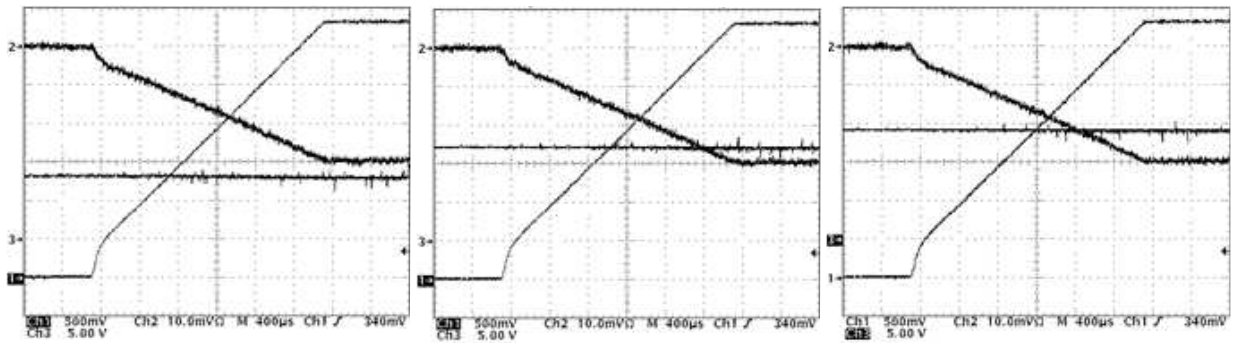

Ch1 = Vout2 at 500 mV/division, Ch2 = Iout2 at 5 A/division, Ch3 = Vin at 5 V/division Ch2 (Iout) Inverted to better display V and I.

Figure 25. Turnon Waveform of 3.3-V Output at 8-V, 12-V, and 14-V Input, 15-A Output

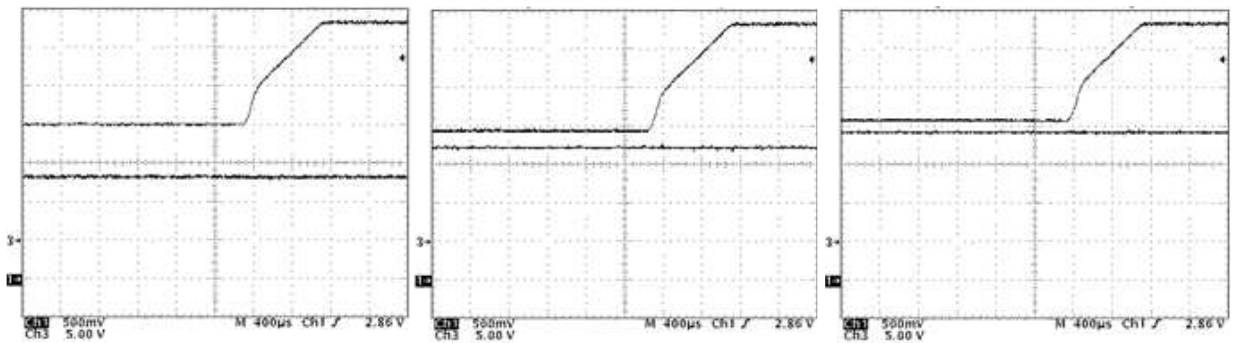

Ch1 = Vout1 at 500 mV/division, Ch3 = Vin at 5 V/division

Figure 26. Turnon Waveform of 3.3-V Output With 2-V Prebias, at 8-V, 12-V, and 14-V Input, 0-A Output

8 EVM Assembly Drawing and PCB Layout

Figure 27 through Figure 32 show the design of the PWR091EVM printed-circuit board (PCB).

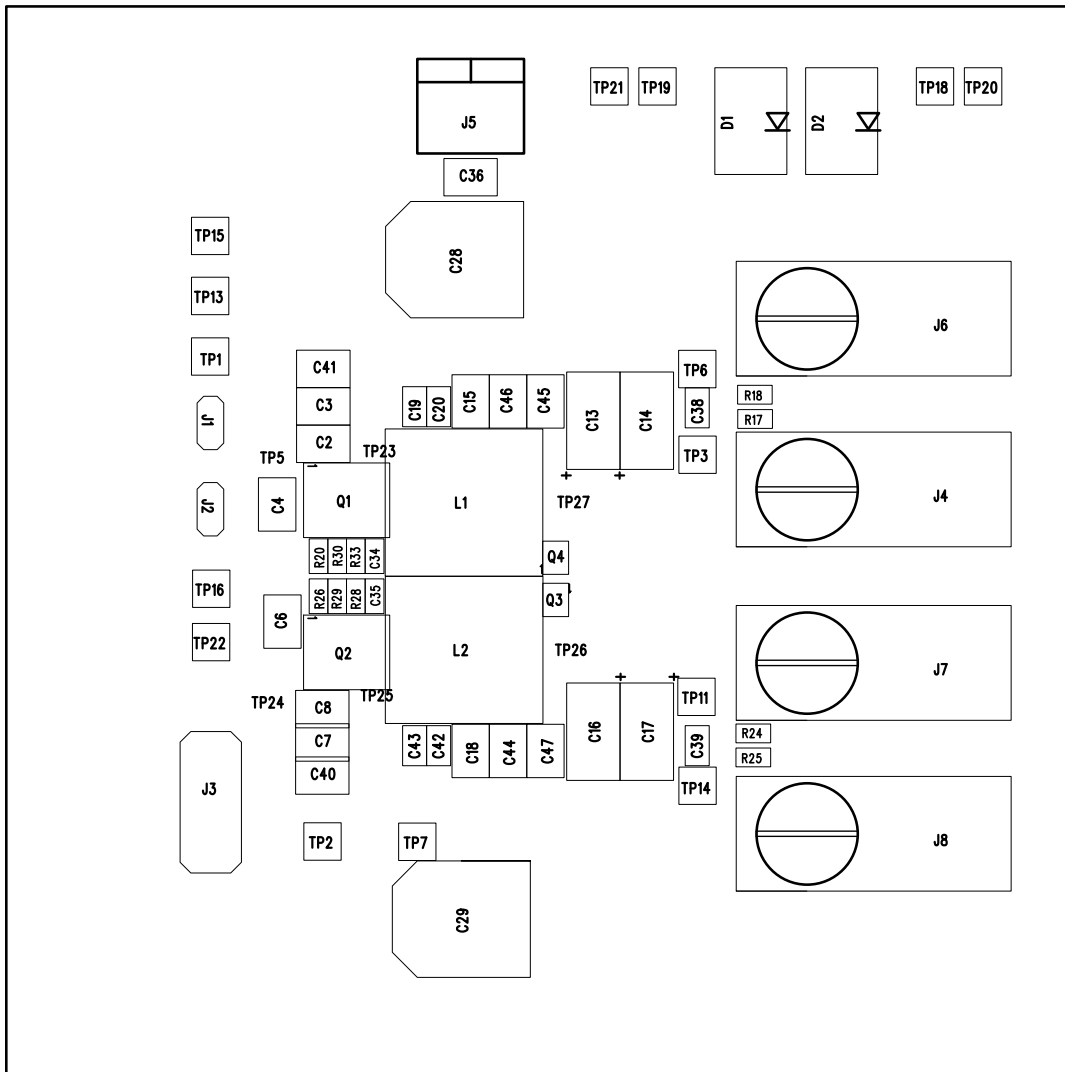

Figure 27. PWR091EVM Top Layer Assembly Drawing (Top View)

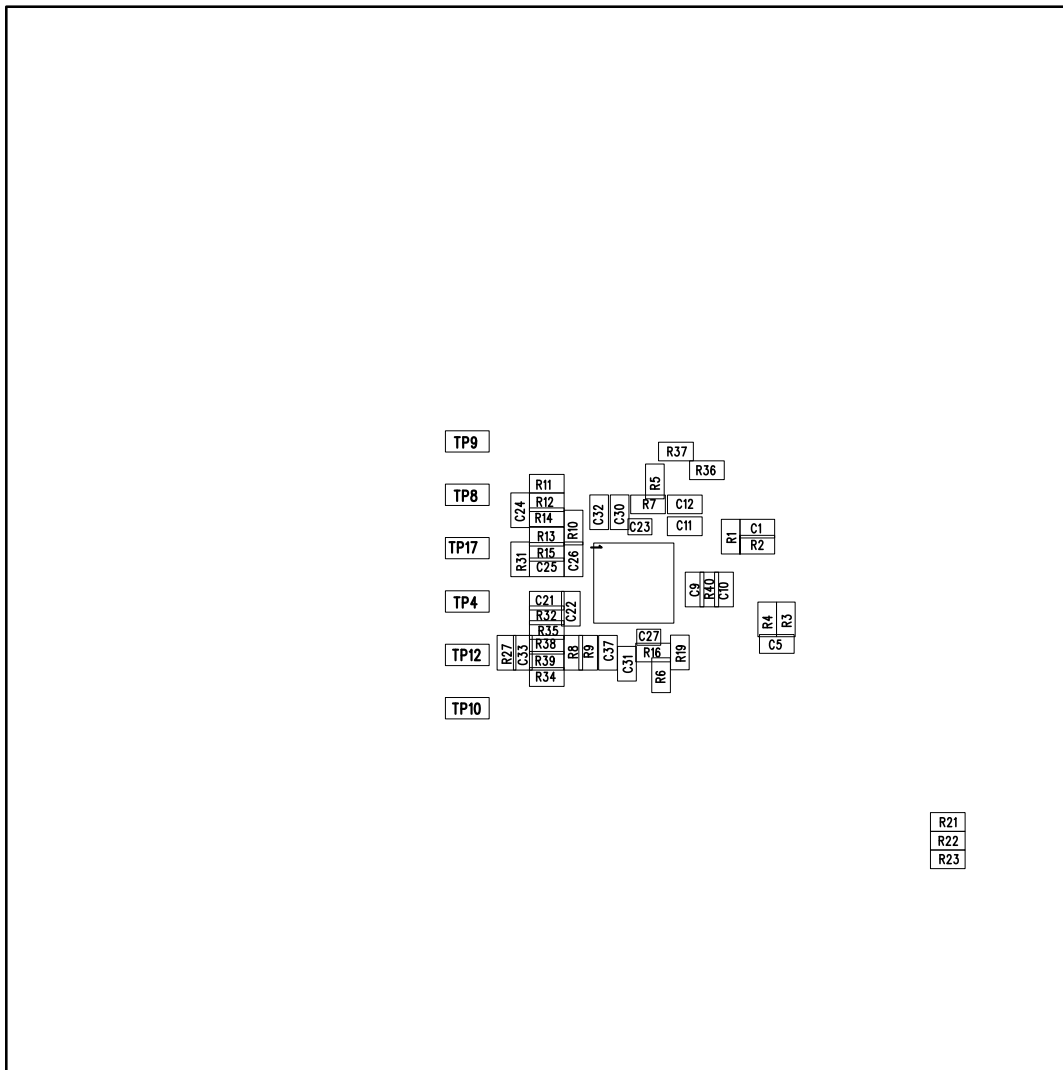

Figure 28. PWR091EVM Bottom Assembly Drawing (Bottom View)

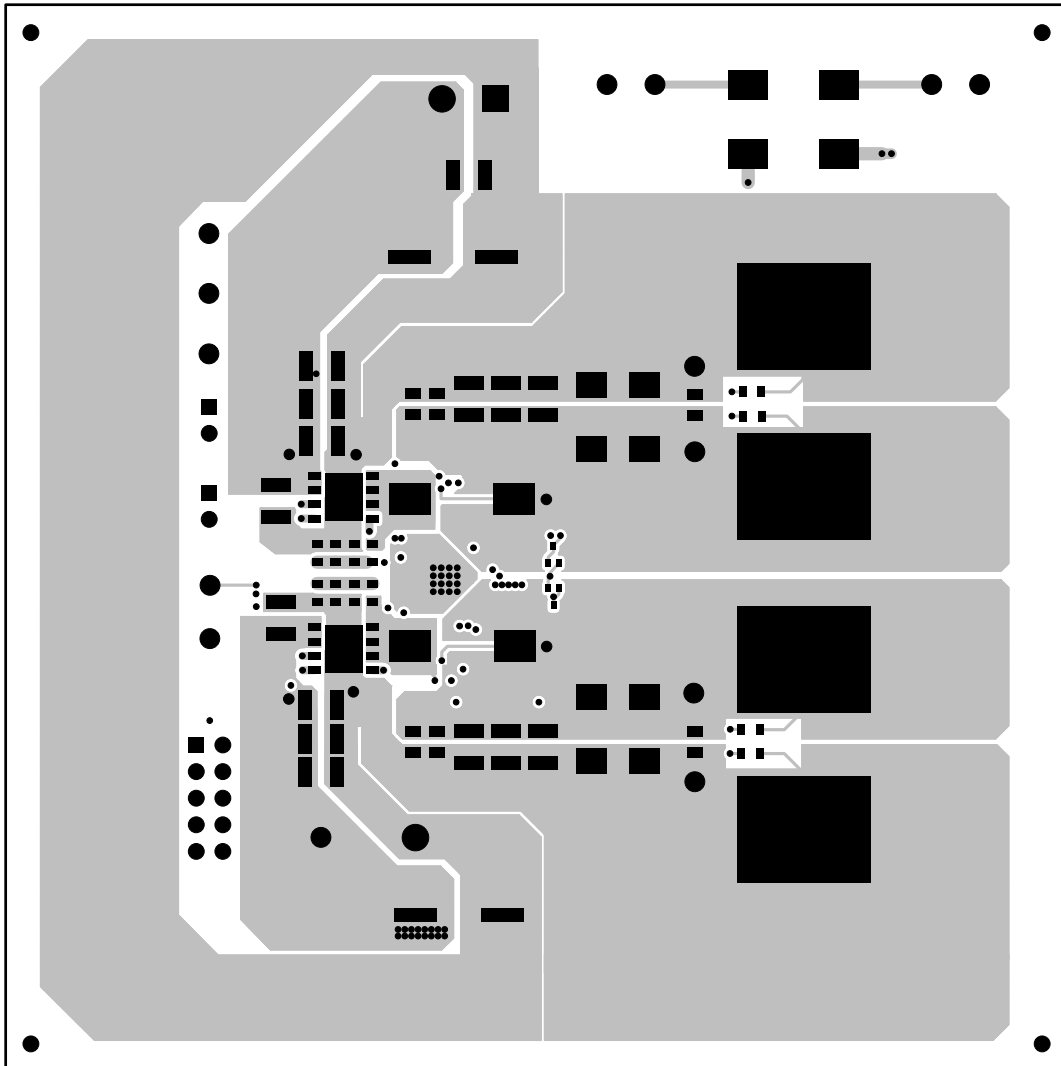

Figure 29. PWR091EVM Top Copper (Top View)

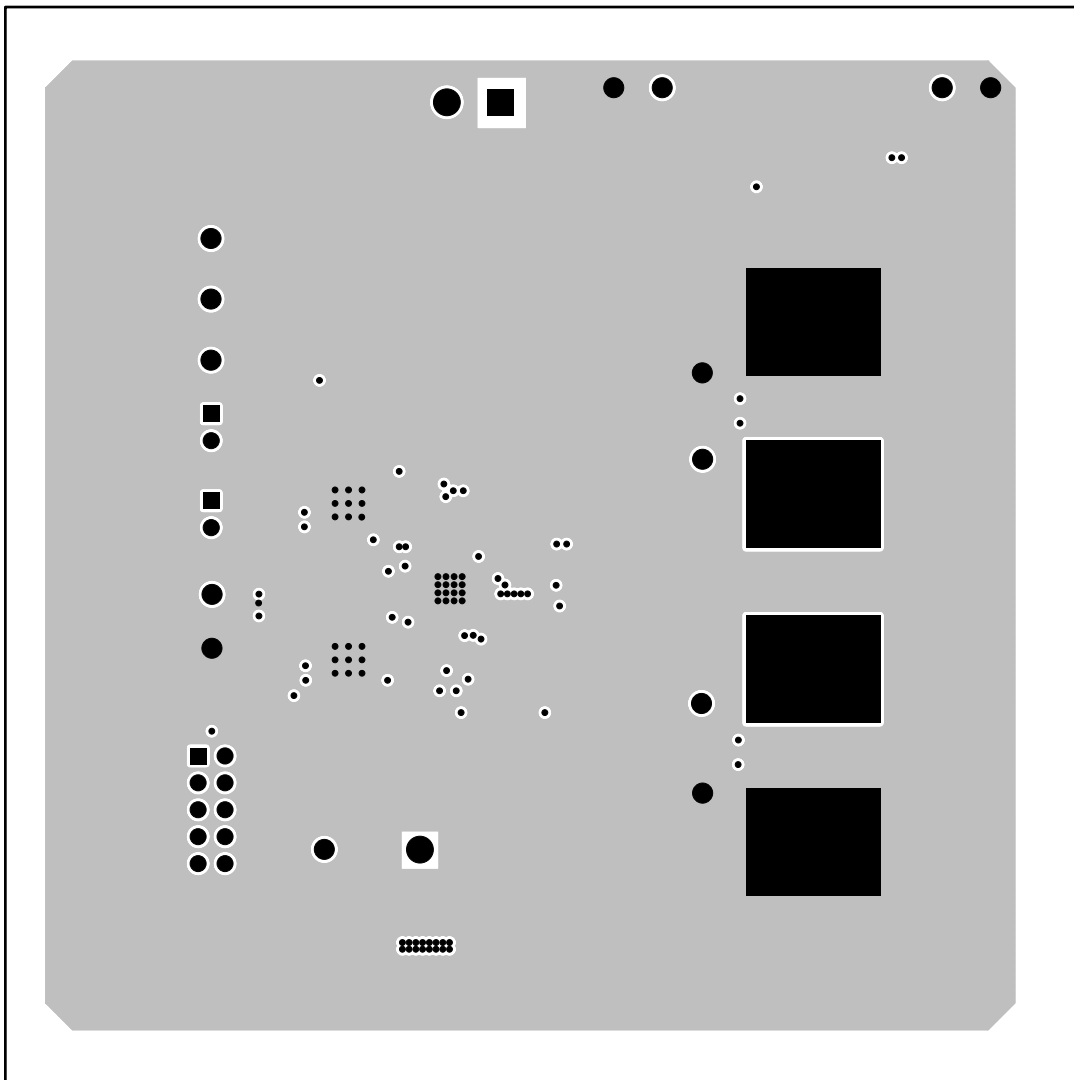

Figure 30. PWR091EVM Internal Layer 1 (Top View)

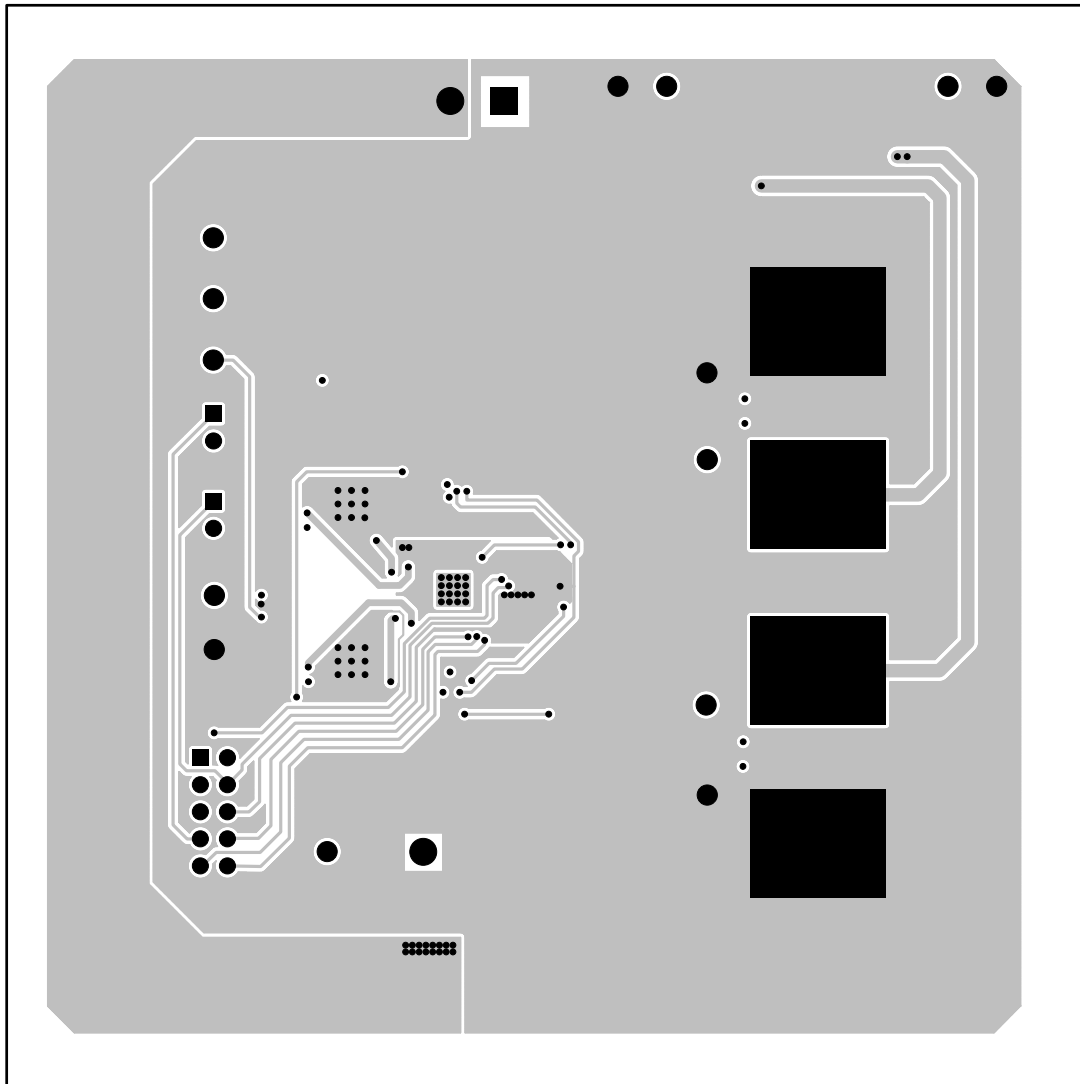

Figure 31. PWR091EVM Internal Layer 2 (Top View)

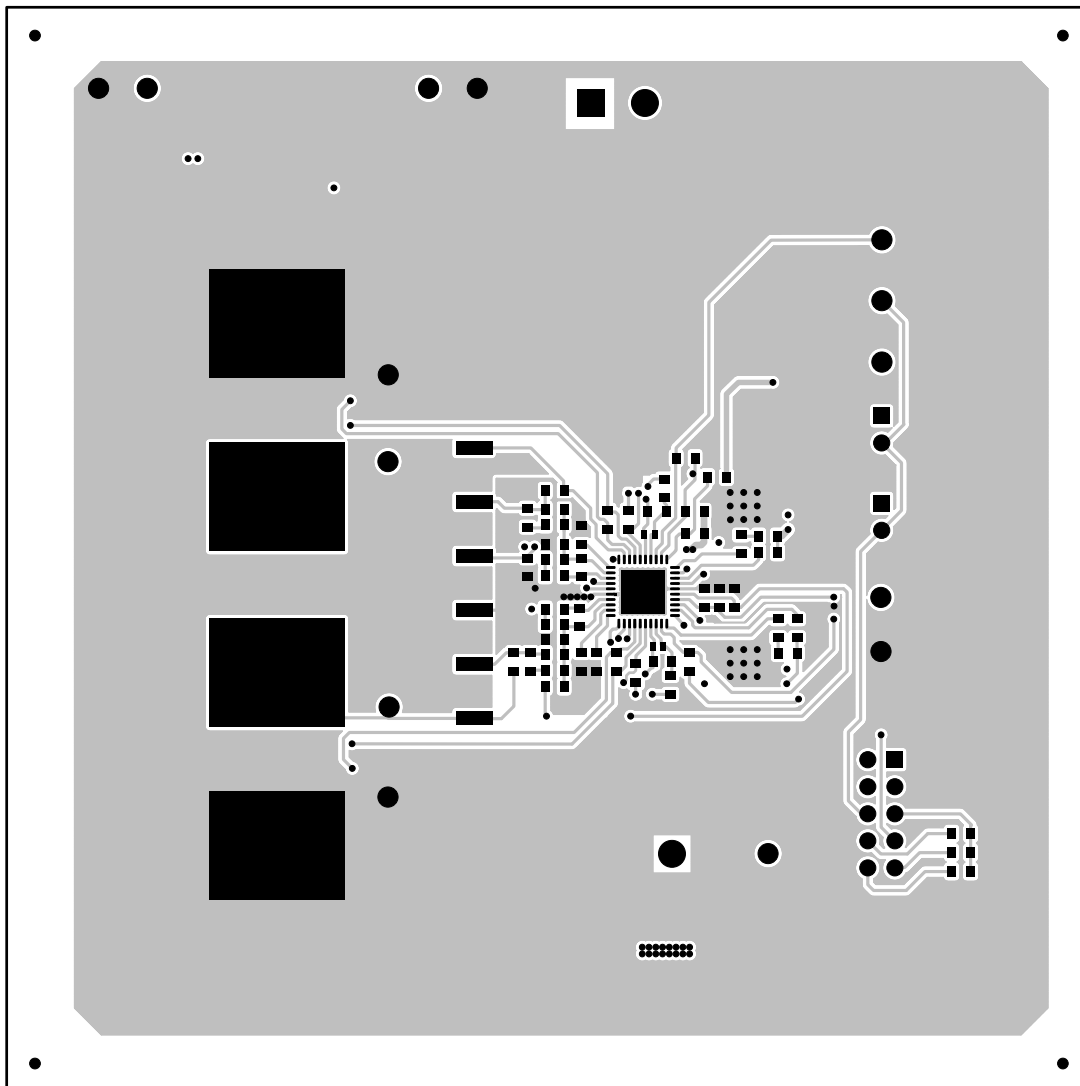

Figure 32. PWR091EVM Bottom Copper (Bottom View)

9 Bill of Materials

The EVM components list according to the schematic shown in .

Table 6. PWR091 Bill of Materials

Qty	Reference Designator	Description	Manufacturer	Part Number
2	C23 C27	0.47uF, Ceramic, 16V, X5R, 10%, 0402	STD	STD
3	C1 C5 C9	0.1uF, Ceramic, 50V, X7R, 10%, 0603	STD	STD
3	C10-12	1.0uF, Ceramic, 25V, X7R, 10%, 0603	STD	STD
2	C21 C25	1.2nF, Ceramic, 50V, X7R, 10%, 0603	STD	STD
2	C24 C33	470pF, Ceramic, 50V, X7R, 10%, 0603	STD	STD
2	C26 C22	120pF, Ceramic, 50V, NP0, 5%, 0603	STD	STD
6	C31-32 C30 C34-35 C37	1000pF, Ceramic, 50V, X7R, 10%, 0603	STD	STD
4	C19-20 C42-43	22uF, Ceramic, 6.3V, X5R, 20%, 0805	STD	STD
2	C38-39	0.1uF, Ceramic, 6.3V, X5R, 20%, 0805	STD	STD
9	C2-4 C6-8 C36 C40-41	22uF, Ceramic, 25V, X5R, 20%, 1210	STD	STD
6	C18 C15 C44-47	100uF, Ceramic, 6.3V, X5R, 20%, 1210	STD	STD
2	C28-29	330uF, Electrolytic, Aluminum, 25V, 200mohm, 270mArms, 0.406 x 0.406	Panasonic	EEE-TK1E331UP
4	C13-14 C16-17	330uF, Polymer Cap, 330uF, 6.3V, 0.015 Ohms, 20%, 7343(D)	Kemet	T520D337M006ATE015
4	J4 J6-8	33457, Lug, Solderless, #10 - #10-12 AWG, Copper/Tin, Uninsulated, 0.375 x 1.00"	Std	CX35-36-CY
2	D1-2	MBRS340, Diode, Schottky, 3A, 40V, SMC	Fairchild	MBRS340
2	J1-2	PEC02SAAN, Header, Male 2-pin, 100mil spacing,, 0.100" x 2	Sullins	PEC02SAAN
1	J3	AWHW10G, Header, Male 2x5-pin, 100mil spacing, 0.100" x 5 X 2	Assmann	AWHW10G-0202-T-R
2	L1-2	820nH, Inductor, SMT, 27A, Shielded, 20%, 0.9mOhm, 0.512" x 0.571"	Wurth	744355182
2	R1 R4	5.1, Resistor, Chip, 1/10W, 1%, 0603	STD	STD
1	R3	0, Resistor, Chip, 1/10W, 1%, 0603	STD	STD
1	R2	0, Resistor, Chip, 1/10W, 5%, 0603	STD	STD
2	R5-6	2.0k, Resistor, Chip, 1/10W, 1%, 0603	STD	STD
0	R7 R16 R21-23 R34	Open, Resistor, Chip, 1/10W, 1%, 0603	STD	STD
3	R12 R13 R38	47.5k, Resistor, Chip, 1/10W, 1%, 0603	STD	STD
2	R8-9	36.5k, Resistor, Chip, 1/10W, 1%, 0603	STD	STD
11	R17 R18 R20 R24-26 R28-30 R33 R36	10, Resistor, Chip, 1/10W, 1%, 0603	STD	STD
1	R10	40.2k, Resistor, Chip, 1/10W, 1%, 0603	STD	STD
3	R11 R27 R31	49.9, Resistor, Chip, 1/10W, 1%, 0603	STD	STD
2	R15 R32	20k, Resistor, Chip, 1/10W, 1%, 0603	STD	STD
1	R35	10.5k, Resistor, Chip, 1/10W, 1%, 0603	STD	STD
3	R19 R37 R40	10.0k, Resistor, Chip, 1/10W, 1%, 0603	STD	STD
2	R14 R39	4.75k, Resistor, Chip, 1/10W, 1%, 0603	STD	STD
1	J5	ED120/2DS, Terminal Block, 2-pin, 15-A, 5.1mm, 0.40" x 0.35"	OST	ED120/2DS
1	U1	TPS40422RHA, IC, PMBUS synchronous buck controller, QFN-40	TI	TPS40422RHA
2	Q1-2	CSD87350Q5D, MOSFET, Dual N-Chan, 30-V, 30-A, QFN-8 POWER	TI	CSD87350Q5D
2	Q3-4	MMBT3904, Bipolar, NPN, 40V, 200mA, 200mW, SC-75	On Semi	MMBT3904TT1G
1	PCB	PCB, FR-4, 0.062, 2oz Copper all layers., 4.00" x 4.00"	STD	STD

10 Screen Shots

10.1 Fusion GUI Screen Shots



Figure 33. First Window at Fusion Launch



Figure 34. Scan Finds Device Successfully

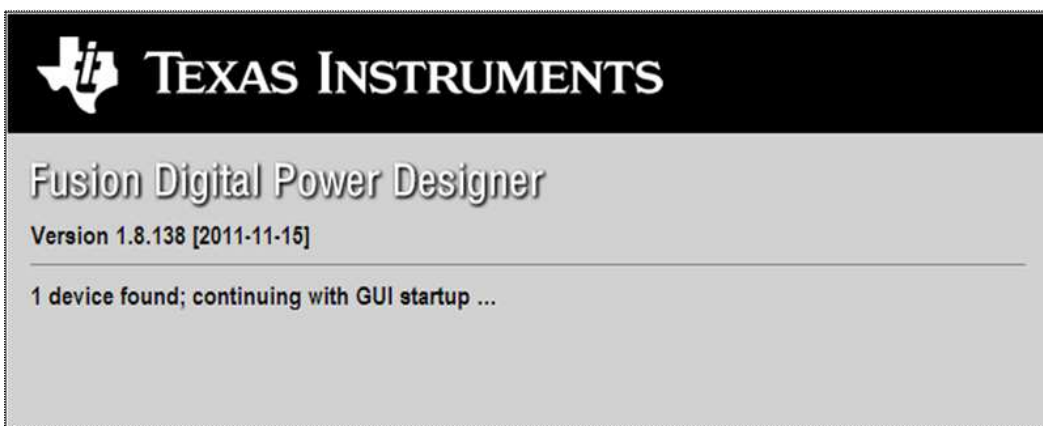

Figure 35. Software Launch Continued

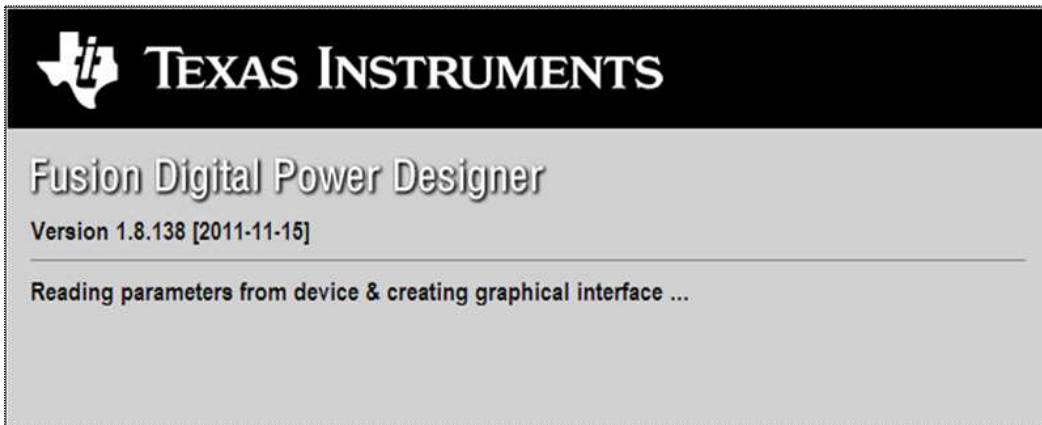

Figure 36. Software Launch Continued

Use this screen to configure (Figure 37):

- OC Fault and OC Warn
- OT Fault and OT Warn
- Power Good Limits
- Fault response
- UVLO
- On/Off Config
- Soft Start time
- Margin voltage

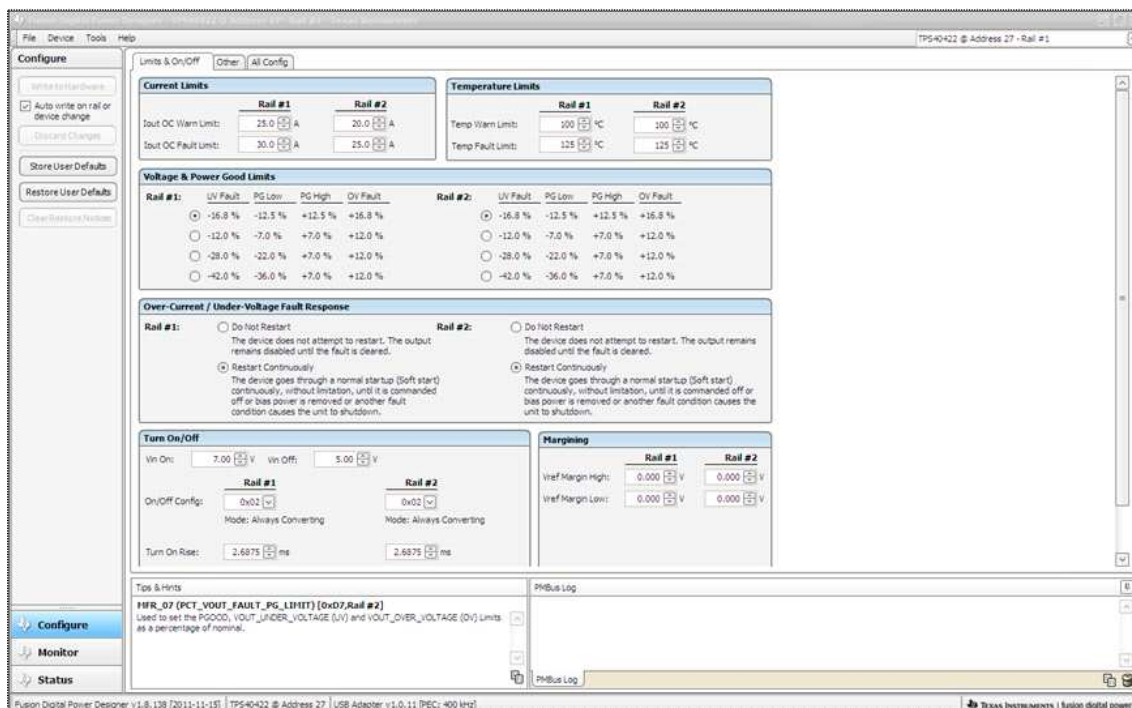

Figure 37. First Screen After Successful Launch: Configure- Limits & On/Off

Use this screen to configure (Figure 38) :

- Vref Trim

- Iout Cal Gain (DCR of output choke)

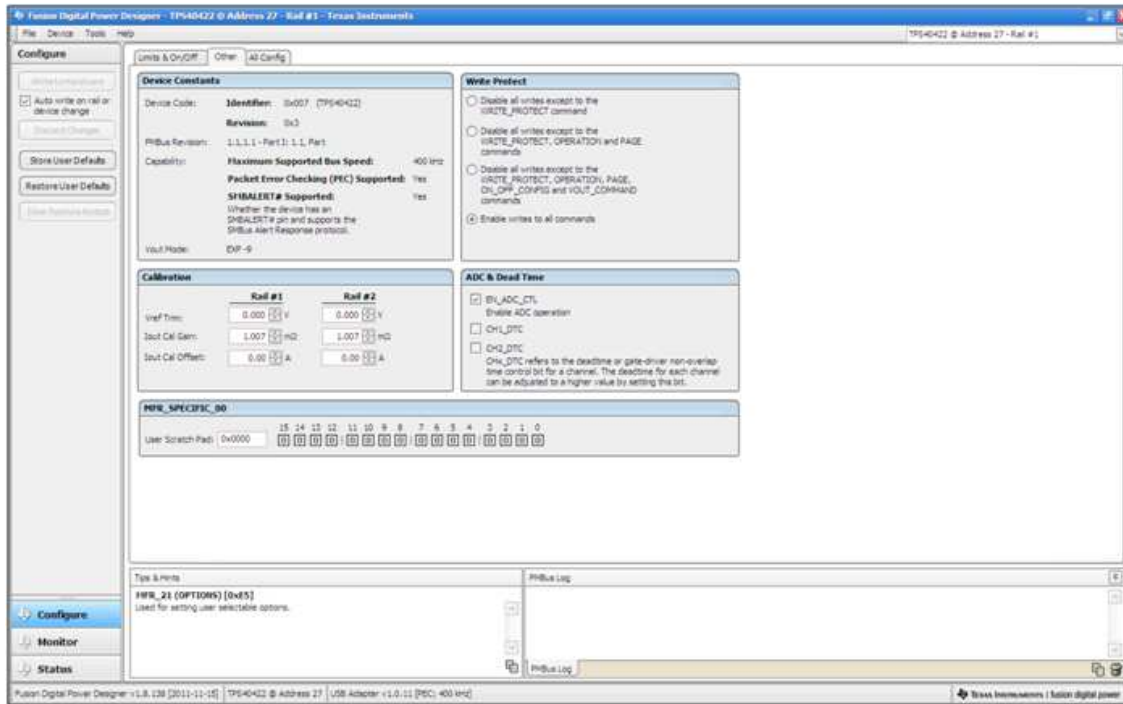

Figure 38. Configure- Other

Use this screen to configure all of the configurable parameters (Figure 39). The screen also shows other details like hexadecimal (hex) encoding.

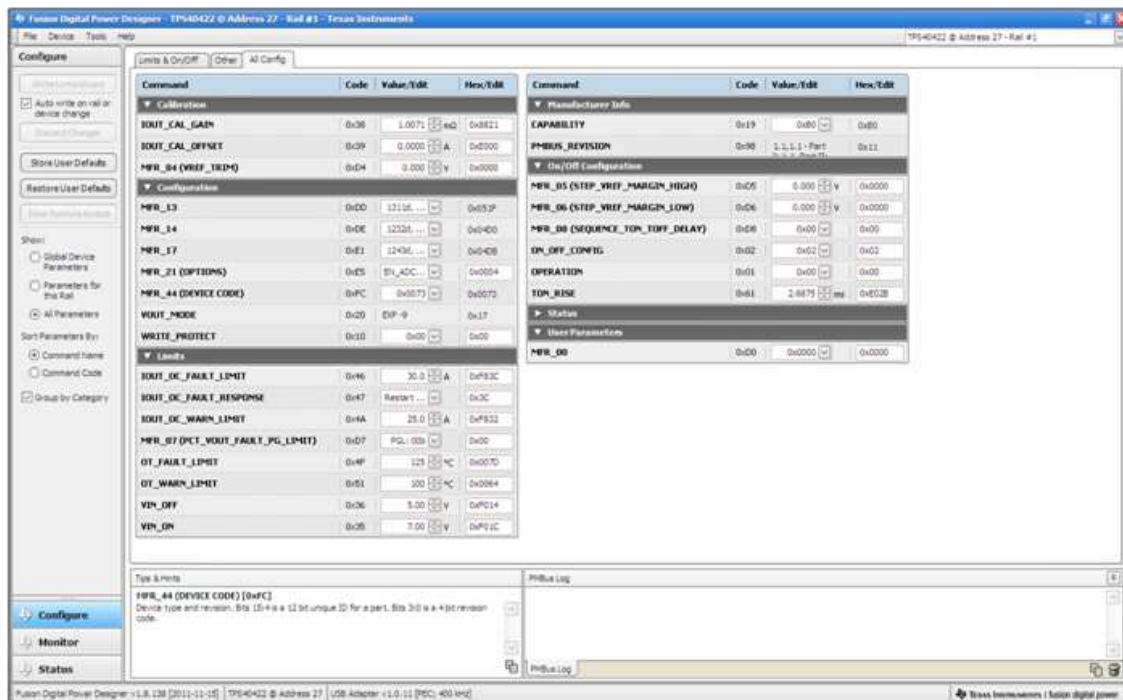

Figure 39. Configure- All

Changing the On/Off Config prompts a pop-up window with details of the options (Figure 40).

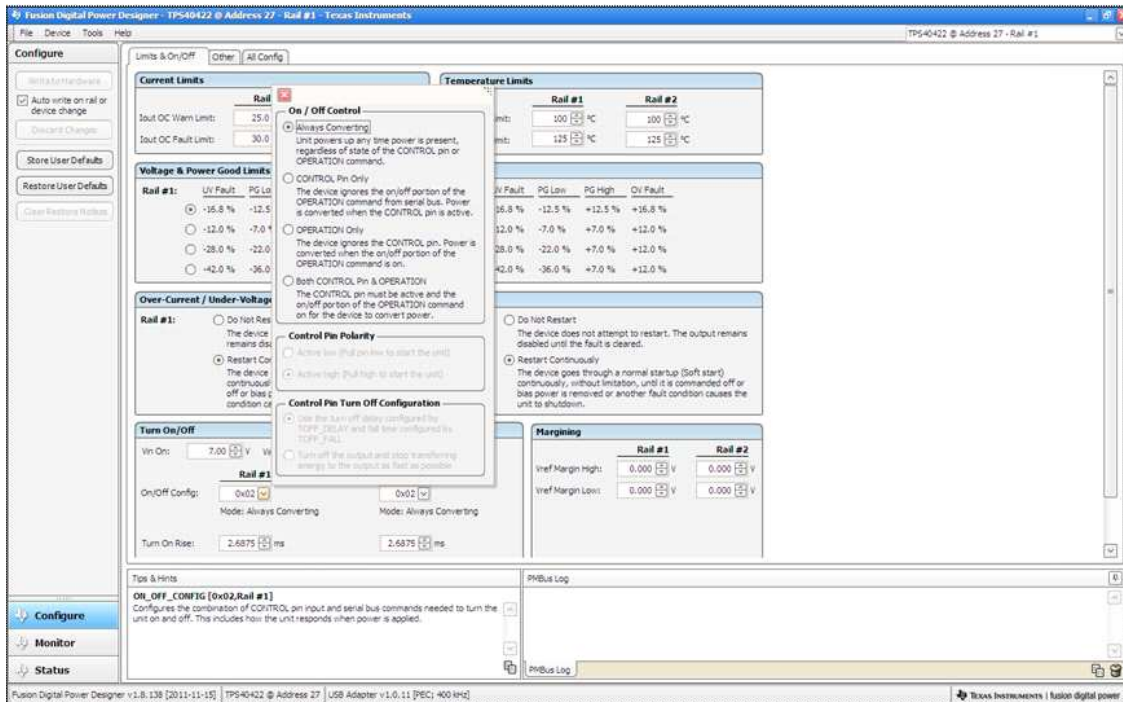

Figure 40. Configure- Limits and On/Off- On/Off Config Pop-up

After a change is selected, orange **U** icon is displayed to offer *Undo Change* option. Change is not retained until either *Write to Hardware* or *Store User Defaults* is selected. When *Write to Hardware* is selected, change is committed to volatile memory and defaults back to previous setting on input power cycle. When *Store User Defaults* is selected, change is committed to nonvolatile memory and becomes the new default (Figure 41).

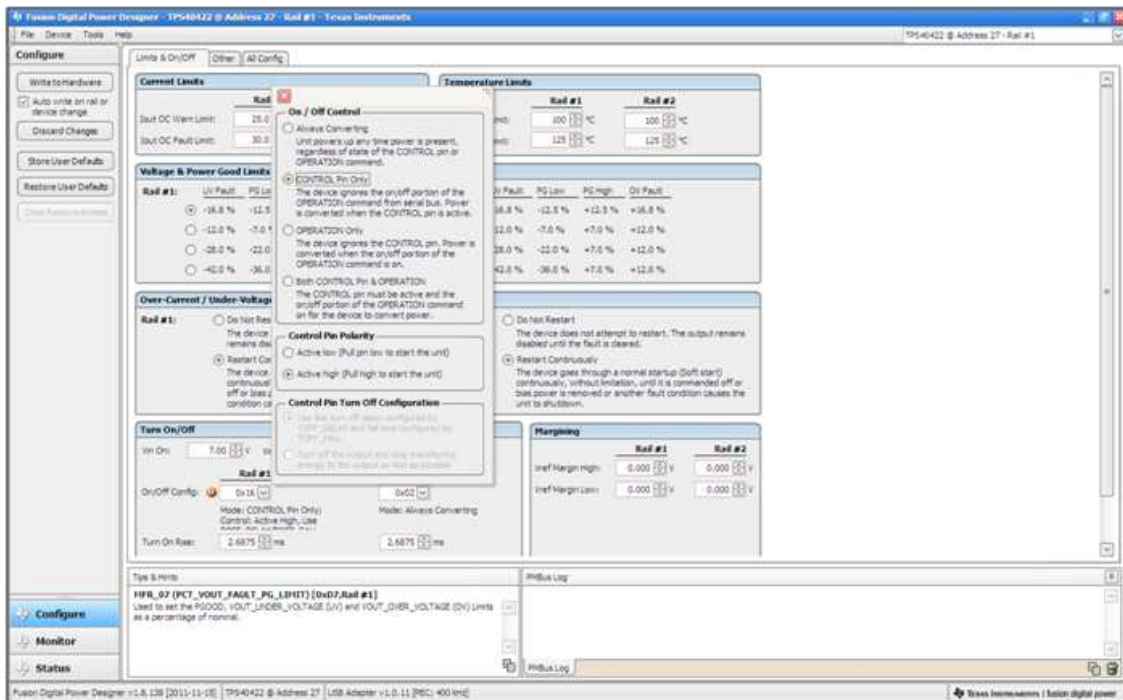

Figure 41. Configure- Limits and On/Off- On/Off Config Pop-up

The Iout Cal Gain can be typed in or scrolled to a new value. The range for Iout Cal Gain is 0.244 mΩ to 15.5 mΩ and the resolution step is 30.5 μΩ. If a value is typed in that is between the available discrete steps, the typed-in value does not change but the nearest discrete step is retained. The actual step is displayed on relaunch of the Fusion GUI (Figure 42).

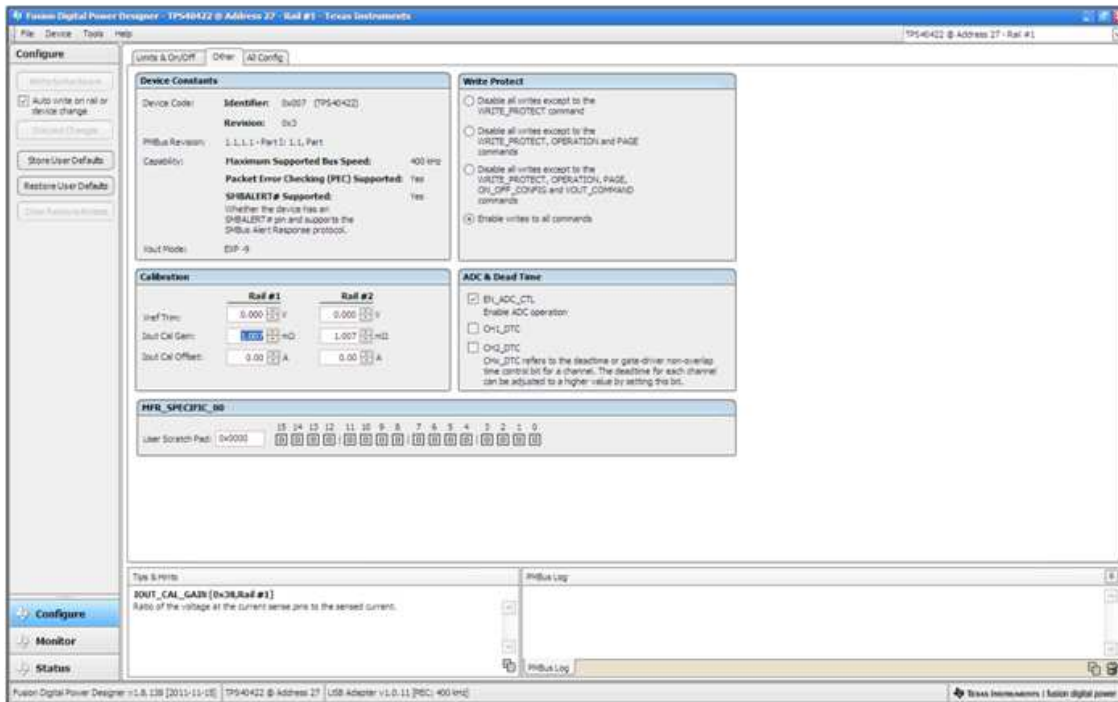

Figure 42. Configure- Other- Iout Cal Gain Change

On/Off Config can also be configured from the All Config screen, and the same process applies (Figure 43).

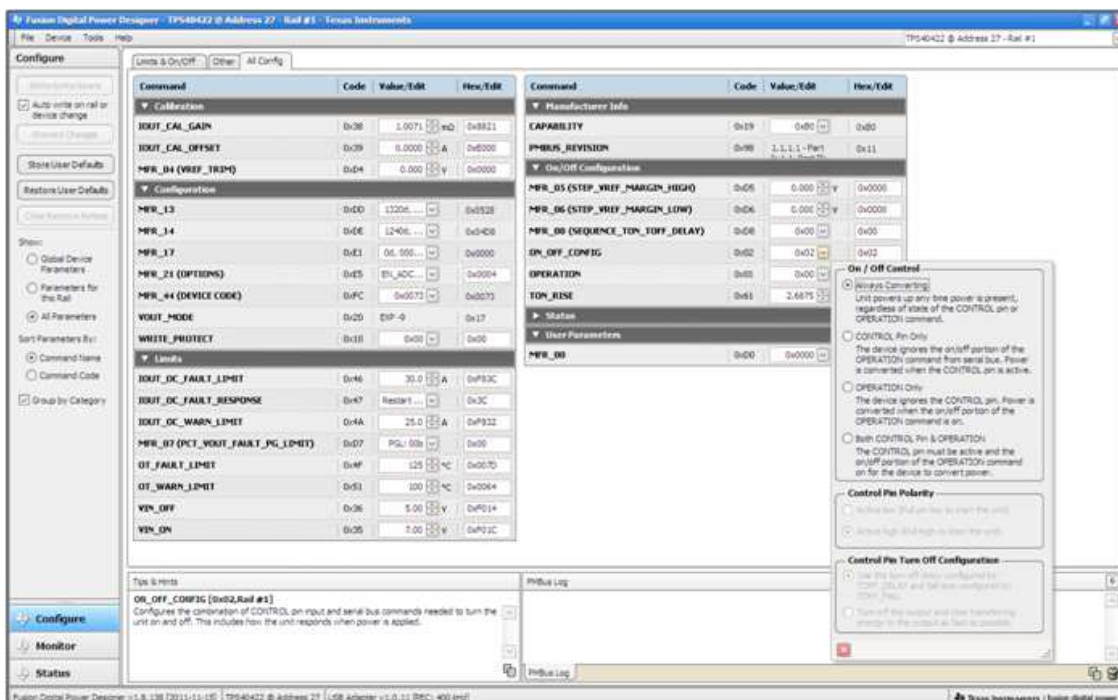

Figure 43. Configure- All Config- On/Off Config Pop-up

After making changes to one or more configurable parameters, the changes can be committed to nonvolatile memory by selecting *Store User Defaults*. This action prompts a *confirm selection* pop-up, and if confirmed, the changes are committed to nonvolatile memory (Figure 44).

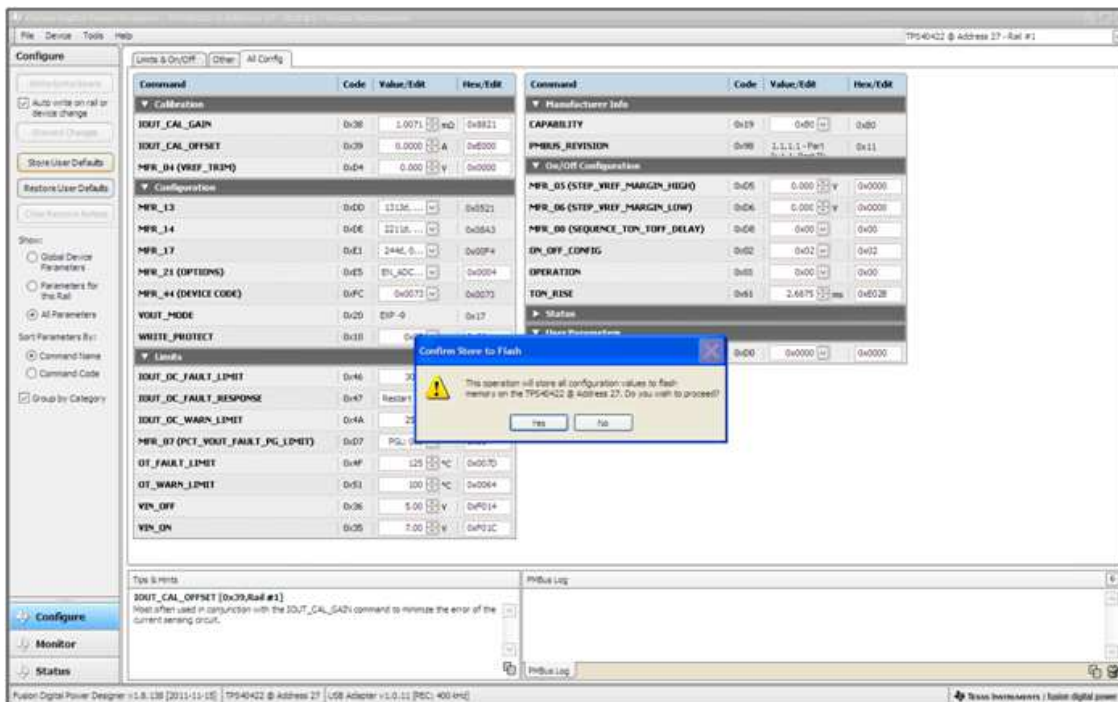

Figure 44. Configure- Store User Defaults

A scroll-down menu in the upper right corner can be selected to change the view screens to one output rail or the other(Figure 45).

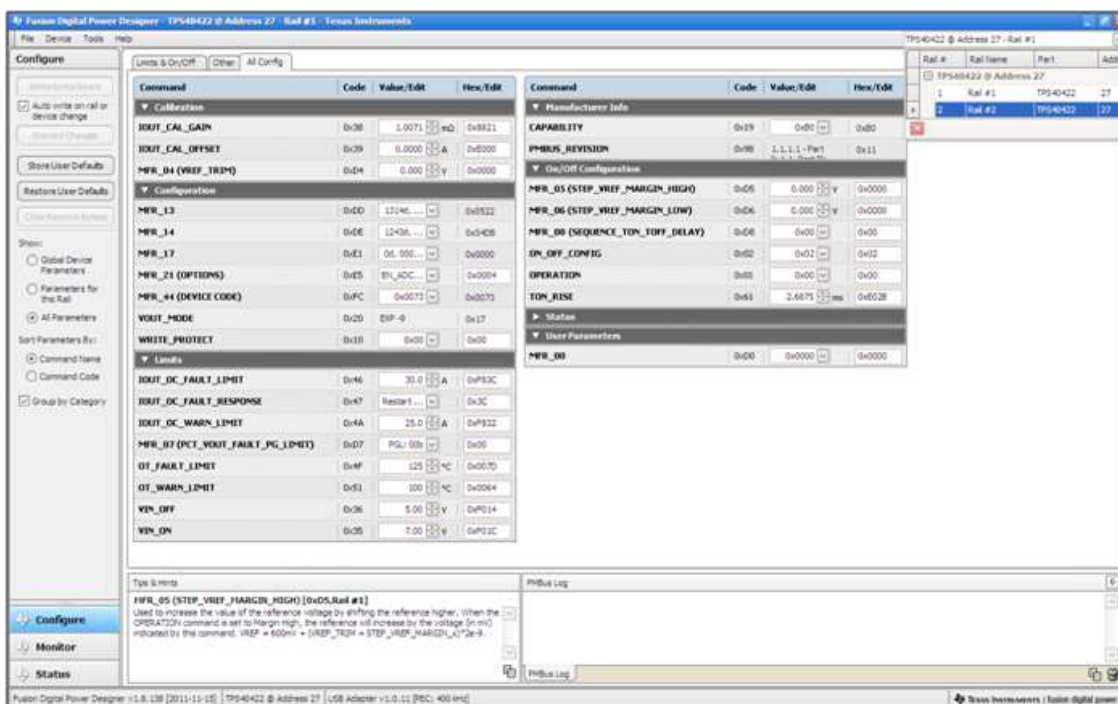

Figure 45. Change Screens to Other Vout Rail

In the lower left corner, the different view screens can be changed. The view screens can be changed between *Configure*, *Monitor* and *Status* as needed (Figure 46).

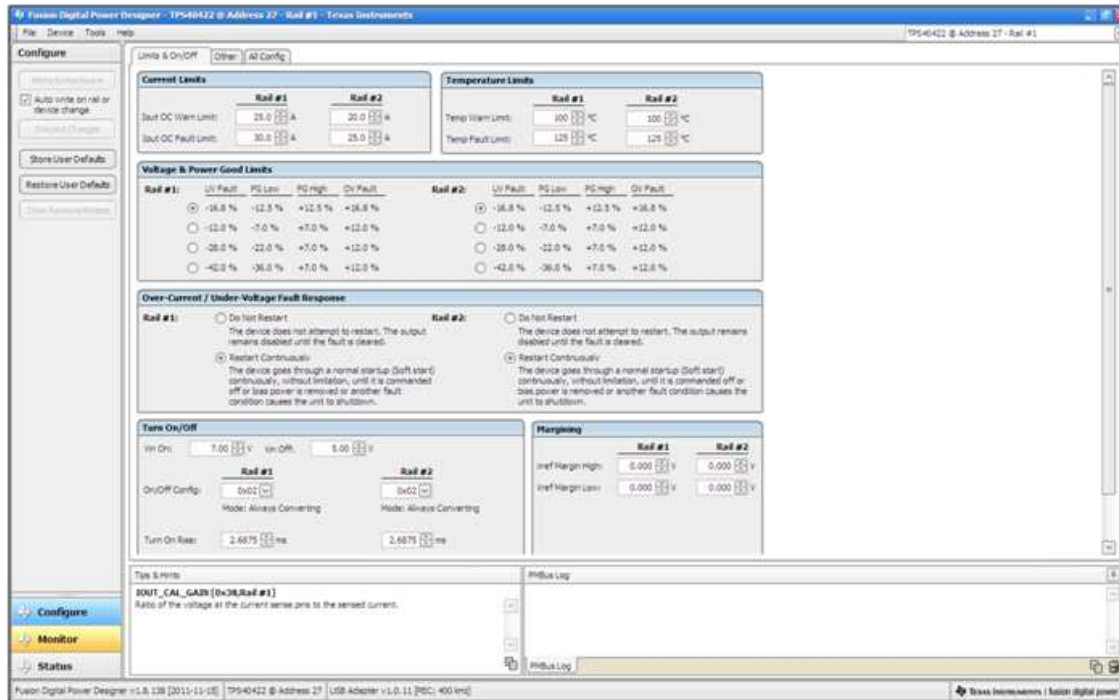

Figure 46. Change View Screen to Monitor Screen

When the *Monitor* screen is selected (Figure 47), the screen changes to display real-time data of the parameters that are measured by the controller. This screen provides access to:

- Graphs of *Vout*, *Iout*, *Temperature*, and *Pout*. As shown, *Pout* display is turned off.
- *Start/Stop Polling* which turns on or off the real-time display of data.
- Quick access to On/Off config
- Control pin activation, and OPERATION command. As shown, because the device is configured for *Always Converting*, these radio buttons are either grayed-out or have no effect.
- Margin control.
- PMBus log which displays activity on the PMBus.
- *Tips & Hints* which displays additional information when the cursor is hovered over configurable parameters.

As shown, when the EVM is still off due to UVLO, no output voltage or current is displayed.

At first GUI launch, Faults may occur due to communications during power up. These faults can be cleared once the device is enabled.

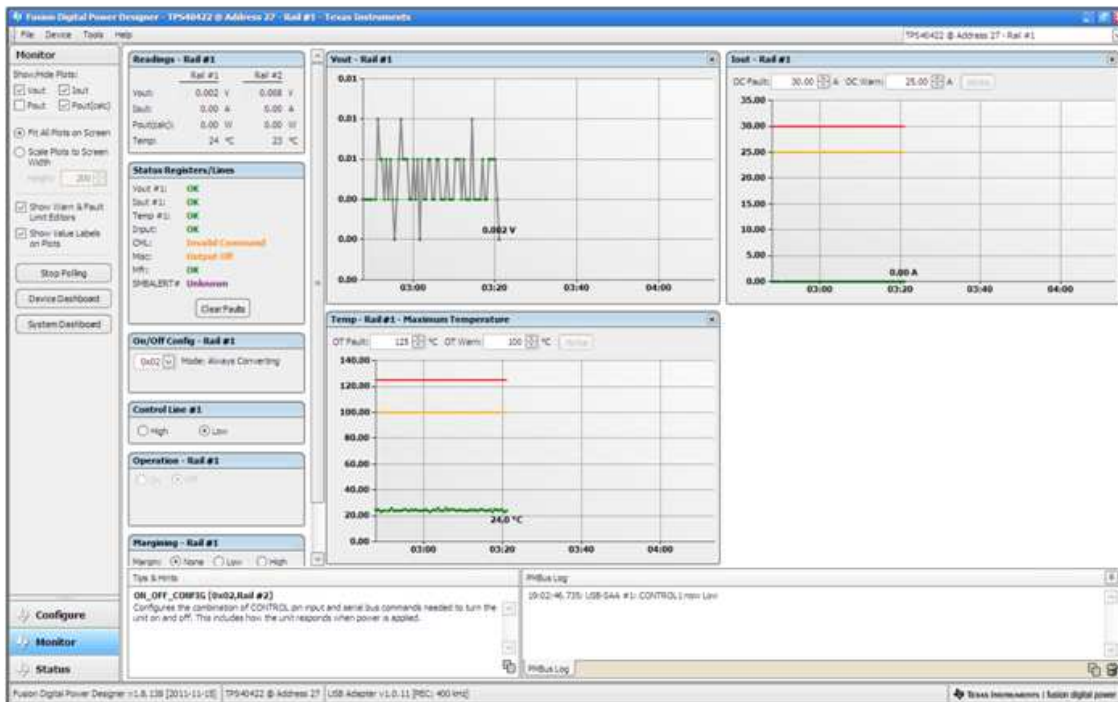

Figure 47. Monitor Screen

Selecting *System Dashboard* from mid-left screen adds a new window which displays system-level information (Figure 48).

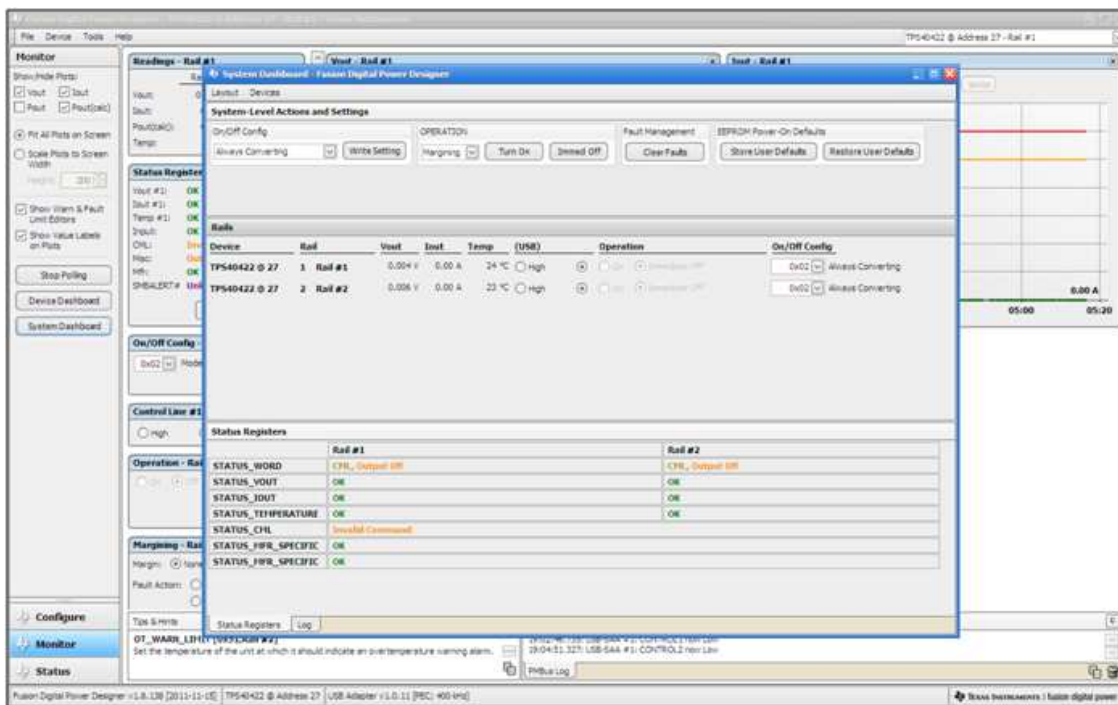

Figure 48. System Dashboard

When the EVM starts converting power, the Vout graph changes scale to display both the zero and Vout level. Only one rail can be displayed on the graphs at any time, but the other rail voltage, current, power, and temperature are displayed in the upper left window. Once the EVM is converting and clear of any faults, selecting *Clear Faults* clears any prior fault flags (Figure 49).

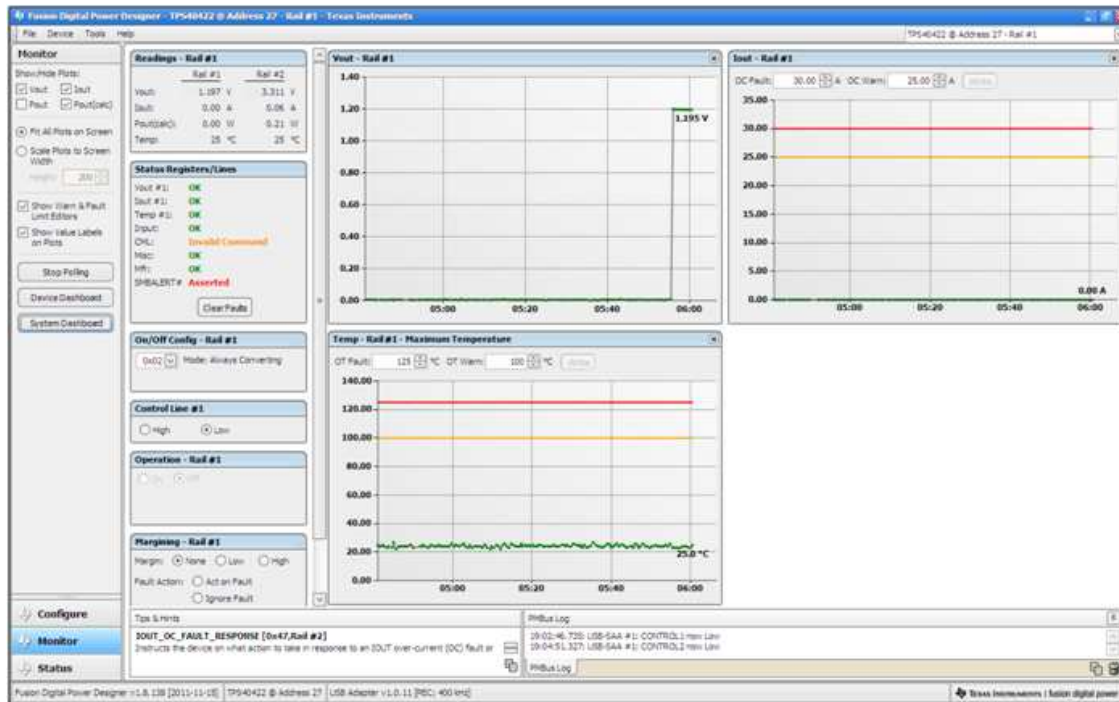

Figure 49. Display Change on Power Up

Selecting *Clear Faults* clears any prior fault flags. Scrolling time window of Vout still shows the turnon event (Figure 50).

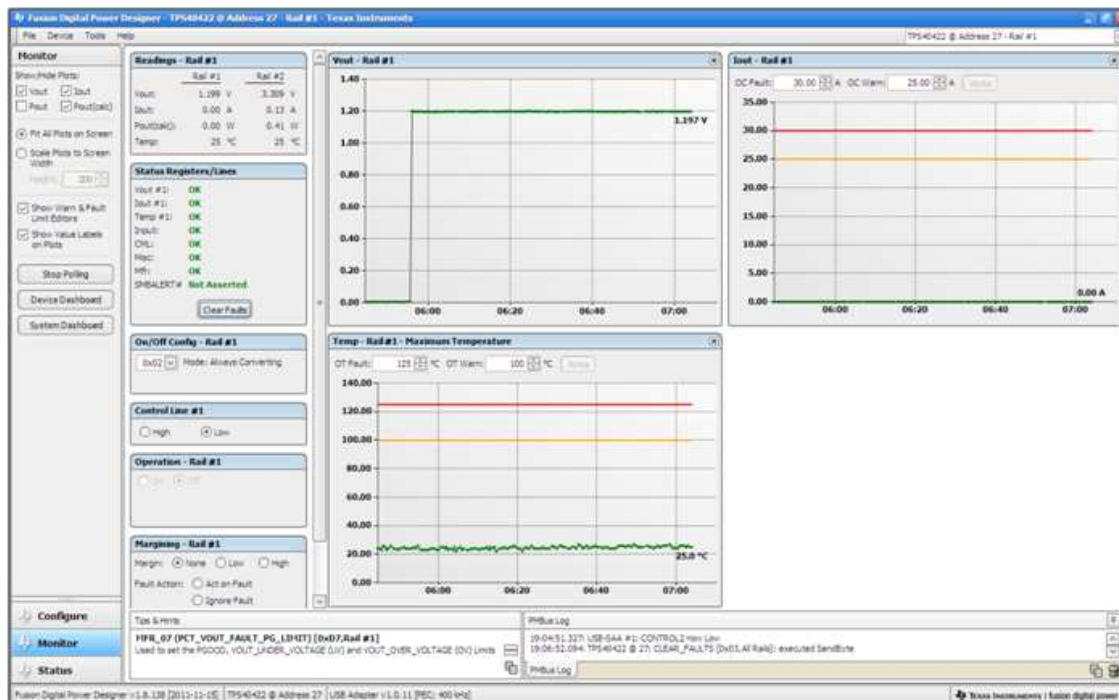

Figure 50. Faults Cleared

Selecting *Status* from lower left corner shows the status of the controller (Figure 51).

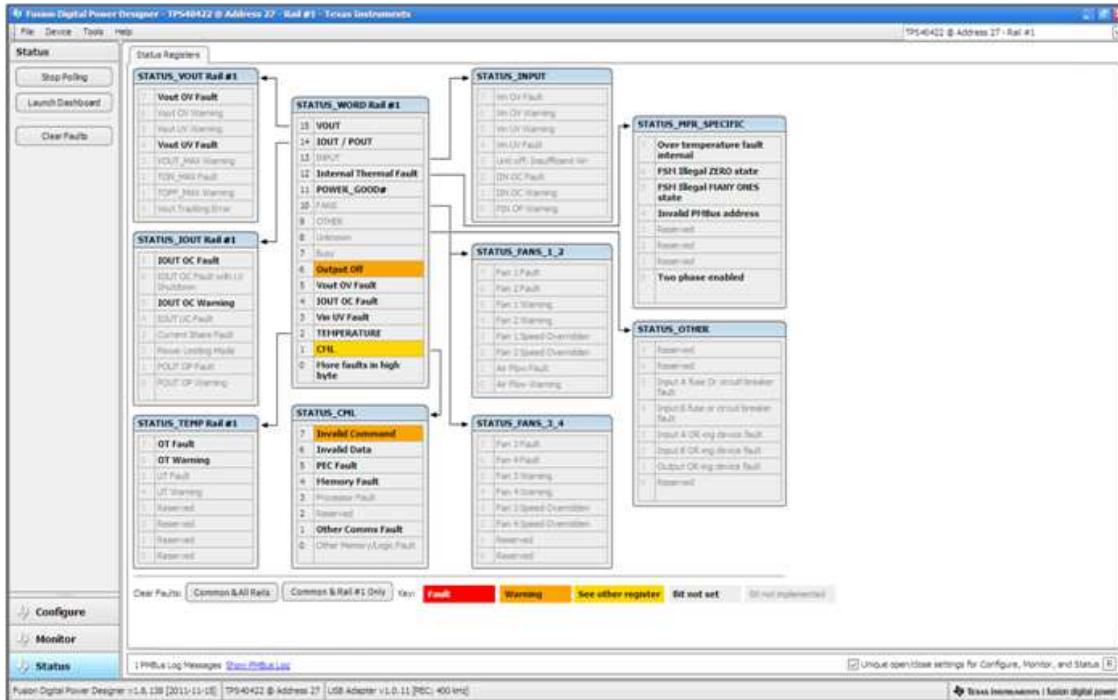

Figure 51. Status Screen

Selecting the pull-down menu *File- Import Project* from the upper left menu bar can be used to configure all parameters in the device at once with a desired configuration, or even revert back to a *known-good* configuration. This action results in a browse-type sequence where the desired config file can be located and loaded (Figure 52).

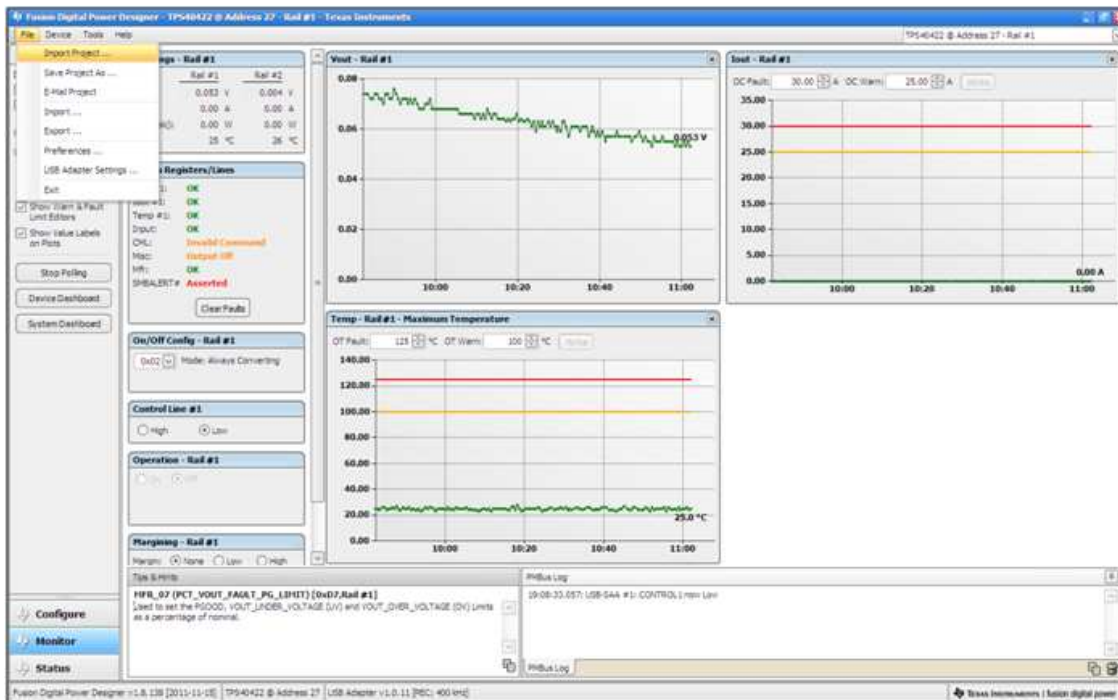

Figure 52. Import Project / Import Configuration File

Selecting *Store User Configuration to Flash Memory* from the Device pull-down menu has the same functionality as the *Store User Defaults* button from within the Configure screen. It results in committing the current configuration to nonvolatile memory (Figure 53).

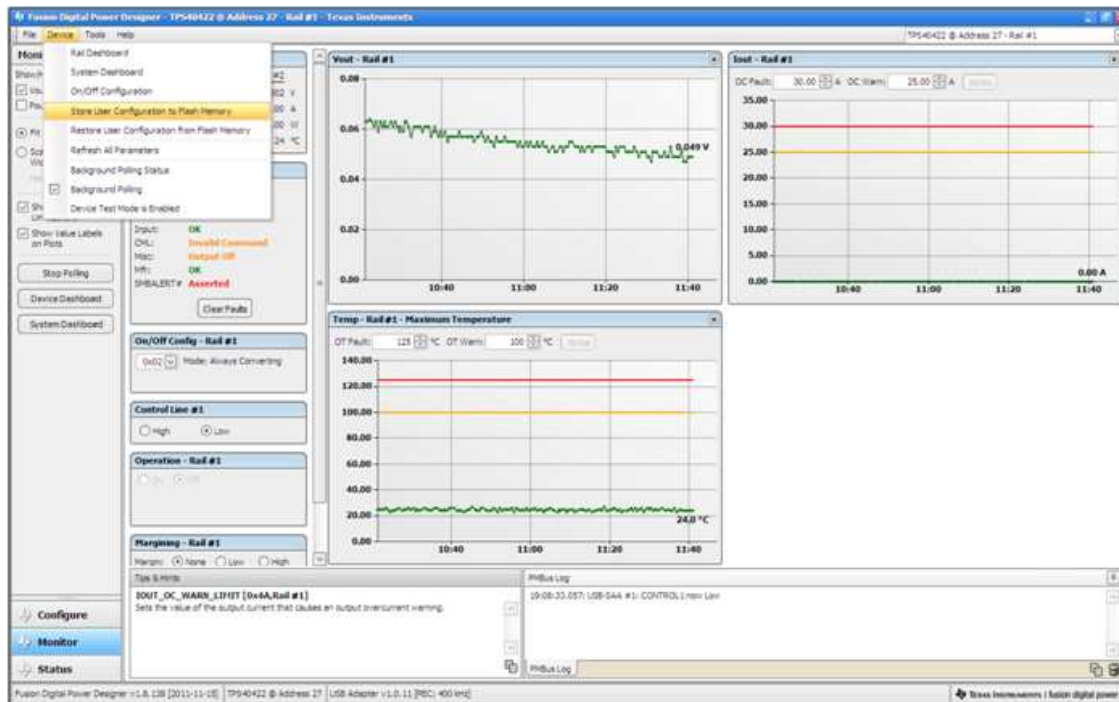

Figure 53. Store Config To Memory

Selecting *Data Logging* (Figure 54) from the Tools drop-down menu enables the logging of common operating values such as Vout, Iout, and Temperature for both output rails. The user is prompted to select a location for the file to be stored as well as the type of file. See next screen (Figure 55).



Figure 54. Data Logging

Select the storage location for the file and the type of file. As shown (Figure 55), the file will be a CSV file to be stored in the directory path shown. Logging begins when the *Start Data Logging* button is selected, and stops when it is reselected (as *Stop Data Logging*).

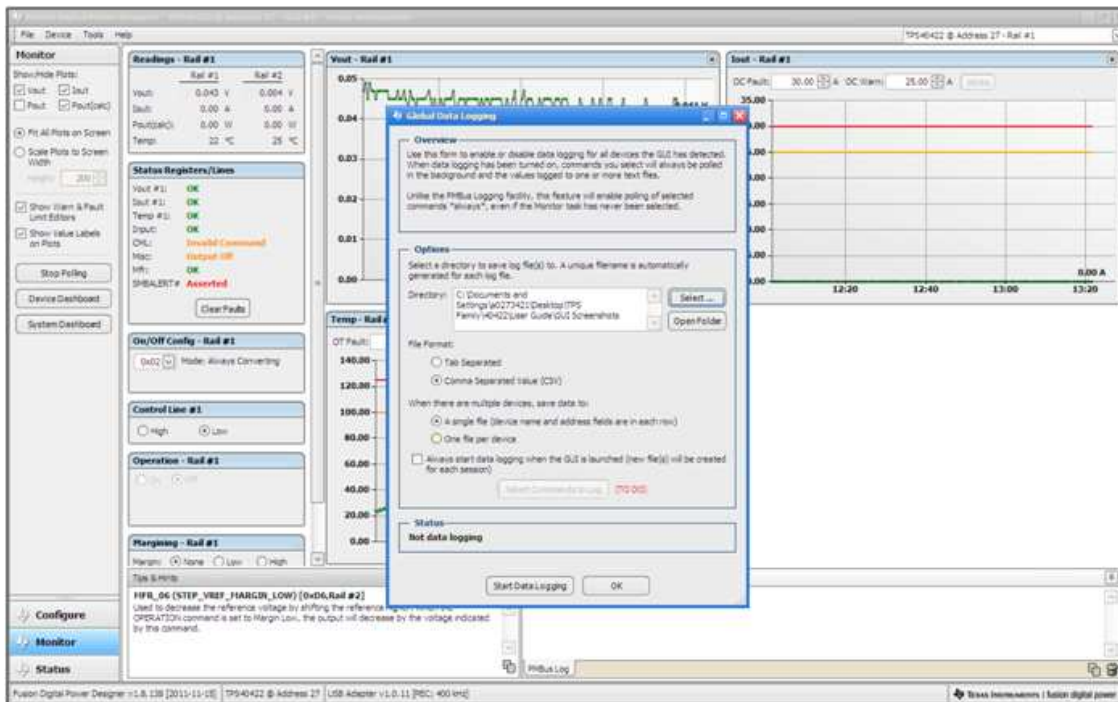

Figure 55. Data Logging Details

Data is stored in a CSV file, with date-stamp name (Figure 56).



Figure 56. Data Log

Common contents of the data log. As shown (Figure 57), the UUT had been disabled, and both rails were off .

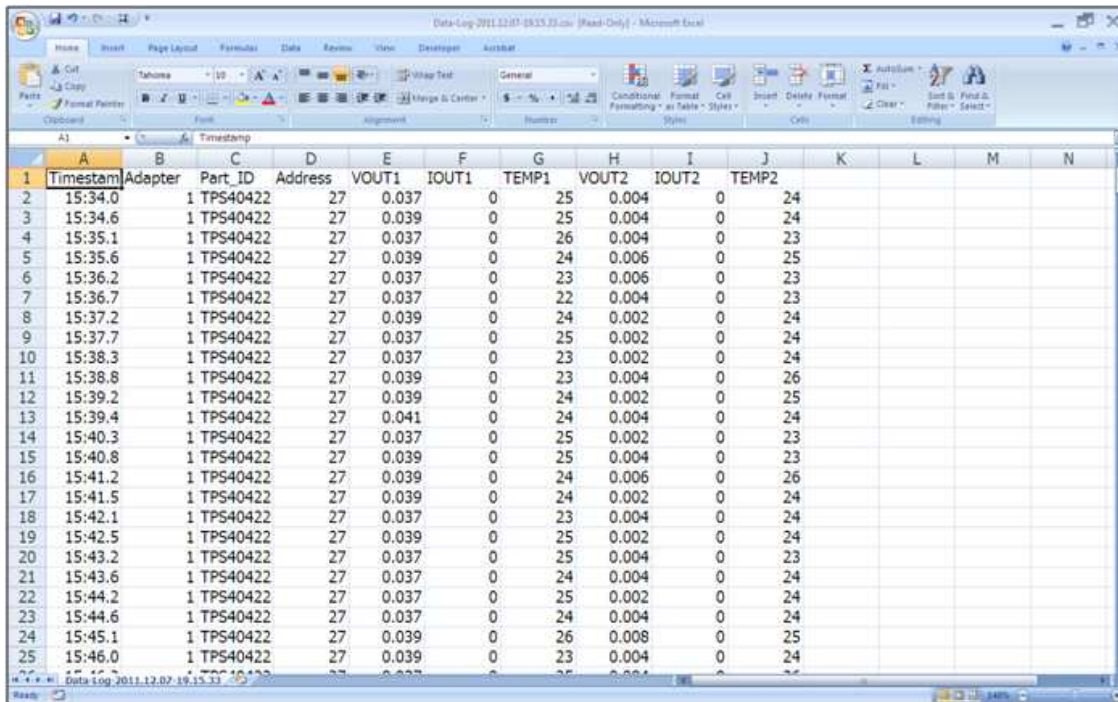

	A	B	C	D	E	F	G	H	I	J	K	L	M	N
	Timestamp	Adapter	Part_ID	Address	VOUT1	IOUT1	TEMP1	VOUT2	IOUT2	TEMP2				
2	15:34.0	1	TPS40422	27	0.037	0	25	0.004	0	24				
3	15:34.6	1	TPS40422	27	0.039	0	25	0.004	0	24				
4	15:35.1	1	TPS40422	27	0.037	0	26	0.004	0	23				
5	15:35.6	1	TPS40422	27	0.039	0	24	0.006	0	25				
6	15:36.2	1	TPS40422	27	0.037	0	23	0.006	0	23				
7	15:36.7	1	TPS40422	27	0.037	0	22	0.004	0	23				
8	15:37.2	1	TPS40422	27	0.039	0	24	0.002	0	24				
9	15:37.7	1	TPS40422	27	0.037	0	25	0.002	0	24				
10	15:38.3	1	TPS40422	27	0.037	0	23	0.002	0	24				
11	15:38.8	1	TPS40422	27	0.039	0	23	0.004	0	26				
12	15:39.2	1	TPS40422	27	0.039	0	24	0.002	0	25				
13	15:39.4	1	TPS40422	27	0.041	0	24	0.004	0	24				
14	15:40.3	1	TPS40422	27	0.037	0	25	0.002	0	23				
15	15:40.8	1	TPS40422	27	0.039	0	25	0.004	0	23				
16	15:41.2	1	TPS40422	27	0.039	0	24	0.006	0	26				
17	15:41.5	1	TPS40422	27	0.039	0	24	0.002	0	24				
18	15:42.1	1	TPS40422	27	0.037	0	23	0.004	0	24				
19	15:42.5	1	TPS40422	27	0.039	0	25	0.002	0	24				
20	15:43.2	1	TPS40422	27	0.037	0	25	0.004	0	23				
21	15:43.6	1	TPS40422	27	0.037	0	24	0.004	0	24				
22	15:44.2	1	TPS40422	27	0.037	0	25	0.002	0	24				
23	15:44.6	1	TPS40422	27	0.037	0	24	0.004	0	24				
24	15:45.1	1	TPS40422	27	0.039	0	26	0.008	0	25				
25	15:46.0	1	TPS40422	27	0.039	0	23	0.004	0	24				

Figure 57. Data Log File

Selecting *PMBus Logging* (Figure 58) from the Tools drop-down menu enables the logging of all PMBus activity. This includes communications traffic for each polling loop between the GUI and the device. It also includes common operating values such as Vout, Iout, and Temperature for both output rails. The user is prompted to select a location for the file to be stored. See next screen (Figure 59).

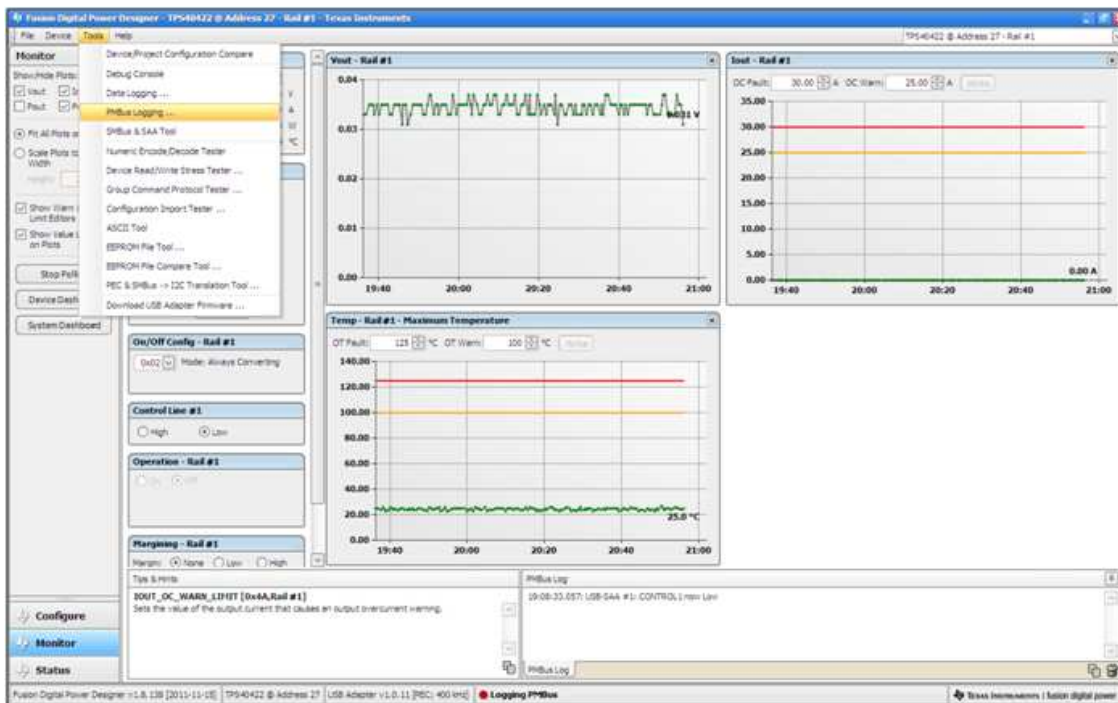

Figure 58. PMBus Logging

Select the storage location for the file and the type of file. As shown (Figure 59), the file is a CSV file to be stored in the directory path shown. Logging begins when the *Start Logging* button is selected, and stops when it is reselected (as *Stop Logging*). This file can rapidly grow in size, so caution is advised when using this function.

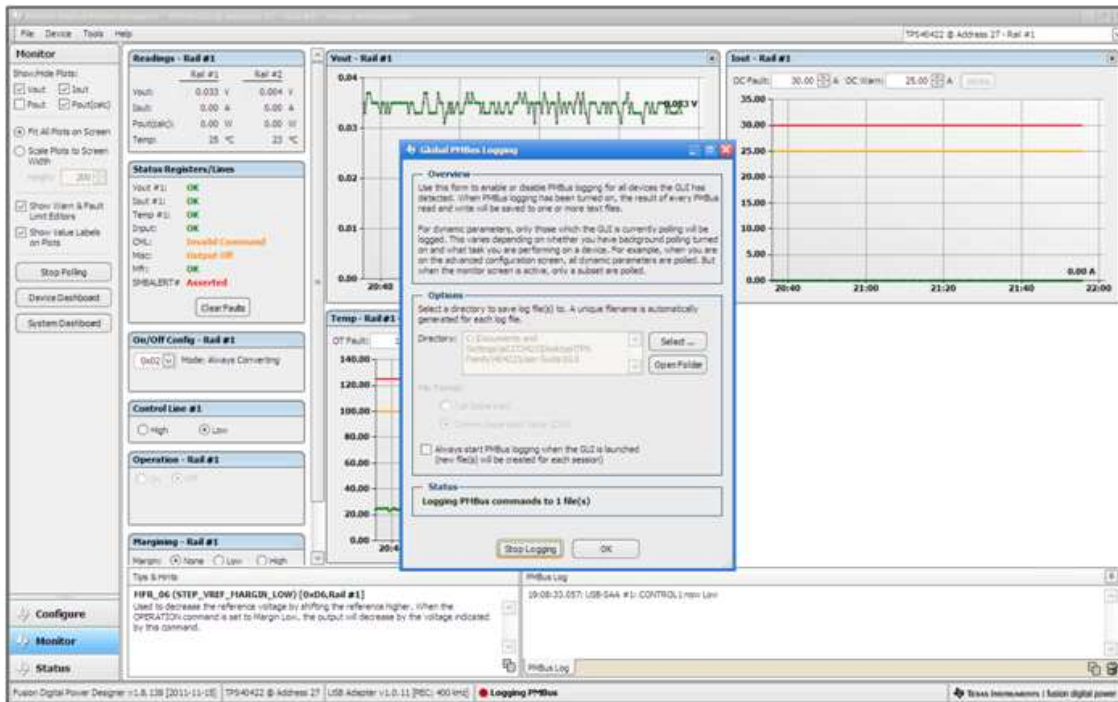

Figure 59. PMBus Log Details

Data is stored in a CSV file, with date-stamp name (Figure 60).

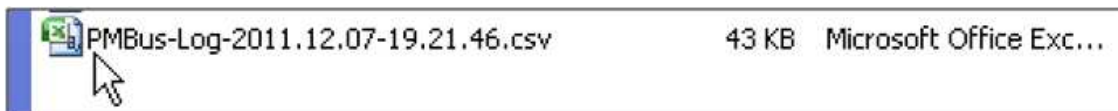

Figure 60. PMBus Log

Common contents of the PMBus log. As shown (Figure 61), the UUT had been disabled, and both rails were off.

Timestamp	Category	Adapter	Address	Part_ID	ID	Code	Page	Phase	Request	Status	Num_Atter	Value_Eno	Value_Tex	Value_Numeric
21:46.3	SAA	1	27	TPS40422	PAGE	0x00			ReadByte	ACK	1	0x00		
21:46.3	PMBus	1	27	TPS40422	PAGE	0x00			WRITE	ACK	1	0x00	Rail #1 / PAGE	0x00
21:46.3	SAA	1	27	TPS40422	READ_VOI	0x8B			ReadWord	ACK	1	0x0012		
21:46.3	PMBus	1	27	TPS40422	READ_VOI	0x8B	0x00		READ	ACK	1	0x0012	0.035 V	0.035
21:46.3	SAA	1	27	TPS40422	PAGE	0x00			WriteByte	ACK	1	0x01		
21:46.3	SAA	1	27	TPS40422	PAGE	0x00			ReadByte	ACK	1	0x01		
21:46.3	PMBus	1	27	TPS40422	PAGE	0x00			WRITE	ACK	1	0x01	Rail #2 / PAGE	0x01
21:46.3	SAA	1	27	TPS40422	READ_VOI	0x8B			ReadWord	ACK	1	0x0002		
21:46.3	PMBus	1	27	TPS40422	READ_VOI	0x8B	0x01		READ	ACK	1	0x0002	0.004 V	0.004
21:46.4	SAA	1	27	TPS40422	PAGE	0x00			WriteByte	ACK	1	0x00		
21:46.4	SAA	1	27	TPS40422	PAGE	0x00			ReadByte	ACK	1	0x00		
21:46.4	PMBus	1	27	TPS40422	PAGE	0x00			WRITE	ACK	1	0x00	Rail #1 / PAGE	0x00
21:46.4	SAA	1	27	TPS40422	READ_IOL	0x8C			ReadWord	ACK	1	0xE000		
21:46.4	PMBus	1	27	TPS40422	READ_IOL	0x8C	0x00		READ	ACK	1	0xE000	0.00 A	0
21:46.4	SAA	1	27	TPS40422	READ_TEM	0x8E			ReadWord	ACK	1	0x0018		
21:46.4	PMBus	1	27	TPS40422	READ_TEM	0x8E	0x00		READ	ACK	1	0x0018	24 C	24
21:46.5	SAA	1	27	TPS40422	STATUS_V	0x79			ReadWord	ACK	1	0x0042		
21:46.5	PMBus	1	27	TPS40422	STATUS_V	0x79	0x00		READ	ACK	1	0x0042	CML_OFF	
21:46.5	SAA	1	27	TPS40422	PAGE	0x00			WriteByte	ACK	1	0x01		
21:46.5	SAA	1	27	TPS40422	PAGE	0x00			ReadByte	ACK	1	0x01		
21:46.5	PMBus	1	27	TPS40422	PAGE	0x00			WRITE	ACK	1	0x01	Rail #2 / PAGE	0x01
21:46.6	SAA	1	27	TPS40422	READ_IOL	0x8C			ReadWord	ACK	1	0xE000		
21:46.6	PMBus	1	27	TPS40422	READ_IOL	0x8C	0x01		READ	ACK	1	0xE000	0.00 A	0
21:46.6	SAA	1	27	TPS40422	READ_TEM	0x8E			ReadWord	ACK	1	0x0018		
21:46.6	PMBus	1	27	TPS40422	READ_TEM	0x8E	0x01		READ	ACK	1	0x0018	24 C	24
21:46.6	SAA	1	27	TPS40422	STATUS_C	0x7E			ReadByte	ACK	1	0x80		
21:46.6	PMBus	1	27	TPS40422	STATUS_C	0x7E			READ	ACK	1	0x80	INVALID_CMD	
21:46.8	SAA	1	27	TPS40422	PAGE	0x00			WriteByte	ACK	1	0x00		

Figure 61. PMBus Log File

Evaluation Board/Kit Important Notice

Texas Instruments (TI) provides the enclosed product(s) under the following conditions:

This evaluation board/kit is intended for use for **ENGINEERING DEVELOPMENT, DEMONSTRATION, OR EVALUATION PURPOSES ONLY** and is not considered by TI to be a finished end-product fit for general consumer use. Persons handling the product(s) must have electronics training and observe good engineering practice standards. As such, the goods being provided are not intended to be complete in terms of required design-, marketing-, and/or manufacturing-related protective considerations, including product safety and environmental measures typically found in end products that incorporate such semiconductor components or circuit boards. This evaluation board/kit does not fall within the scope of the European Union directives regarding electromagnetic compatibility, restricted substances (RoHS), recycling (WEEE), FCC, CE or UL, and therefore may not meet the technical requirements of these directives or other related directives.

Should this evaluation board/kit not meet the specifications indicated in the User's Guide, the board/kit may be returned within 30 days from the date of delivery for a full refund. **THE FOREGOING WARRANTY IS THE EXCLUSIVE WARRANTY MADE BY SELLER TO BUYER AND IS IN LIEU OF ALL OTHER WARRANTIES, EXPRESSED, IMPLIED, OR STATUTORY, INCLUDING ANY WARRANTY OF MERCHANTABILITY OR FITNESS FOR ANY PARTICULAR PURPOSE.**

The user assumes all responsibility and liability for proper and safe handling of the goods. Further, the user indemnifies TI from all claims arising from the handling or use of the goods. Due to the open construction of the product, it is the user's responsibility to take any and all appropriate precautions with regard to electrostatic discharge.

EXCEPT TO THE EXTENT OF THE INDEMNITY SET FORTH ABOVE, NEITHER PARTY SHALL BE LIABLE TO THE OTHER FOR ANY INDIRECT, SPECIAL, INCIDENTAL, OR CONSEQUENTIAL DAMAGES.

TI currently deals with a variety of customers for products, and therefore our arrangement with the user **is not exclusive.**

TI assumes **no liability for applications assistance, customer product design, software performance, or infringement of patents or services described herein.**

Please read the User's Guide and, specifically, the Warnings and Restrictions notice in the User's Guide prior to handling the product. This notice contains important safety information about temperatures and voltages. For additional information on TI's environmental and/or safety programs, please contact the TI application engineer or visit www.ti.com/esh.

No license is granted under any patent right or other intellectual property right of TI covering or relating to any machine, process, or combination in which such TI products or services might be or are used.

FCC Warning

This evaluation board/kit is intended for use for **ENGINEERING DEVELOPMENT, DEMONSTRATION, OR EVALUATION PURPOSES ONLY** and is not considered by TI to be a finished end-product fit for general consumer use. It generates, uses, and can radiate radio frequency energy and has not been tested for compliance with the limits of computing devices pursuant to part 15 of FCC rules, which are designed to provide reasonable protection against radio frequency interference. Operation of this equipment in other environments may cause interference with radio communications, in which case the user at his own expense will be required to take whatever measures may be required to correct this interference.

EVM Warnings and Restrictions

It is important to operate this EVM within the input voltage range of 8 V to 14 V and the output voltage range of 1.2 V to 3.3 V .

Exceeding the specified input range may cause unexpected operation and/or irreversible damage to the EVM. If there are questions concerning the input range, please contact a TI field representative prior to connecting the input power.

Applying loads outside of the specified output range may result in unintended operation and/or possible permanent damage to the EVM. Please consult the EVM User's Guide prior to connecting any load to the EVM output. If there is uncertainty as to the load specification, please contact a TI field representative.

During normal operation, some circuit components may have case temperatures greater than 60° C. The EVM is designed to operate properly with certain components above 60° C as long as the input and output ranges are maintained. These components include but are not limited to linear regulators, switching transistors, pass transistors, and current sense resistors. These types of devices can be identified using the EVM schematic located in the EVM User's Guide. When placing measurement probes near these devices during operation, please be aware that these devices may be very warm to the touch.

Mailing Address: Texas Instruments, Post Office Box 655303, Dallas, Texas 75265
Copyright © 2012, Texas Instruments Incorporated

EVALUATION BOARD/KIT/MODULE (EVM) ADDITIONAL TERMS

Texas Instruments (TI) provides the enclosed Evaluation Board/Kit/Module (EVM) under the following conditions:

The user assumes all responsibility and liability for proper and safe handling of the goods. Further, the user indemnifies TI from all claims arising from the handling or use of the goods.

Should this evaluation board/kit not meet the specifications indicated in the User's Guide, the board/kit may be returned within 30 days from the date of delivery for a full refund. THE FOREGOING LIMITED WARRANTY IS THE EXCLUSIVE WARRANTY MADE BY SELLER TO BUYER AND IS IN LIEU OF ALL OTHER WARRANTIES, EXPRESSED, IMPLIED, OR STATUTORY, INCLUDING ANY WARRANTY OF MERCHANTABILITY OR FITNESS FOR ANY PARTICULAR PURPOSE. EXCEPT TO THE EXTENT OF THE INDEMNITY SET FORTH ABOVE, NEITHER PARTY SHALL BE LIABLE TO THE OTHER FOR ANY INDIRECT, SPECIAL, INCIDENTAL, OR CONSEQUENTIAL DAMAGES.

Please read the User's Guide and, specifically, the Warnings and Restrictions notice in the User's Guide prior to handling the product. This notice contains important safety information about temperatures and voltages. For additional information on TI's environmental and/or safety programs, please visit www.ti.com/esh or contact TI.

No license is granted under any patent right or other intellectual property right of TI covering or relating to any machine, process, or combination in which such TI products or services might be or are used. TI currently deals with a variety of customers for products, and therefore our arrangement with the user is not exclusive. TI assumes no liability for applications assistance, customer product design, software performance, or infringement of patents or services described herein.

REGULATORY COMPLIANCE INFORMATION

As noted in the EVM User's Guide and/or EVM itself, this EVM and/or accompanying hardware may or may not be subject to the Federal Communications Commission (FCC) and Industry Canada (IC) rules.

For EVMs **not** subject to the above rules, this evaluation board/kit/module is intended for use for ENGINEERING DEVELOPMENT, DEMONSTRATION OR EVALUATION PURPOSES ONLY and is not considered by TI to be a finished end product fit for general consumer use. It generates, uses, and can radiate radio frequency energy and has not been tested for compliance with the limits of computing devices pursuant to part 15 of FCC or ICES-003 rules, which are designed to provide reasonable protection against radio frequency interference. Operation of the equipment may cause interference with radio communications, in which case the user at his own expense will be required to take whatever measures may be required to correct this interference.

General Statement for EVMs including a radio

User Power/Frequency Use Obligations: This radio is intended for development/professional use only in legally allocated frequency and power limits. Any use of radio frequencies and/or power availability of this EVM and its development application(s) must comply with local laws governing radio spectrum allocation and power limits for this evaluation module. It is the user's sole responsibility to only operate this radio in legally acceptable frequency space and within legally mandated power limitations. Any exceptions to this are strictly prohibited and unauthorized by Texas Instruments unless user has obtained appropriate experimental/development licenses from local regulatory authorities, which is responsibility of user including its acceptable authorization.

For EVMs annotated as FCC – FEDERAL COMMUNICATIONS COMMISSION Part 15 Compliant

Caution

This device complies with part 15 of the FCC Rules. Operation is subject to the following two conditions: (1) This device may not cause harmful interference, and (2) this device must accept any interference received, including interference that may cause undesired operation.

Changes or modifications not expressly approved by the party responsible for compliance could void the user's authority to operate the equipment.

FCC Interference Statement for Class A EVM devices

This equipment has been tested and found to comply with the limits for a Class A digital device, pursuant to part 15 of the FCC Rules. These limits are designed to provide reasonable protection against harmful interference when the equipment is operated in a commercial environment. This equipment generates, uses, and can radiate radio frequency energy and, if not installed and used in accordance with the instruction manual, may cause harmful interference to radio communications. Operation of this equipment in a residential area is likely to cause harmful interference in which case the user will be required to correct the interference at his own expense.

FCC Interference Statement for Class B EVM devices

This equipment has been tested and found to comply with the limits for a Class B digital device, pursuant to part 15 of the FCC Rules. These limits are designed to provide reasonable protection against harmful interference in a residential installation. This equipment generates, uses and can radiate radio frequency energy and, if not installed and used in accordance with the instructions, may cause harmful interference to radio communications. However, there is no guarantee that interference will not occur in a particular installation. If this equipment does cause harmful interference to radio or television reception, which can be determined by turning the equipment off and on, the user is encouraged to try to correct the interference by one or more of the following measures:

- Reorient or relocate the receiving antenna.
- Increase the separation between the equipment and receiver.
- Connect the equipment into an outlet on a circuit different from that to which the receiver is connected.
- Consult the dealer or an experienced radio/TV technician for help.

For EVMs annotated as IC – INDUSTRY CANADA Compliant

This Class A or B digital apparatus complies with Canadian ICES-003.

Changes or modifications not expressly approved by the party responsible for compliance could void the user's authority to operate the equipment.

Concerning EVMs including radio transmitters

This device complies with Industry Canada licence-exempt RSS standard(s). Operation is subject to the following two conditions: (1) this device may not cause interference, and (2) this device must accept any interference, including interference that may cause undesired operation of the device.

Concerning EVMs including detachable antennas

Under Industry Canada regulations, this radio transmitter may only operate using an antenna of a type and maximum (or lesser) gain approved for the transmitter by Industry Canada. To reduce potential radio interference to other users, the antenna type and its gain should be so chosen that the equivalent isotropically radiated power (e.i.r.p.) is not more than that necessary for successful communication.

This radio transmitter has been approved by Industry Canada to operate with the antenna types listed in the user guide with the maximum permissible gain and required antenna impedance for each antenna type indicated. Antenna types not included in this list, having a gain greater than the maximum gain indicated for that type, are strictly prohibited for use with this device.

Cet appareil numérique de la classe A ou B est conforme à la norme NMB-003 du Canada.

Les changements ou les modifications pas expressément approuvés par la partie responsable de la conformité ont pu vider l'autorité de l'utilisateur pour actionner l'équipement.

Concernant les EVMs avec appareils radio

Le présent appareil est conforme aux CNR d'Industrie Canada applicables aux appareils radio exempts de licence. L'exploitation est autorisée aux deux conditions suivantes : (1) l'appareil ne doit pas produire de brouillage, et (2) l'utilisateur de l'appareil doit accepter tout brouillage radioélectrique subi, même si le brouillage est susceptible d'en compromettre le fonctionnement.

Concernant les EVMs avec antennes détachables

Conformément à la réglementation d'Industrie Canada, le présent émetteur radio peut fonctionner avec une antenne d'un type et d'un gain maximal (ou inférieur) approuvé pour l'émetteur par Industrie Canada. Dans le but de réduire les risques de brouillage radioélectrique à l'intention des autres utilisateurs, il faut choisir le type d'antenne et son gain de sorte que la puissance isotrope rayonnée équivalente (p.i.r.e.) ne dépasse pas l'intensité nécessaire à l'établissement d'une communication satisfaisante.

Le présent émetteur radio a été approuvé par Industrie Canada pour fonctionner avec les types d'antenne énumérés dans le manuel d'usage et ayant un gain admissible maximal et l'impédance requise pour chaque type d'antenne. Les types d'antenne non inclus dans cette liste, ou dont le gain est supérieur au gain maximal indiqué, sont strictement interdits pour l'exploitation de l'émetteur.

【Important Notice for Users of this Product in Japan】

This development kit is NOT certified as Confirming to Technical Regulations of Radio Law of Japan

If you use this product in Japan, you are required by Radio Law of Japan to follow the instructions below with respect to this product:

1. Use this product in a shielded room or any other test facility as defined in the notification #173 issued by Ministry of Internal Affairs and Communications on March 28, 2006, based on Sub-section 1.1 of Article 6 of the Ministry's Rule for Enforcement of Radio Law of Japan,
2. Use this product only after you obtained the license of Test Radio Station as provided in Radio Law of Japan with respect to this product, or
3. Use of this product only after you obtained the Technical Regulations Conformity Certification as provided in Radio Law of Japan with respect to this product. Also, please do not transfer this product, unless you give the same notice above to the transferee. Please note that if you could not follow the instructions above, you will be subject to penalties of Radio Law of Japan.

Texas Instruments Japan Limited
(address) 24-1, Nishi-Shinjuku 6 chome, Shinjuku-ku, Tokyo, Japan

<http://www.tij.co.jp>

【ご使用にあたっての注】

本開発キットは技術基準適合証明を受けておりません。

本製品のご使用に際しては、電波法遵守のため、以下のいずれかの措置を取っていただく必要がありますのでご注意ください。

1. 電波法施行規則第6条第1項第1号に基づく平成18年3月28日総務省告示第173号で定められた電波暗室等の試験設備でご使用いただく。
2. 実験局の免許を取得後ご使用いただく。
3. 技術基準適合証明を取得後ご使用いただく。

なお、本製品は、上記の「ご使用にあたっての注意」を譲渡先、移転先に通知しない限り、譲渡、移転できないものとします。

上記を遵守頂けない場合は、電波法の罰則が適用される可能性があることをご留意ください。

日本テキサス・インスツルメンツ株式会社
東京都新宿区西新宿6丁目24番1号
西新宿三井ビル

<http://www.tij.co.jp>

EVALUATION BOARD/KIT/MODULE (EVM) WARNINGS, RESTRICTIONS AND DISCLAIMERS

For Feasibility Evaluation Only, in Laboratory/Development Environments. Unless otherwise indicated, this EVM is not a finished electrical equipment and not intended for consumer use. It is intended solely for use for preliminary feasibility evaluation in laboratory/development environments by technically qualified electronics experts who are familiar with the dangers and application risks associated with handling electrical mechanical components, systems and subsystems. It should not be used as all or part of a finished end product.

Your Sole Responsibility and Risk. You acknowledge, represent and agree that:

1. You have unique knowledge concerning Federal, State and local regulatory requirements (including but not limited to Food and Drug Administration regulations, if applicable) which relate to your products and which relate to your use (and/or that of your employees, affiliates, contractors or designees) of the EVM for evaluation, testing and other purposes.
2. You have full and exclusive responsibility to assure the safety and compliance of your products with all such laws and other applicable regulatory requirements, and also to assure the safety of any activities to be conducted by you and/or your employees, affiliates, contractors or designees, using the EVM. Further, you are responsible to assure that any interfaces (electronic and/or mechanical) between the EVM and any human body are designed with suitable isolation and means to safely limit accessible leakage currents to minimize the risk of electrical shock hazard.
3. You will employ reasonable safeguards to ensure that your use of the EVM will not result in any property damage, injury or death, even if the EVM should fail to perform as described or expected.
4. You will take care of proper disposal and recycling of the EVM's electronic components and packing materials.

Certain Instructions. It is important to operate this EVM within TI's recommended specifications and environmental considerations per the user guidelines. Exceeding the specified EVM ratings (including but not limited to input and output voltage, current, power, and environmental ranges) may cause property damage, personal injury or death. If there are questions concerning these ratings please contact a TI field representative prior to connecting interface electronics including input power and intended loads. Any loads applied outside of the specified output range may result in unintended and/or inaccurate operation and/or possible permanent damage to the EVM and/or interface electronics. Please consult the EVM User's Guide prior to connecting any load to the EVM output. If there is uncertainty as to the load specification, please contact a TI field representative. During normal operation, some circuit components may have case temperatures greater than 60°C as long as the input and output are maintained at a normal ambient operating temperature. These components include but are not limited to linear regulators, switching transistors, pass transistors, and current sense resistors which can be identified using the EVM schematic located in the EVM User's Guide. When placing measurement probes near these devices during normal operation, please be aware that these devices may be very warm to the touch. As with all electronic evaluation tools, only qualified personnel knowledgeable in electronic measurement and diagnostics normally found in development environments should use these EVMs.

Agreement to Defend, Indemnify and Hold Harmless. You agree to defend, indemnify and hold TI, its licensors and their representatives harmless from and against any and all claims, damages, losses, expenses, costs and liabilities (collectively, "Claims") arising out of or in connection with any use of the EVM that is not in accordance with the terms of the agreement. This obligation shall apply whether Claims arise under law of tort or contract or any other legal theory, and even if the EVM fails to perform as described or expected.

Safety-Critical or Life-Critical Applications. If you intend to evaluate the components for possible use in safety critical applications (such as life support) where a failure of the TI product would reasonably be expected to cause severe personal injury or death, such as devices which are classified as FDA Class III or similar classification, then you must specifically notify TI of such intent and enter into a separate Assurance and Indemnity Agreement.

Mailing Address: Texas Instruments, Post Office Box 655303, Dallas, Texas 75265
Copyright © 2012, Texas Instruments Incorporated

IMPORTANT NOTICE

Texas Instruments Incorporated and its subsidiaries (TI) reserve the right to make corrections, enhancements, improvements and other changes to its semiconductor products and services per JESD46, latest issue, and to discontinue any product or service per JESD48, latest issue. Buyers should obtain the latest relevant information before placing orders and should verify that such information is current and complete. All semiconductor products (also referred to herein as "components") are sold subject to TI's terms and conditions of sale supplied at the time of order acknowledgment.

TI warrants performance of its components to the specifications applicable at the time of sale, in accordance with the warranty in TI's terms and conditions of sale of semiconductor products. Testing and other quality control techniques are used to the extent TI deems necessary to support this warranty. Except where mandated by applicable law, testing of all parameters of each component is not necessarily performed.

TI assumes no liability for applications assistance or the design of Buyers' products. Buyers are responsible for their products and applications using TI components. To minimize the risks associated with Buyers' products and applications, Buyers should provide adequate design and operating safeguards.

TI does not warrant or represent that any license, either express or implied, is granted under any patent right, copyright, mask work right, or other intellectual property right relating to any combination, machine, or process in which TI components or services are used. Information published by TI regarding third-party products or services does not constitute a license to use such products or services or a warranty or endorsement thereof. Use of such information may require a license from a third party under the patents or other intellectual property of the third party, or a license from TI under the patents or other intellectual property of TI.

Reproduction of significant portions of TI information in TI data books or data sheets is permissible only if reproduction is without alteration and is accompanied by all associated warranties, conditions, limitations, and notices. TI is not responsible or liable for such altered documentation. Information of third parties may be subject to additional restrictions.

Resale of TI components or services with statements different from or beyond the parameters stated by TI for that component or service voids all express and any implied warranties for the associated TI component or service and is an unfair and deceptive business practice. TI is not responsible or liable for any such statements.

Buyer acknowledges and agrees that it is solely responsible for compliance with all legal, regulatory and safety-related requirements concerning its products, and any use of TI components in its applications, notwithstanding any applications-related information or support that may be provided by TI. Buyer represents and agrees that it has all the necessary expertise to create and implement safeguards which anticipate dangerous consequences of failures, monitor failures and their consequences, lessen the likelihood of failures that might cause harm and take appropriate remedial actions. Buyer will fully indemnify TI and its representatives against any damages arising out of the use of any TI components in safety-critical applications.

In some cases, TI components may be promoted specifically to facilitate safety-related applications. With such components, TI's goal is to help enable customers to design and create their own end-product solutions that meet applicable functional safety standards and requirements. Nonetheless, such components are subject to these terms.

No TI components are authorized for use in FDA Class III (or similar life-critical medical equipment) unless authorized officers of the parties have executed a special agreement specifically governing such use.

Only those TI components which TI has specifically designated as military grade or "enhanced plastic" are designed and intended for use in military/aerospace applications or environments. Buyer acknowledges and agrees that any military or aerospace use of TI components which have **not** been so designated is solely at the Buyer's risk, and that Buyer is solely responsible for compliance with all legal and regulatory requirements in connection with such use.

TI has specifically designated certain components which meet ISO/TS16949 requirements, mainly for automotive use. Components which have not been so designated are neither designed nor intended for automotive use; and TI will not be responsible for any failure of such components to meet such requirements.

Products

Audio	www.ti.com/audio
Amplifiers	amplifier.ti.com
Data Converters	dataconverter.ti.com
DLP® Products	www.dlp.com
DSP	dsp.ti.com
Clocks and Timers	www.ti.com/clocks
Interface	interface.ti.com
Logic	logic.ti.com
Power Mgmt	power.ti.com
Microcontrollers	microcontroller.ti.com
RFID	www.ti-rfid.com
OMAP Applications Processors	www.ti.com/omap
Wireless Connectivity	www.ti.com/wirelessconnectivity

Applications

Automotive and Transportation	www.ti.com/automotive
Communications and Telecom	www.ti.com/communications
Computers and Peripherals	www.ti.com/computers
Consumer Electronics	www.ti.com/consumer-apps
Energy and Lighting	www.ti.com/energy
Industrial	www.ti.com/industrial
Medical	www.ti.com/medical
Security	www.ti.com/security
Space, Avionics and Defense	www.ti.com/space-avionics-defense
Video and Imaging	www.ti.com/video

TI E2E Community

e2e.ti.com