

Triple-Supply Power Management IC for Powering FPGAs and DSPs

Check for Samples: [TPS75003-EP](#)

FEATURES

- Two 95% Efficient, 3-A Buck Controllers and One 300-mA LDO
- Tested and Endorsed by Xilinx for Powering the Spartan™-3, Spartan-3E, and Spartan-3L FPGAs
- Adjustable (1.2 V to 6.5 V for Bucks, 1 V to 6.5 V for LDO) Output Voltages on All Channels
- Input Voltage Range: 2.2 V to 6.5 V
- Independent Soft-Start for Each Supply
- Independent Enable for Each Supply for Flexible Sequencing
- LDO Stable with 2.2- μ F Ceramic Output Capacitor
- Small, Low-Profile 4,5 mm x 3,5 mm x 0,9 mm QFN Package

SUPPORTS DEFENSE, AEROSPACE, AND MEDICAL APPLICATIONS

- Controlled Baseline
- One Assembly/Test Site
- One Fabrication Site
- Available in Military (–55°C/125°C) Temperature Range⁽¹⁾
- Extended Product Life Cycle
- Extended Product-Change Notification
- Product Traceability

(1) Additional temperature ranges available - contact factory

APPLICATIONS

- FPGA/DSP/ASIC Supplies
- Set-Top Boxes
- DSL Modems
- Plasma TV Display Panels

DESCRIPTION

The TPS75003 is a complete power management solution for FPGA, DSP and other multi-supply applications. The device has been tested with and meets all of the Xilinx Spartan-3, Spartan-3E, and Spartan-3L start-up profile requirements, including monotonic voltage ramp and minimum voltage rail rise time. Independent Enables for each output allow sequencing to minimize demand on the power supply at start-up. Soft-start on each supply limits inrush current during start-up. Two integrated buck controllers allow efficient, cost-effective voltage conversion for both low and high current supplies such as core and I/O. A 300-mA LDO is integrated to provide an auxiliary rail such as V_{CCAUX} on the Xilinx Spartan-3 FPGA. All three supply voltages are offered in user-programmable options for maximum flexibility.

The TPS75003 is fully specified from –55°C to +125°C and is offered in a QFN package, yielding a highly compact total solution size with high power dissipation capability.



Please be aware that an important notice concerning availability, standard warranty, and use in critical applications of Texas Instruments semiconductor products and disclaimers thereto appears at the end of this data sheet.

Spartan is a trademark of Xilinx, Inc.



These devices have limited built-in ESD protection. The leads should be shorted together or the device placed in conductive foam during storage or handling to prevent electrostatic damage to the MOS gates.

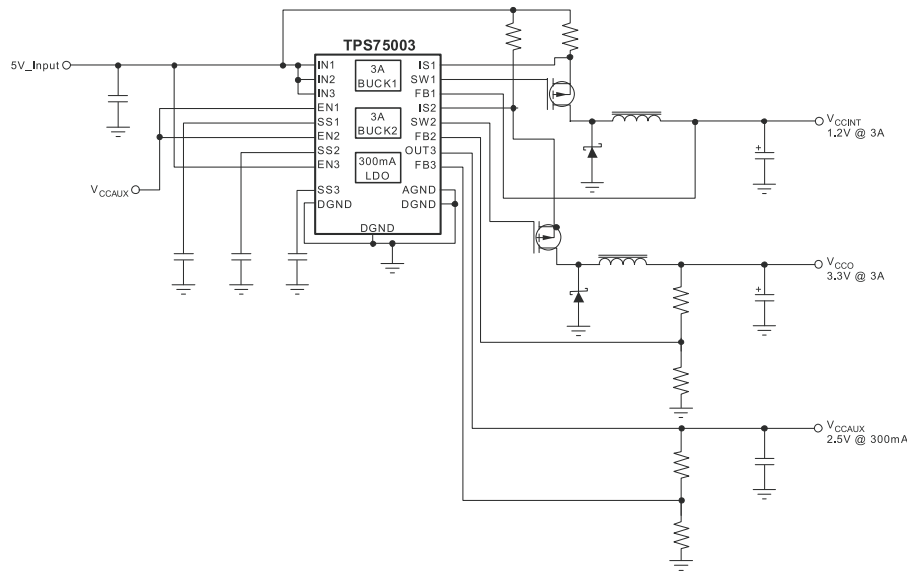

ORDERING INFORMATION⁽¹⁾

PRODUCT	V _{OUT}
TPS75003MRHLREP	Buck1: Adjustable Buck2: Adjustable LDO: Adjustable

(1) For the most current specifications and package information, see the Package Option Addendum located at the end of this document or see the Texas Instruments website at www.ti.com.

ABSOLUTE MAXIMUM RATINGS

over operating free-air temperature range (unless otherwise noted)⁽¹⁾

	TPS75003	UNIT
V _{INX} range (IN1, IN2, IN3)	-0.3 to +7	V
V _{ENX} range (EN1, EN2, EN3)	-0.3 to V _{INX} + 0.3	V
V _{SWX} range (SW1, SW2, SW3)	-0.3 to V _{INX} + 0.3	V
V _{ISX} range (IS1, IS2, IS3)	-0.3 to V _{INX} + 0.3	V
V _{OUT3} range	-0.3 to +7	V
V _{SSX} range (SS1, SS2, SS3)	-0.3 to V _{INX} + 0.3	V
V _{FBX} range (FB1, FB2, FB3)	-0.3 to +3.3	V
Peak LDO output current (I _{OUT3})	Internally limited	—
Continuous total power dissipation	See the Thermal Information Table	—
Junction temperature range, T _J	-55 to +150	°C
Storage temperature range	-65 to +150	°C
ESD rating, HBM	1	kV
ESD rating, CDM	500	V

(1) Stresses beyond those listed under absolute maximum ratings may cause permanent damage to the device. These are stress ratings only, and functional operation of the device at these or any other conditions beyond those indicated under the Electrical Characteristics is not implied. Exposure to absolute maximum rated conditions for extended periods may affect device reliability.

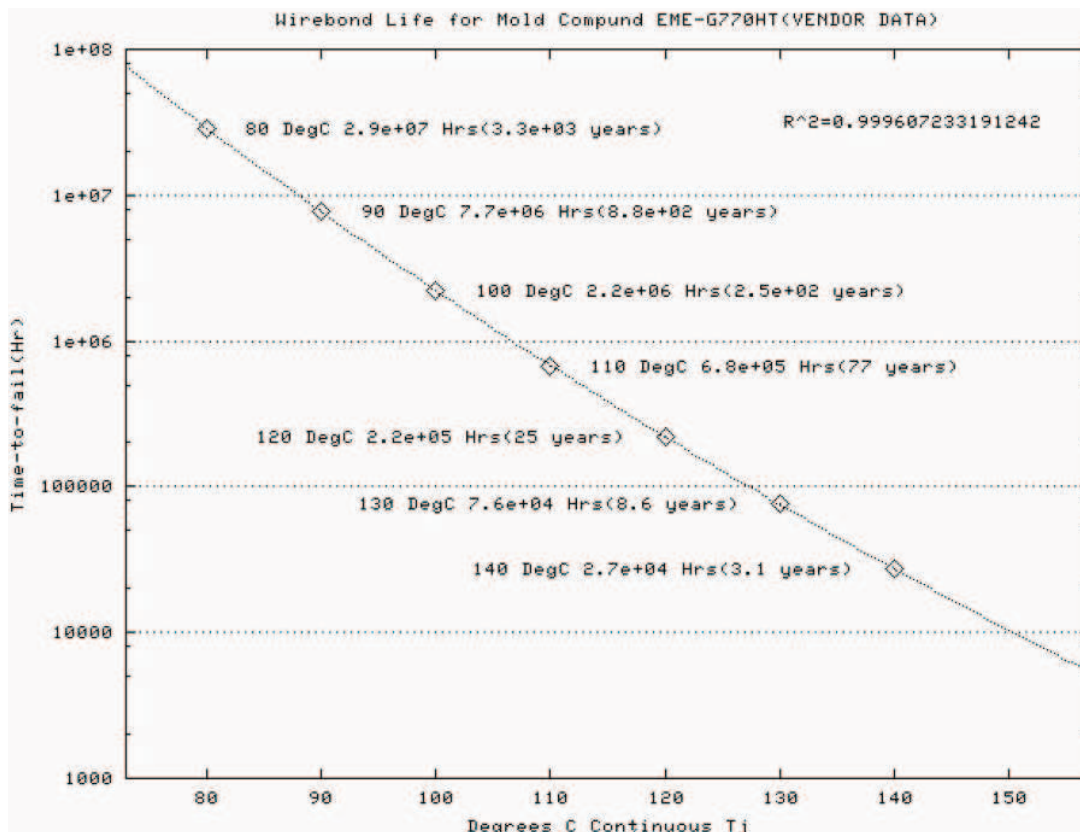

Figure 1. Wirebond Plot

THERMAL INFORMATION

THERMAL METRIC ⁽¹⁾		TPS75003-EP	UNITS
		RHL (20 PINS)	
θ_{JA}	Junction-to-ambient thermal resistance	42.6	°C/W
θ_{JCTop}	Junction-to-case (top) thermal resistance	51.8	
θ_{JB}	Junction-to-board thermal resistance	39.5	
Ψ_{JT}	Junction-to-top characterization parameter	0.6	
Ψ_{JB}	Junction-to-board characterization parameter	14.2	
θ_{JCbott}	Junction-to-case (bottom) thermal resistance	2.8	

(1) For more information about traditional and new thermal metrics, see the *IC Package Thermal Metrics* application report, [SPRA953](#).

ELECTRICAL CHARACTERISTICS

$V_{EN1} = V_{IN1}$, $V_{EN2} = V_{IN2}$, $V_{EN3} = V_{IN3}$, $V_{IN1} = V_{IN2} = 2.2\text{ V}$, $V_{IN3} = 3\text{ V}$, $V_{OUT3} = 2.5\text{ V}$, $C_{OUT1} = C_{OUT2} = 47\text{ }\mu\text{F}$, $C_{OUT3} = 2.2\text{ }\mu\text{F}$, $T_A = -55^\circ\text{C}$ to 125°C , unless otherwise noted. Typical values are at $T_A = 25^\circ\text{C}$.

PARAMETER		CONDITIONS	MIN	TYP	MAX	UNIT
Supply and Logic						
V_{INX}	Input voltage range (IN1, IN2, IN3) ⁽¹⁾		2.2		6.5	V
I_Q	Quiescent current, $I_Q = I_{DGND} + I_{AGND}$	$I_{OUT1} = I_{OUT2} = I_{OUT3} = 0\text{ mA}$		75	150	μA
I_{SHDN}	Shutdown supply current	$V_{EN1} = V_{EN2} = V_{EN3} = 0\text{ V}$		0.05	3	μA
$V_{IH1,2}$	Enable high, enabled (EN1, EN2)	$T_A = 25^\circ\text{C}$	1.4			V
		$T_A = \text{Full Range}$	1.45			
V_{IH3}	Enable High, enabled (EN3)	$T_A = 25^\circ\text{C}$	1.14			V
		$T_A = \text{Full Range}$	1.2			
V_{ILX}	Enable low, shutdown (EN1, EN2, EN3)		0		0.3	V
I_{ENX}	Enable pin current (EN1, EN2, EN3)			0.01	0.5	μA
Buck Controllers 1 and 2						
$V_{OUT1,2}$	Adjustable output voltage Range ⁽²⁾		V_{FBX}		V_{INX}	V
$V_{FB1,2}$	Feedback voltage (FB1, FB2)			1.22		V
	Feedback voltage accuracy ⁽¹⁾ (FB1, FB2)			$\pm 2\%$		
$I_{FB1,2}$	Current into FB1, FB2 pins			0.01	0.5	μA
$V_{IS1,2}$	Reference voltage for current sense	$T_A = 25^\circ\text{C}$	80	100	120	mV
		$T_A = \text{Full Range}$	75		125	
$I_{IS1,2}$	Current into IS1, IS2 pins			0.01	0.5	μA
$\Delta V_{OUT\%}/\Delta V_{IN}$	Line regulation ⁽¹⁾	Measured with the circuit in Figure 2 , $V_{OUT} + 0.5\text{ V} \leq V_{IN} \leq 6.5\text{ V}$		0.1		% / V
$\Delta V_{OUT\%}/\Delta I_{OUT}$	Load regulation	Measured with the circuit in Figure 2 , $30\text{ mA} \leq I_{OUT} \leq 2\text{ A}$		0.6		% / A
$\eta_{1,2}$	Efficiency ⁽³⁾	Measured with the circuit in Figure 2 , $I_{OUT} = 1\text{ A}$		94%		
$t_{STR1,2}$	Startup time ⁽³⁾	Measured with the circuit in Figure 2 , $R_L = 6\text{ }\Omega$, $C_{OUT} = 100\text{ }\mu\text{F}$, $C_{SS} = 2.2\text{ nF}$		5		ms
$R_{DS,ON1,2}$	Gate driver P-Channel and N-Channel MOSFET on-resistance	$V_{IN1,2} > 2.5\text{ V}$		4		Ω
		$V_{IN1,2} = 2.2\text{ V}$		6		
$I_{SW1,2}$	Gate Driver P-Channel and N-Channel MOSFET drive current			100		mA
t_{ON}	Minimum on time		1.36	1.55	1.84	μs
t_{OFF}	Minimum off time		0.44	0.65	0.86	μs

(1) To be in regulation, minimum V_{IN1} (or V_{IN2}) must be greater than $V_{OUT1,NOM}$ (or $V_{OUT2,NOM}$) by an amount determined by external components. Minimum $V_{IN3} = V_{OUT3} + V_{DO}$ or 2.2 V , whichever is greater.

(2) Maximum V_{OUT} is dependent on external components and will be less than V_{IN} . Parameter is not production tested.

(3) Depends on external components.

ELECTRICAL CHARACTERISTICS (continued)

$V_{EN1} = V_{IN1}$, $V_{EN2} = V_{IN2}$, $V_{EN3} = V_{IN3}$, $V_{IN1} = V_{IN2} = 2.2\text{ V}$, $V_{IN3} = 3\text{ V}$, $V_{OUT3} = 2.5\text{ V}$, $C_{OUT1} = C_{OUT2} = 47\text{ }\mu\text{F}$, $C_{OUT3} = 2.2\text{ }\mu\text{F}$,
 $T_A = -55^\circ\text{C}$ to 125°C , unless otherwise noted. Typical values are at $T_A = 25^\circ\text{C}$.

PARAMETER		CONDITIONS	MIN	TYP	MAX	UNIT
LDO						
V_{OUT3}	Output voltage range ⁽⁴⁾		1		$6.5 - V_{DO}$	V
V_{FB3}	Feedback pin voltage			0.507		V
	Feedback pin voltage accuracy ⁽⁵⁾	$2.95\text{ V} \leq V_{IN3} \leq 6.5\text{ V}$ $1\text{ mA} \leq I_{OUT3} \leq 300\text{ mA}$		$\pm 4\%$		
$\Delta V_{OUT\%}/\Delta V_{IN}$	Line regulation ⁽⁵⁾	$V_{OUT3} + 0.5\text{ V} \leq V_{IN3} \leq 6.5\text{ V}$		0.075		% / V
$\Delta V_{OUT\%}/\Delta I_{OUT}$	Load regulation	$10\text{ mA} \leq I_{OUT3} \leq 300\text{ mA}$		0.01		% / mA
V_{DO}	Dropout voltage ($V_{IN} = V_{OUT(NOM)} - 0.1$) ⁽⁶⁾	$I_{OUT3} = 300\text{ mA}$		250	350	mV
I_{CL3}	Current limit	$V_{OUT} = 0.9 \times V_{OUT(NOM)}$	375	600	1000	mA
I_{FB3}	Current into FB3 pin			0.03	0.1	μA
V_n	Output noise	BW = 100 Hz - 100 kHz, $I_{OUT3} = 300\text{ mA}$		400		μV_{RMS}
t_{SD}	Thermal shutdown temperature for LDO	Shutdown, temperature increasing		175		$^\circ\text{C}$
		Reset, temperature decreasing		160		
UVLO	Undervoltage lockout threshold	V_{IN} rising		1.8		V
	Undervoltage lockout hysteresis	V_{IN} falling		100		mV

(4) Maximum V_{OUT} is dependent on external components and will be less than V_{IN} . Parameter is not production tested.

(5) To be in regulation, minimum V_{IN1} (or V_{IN2}) must be greater than $V_{OUT1,NOM}$ (or $V_{OUT2,NOM}$) by an amount determined by external components. Minimum $V_{IN3} = V_{OUT3} + V_{DO}$ or 2.2 V, whichever is greater.

(6) V_{DO} does not apply when $V_{OUT} + V_{DO} < 2.2\text{ V}$.

DEVICE INFORMATION

Functional Block Diagram

TPS75003

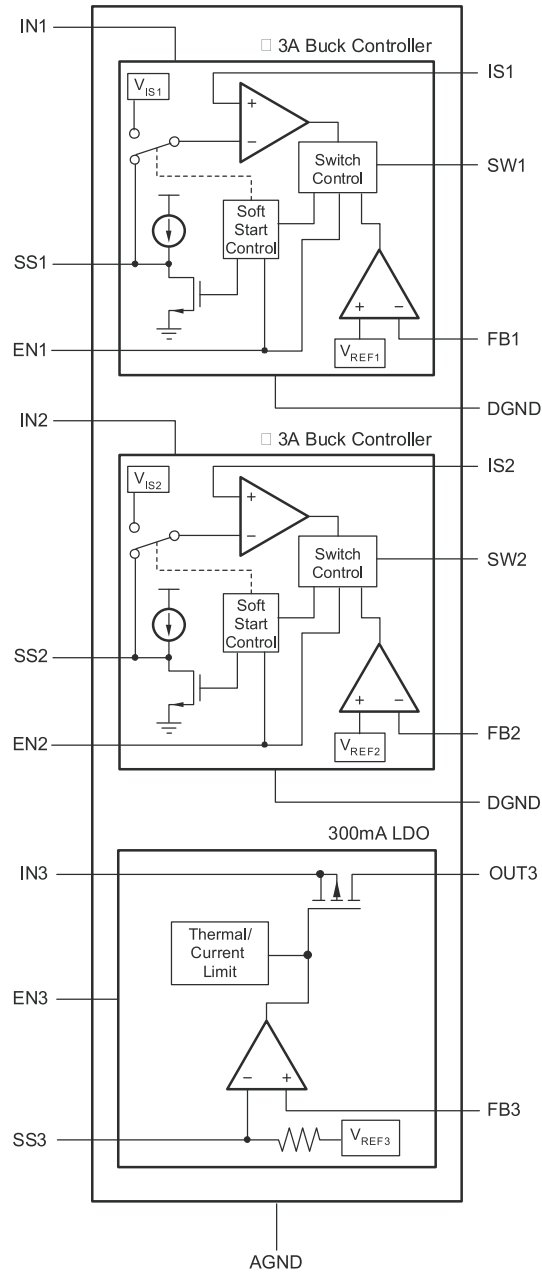

**RHL PACKAGE
4.5mm x 3.5mm QFN
(TOP VIEW)**

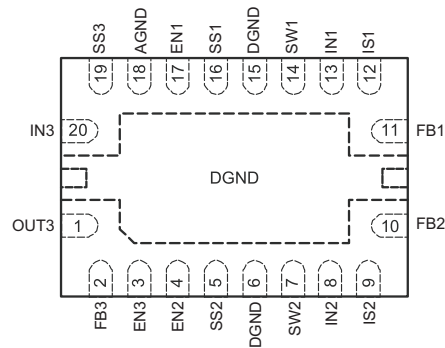

PIN FUNCTIONS

PIN		DESCRIPTION
NAME	RHL	
DGND	6, 15, PAD	Ground connection for BUCK1 and BUCK2 converters. Pins 6 and 15 should be connected to the back side exposed pad by a short metal trace as shown in the <i>PCB Layout</i> section of this data sheet.
AGND	18	Ground connection for LDO
IN1	13	Input supply to BUCK1
IN2	8	Input supply to BUCK2
IN3	20	Input supply to LDO
EN1	17	Driving the enable pin (ENx) high turns on BUCK1 regulator. Driving this pin low puts it into shutdown mode, reducing operating current. The enable pin does not trigger on fast negative going transients.
EN2	4	Same as EN1 but for BUCK2 controller
EN3	3	Same as EN1 but for LDO
SS1	16	Connecting a capacitor between this pin and ground increases start-up time of the BUCK1 regulator by slowing the ramp-up of current limit. This high-impedance pin is noise-sensitive; careful layout is important. See the <i>Typical Characteristics, Applications, and PCB Layout</i> sections for details.
SS2	5	Same as SS1 but for BUCK2 regulator.
SS3	19	Connecting a capacitor from this pin to ground slows the start-up time of the LDO reference, thereby slowing output voltage ramp-up. See the <i>Applications</i> section for details.
IS1	12	Current sense input for BUCK1 regulator. The voltage difference between this pin and IN1 is compared to an internal reference to set current limit. For a robust output start-up ramp, careful layout and bypassing are required. See the <i>Applications</i> section for details.
IS2	9	Same as IS1, but compared to IN2 and used for BUCK2 controller
SW1	14	Gate drive pin for external BUCK1 P-channel MOSFET
SW2	7	Same as SW1, but for BUCK2 controller
FB1	11	Feedback pin. Used to set the output voltage of BUCK1 regulator
FB2	10	Same as FB1, but for BUCK2 controller
FB3	2	Same as FB1, but for LDO
OUT3	1	Regulated LDO output. A small ceramic capacitor ($\geq 2.2 \mu\text{F}$) is needed from this pin to ground to ensure stability.

Typical Application Circuit for Powering the Xilinx Spartan-3 FPGA

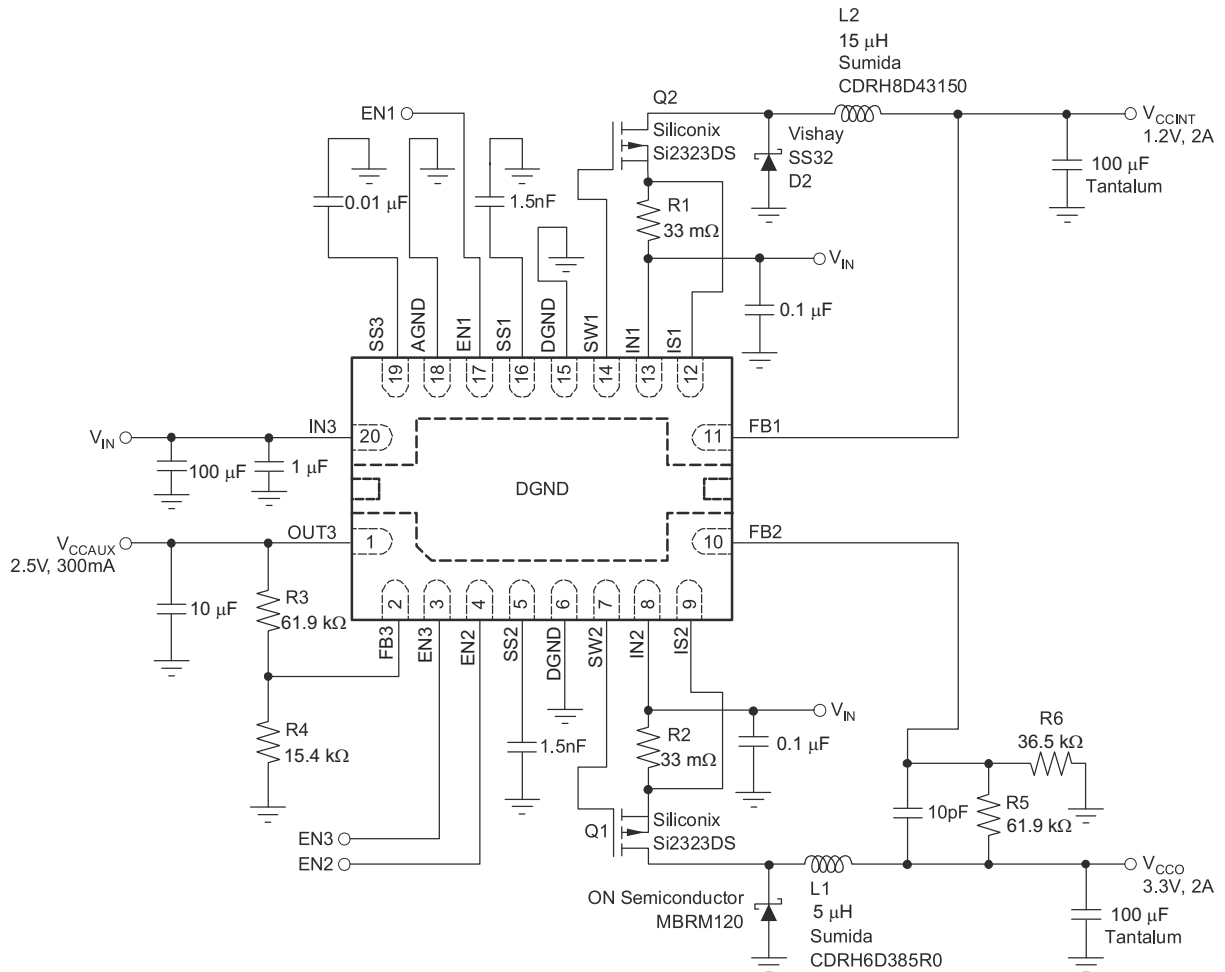

Figure 2.

TYPICAL CHARACTERISTICS

Measured using circuit in Figure 2

Buck Converter

BUCK LOAD REGULATION

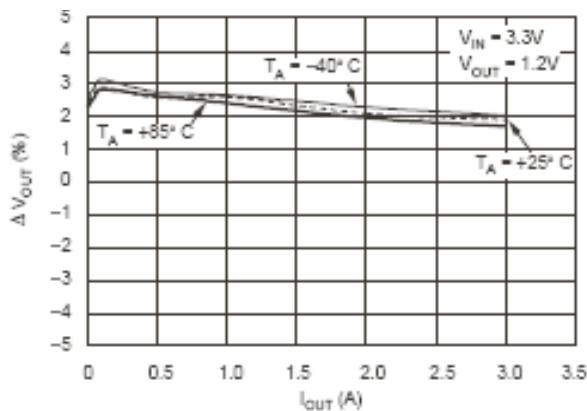

Figure 3.

BUCK LOAD REGULATION

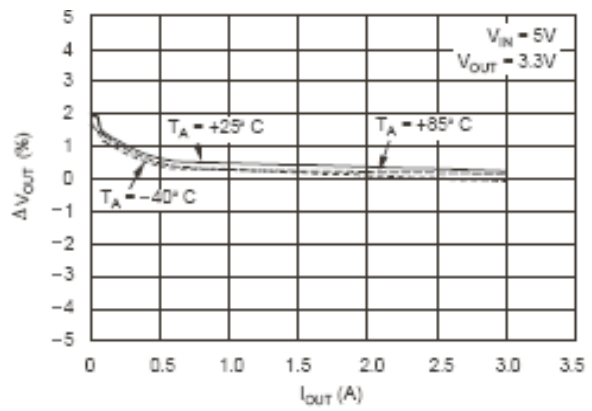

Figure 4.

TYPICAL CHARACTERISTICS (continued)

Measured using circuit in Figure 2

BUCK LINE REGULATION

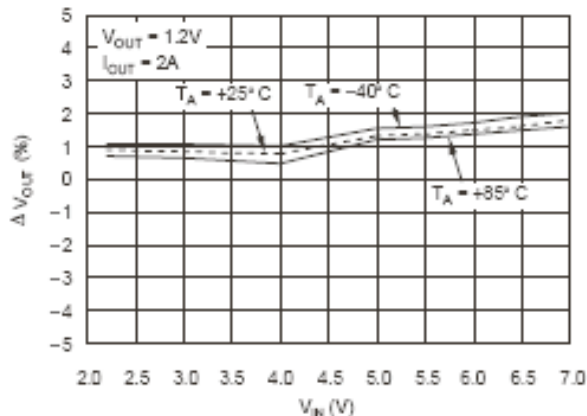

Figure 5.

BUCK LINE REGULATION

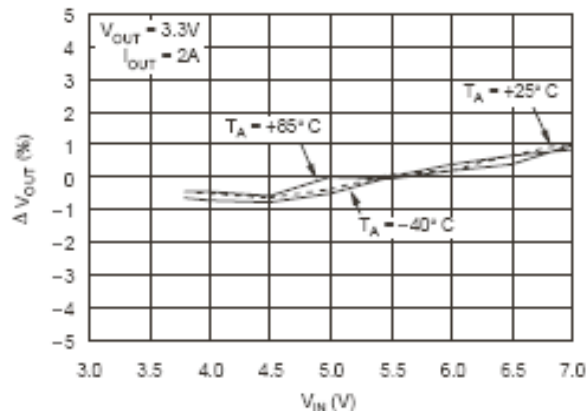

Figure 6.

BUCK SWITCHING FREQUENCY vs Iout, Ta

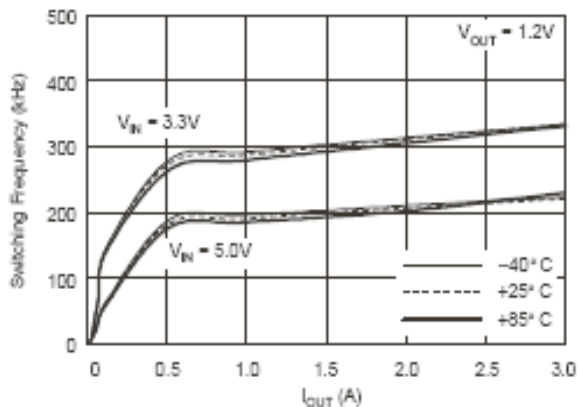

Figure 7.

BUCK SWITCHING FREQUENCY vs Iout

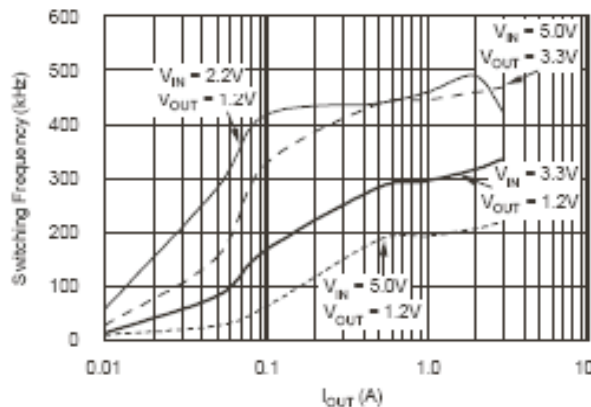

Figure 8.

BUCK OUTPUT VOLTAGE RIPPLE

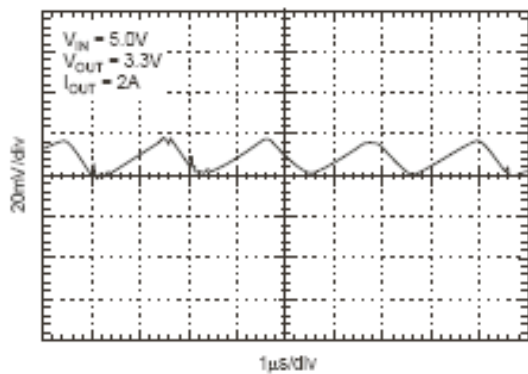

Figure 9.

EFFICIENCY vs Iout

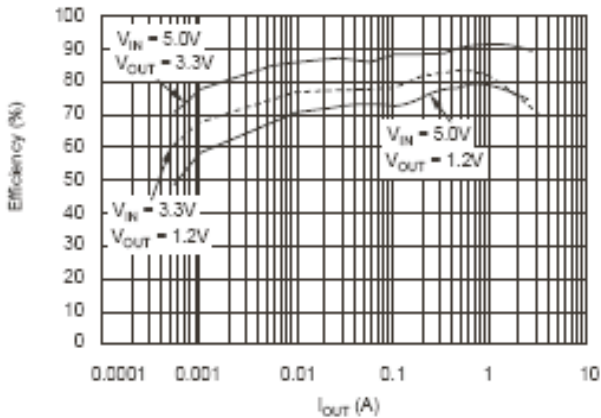

Figure 10.

TYPICAL CHARACTERISTICS (continued)

Measured using circuit in [Figure 2](#)

**BUCK START-UP
vs
 V_{IN} and I_{OUT}**

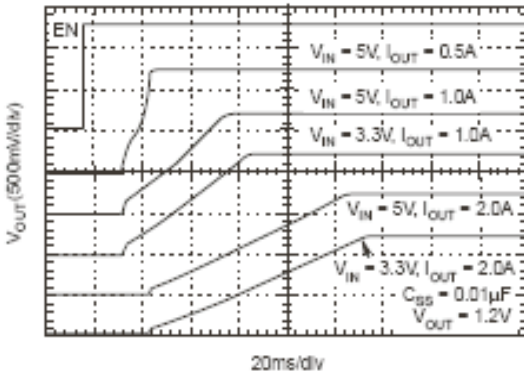

Figure 11.

**BUCK START-UP
vs
 V_{IN} and C_{OUT}**

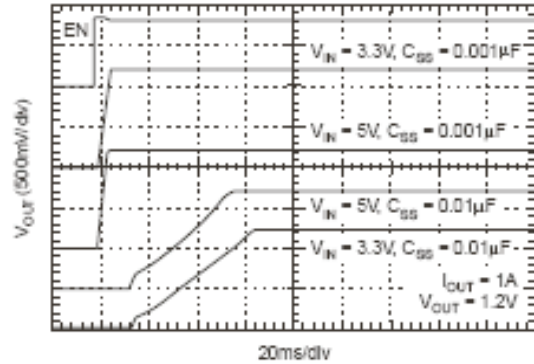

Figure 12.

**BUCK START-UP
vs
 V_{IN} and C_{SS}**

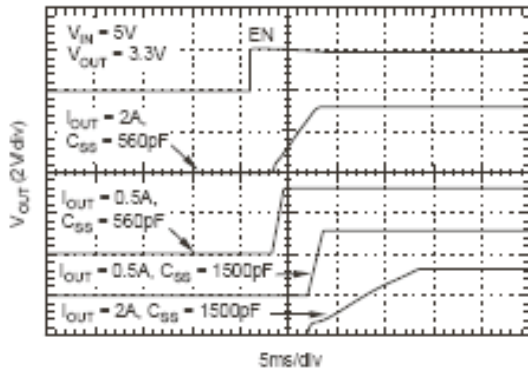

Figure 13.

**BUCK START-UP
vs
 I_{OUT} and C_{SS}**

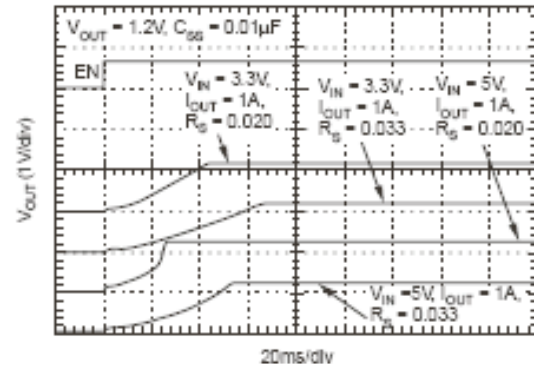

Figure 14.

LDO Converter

LDO LOAD REGULATION

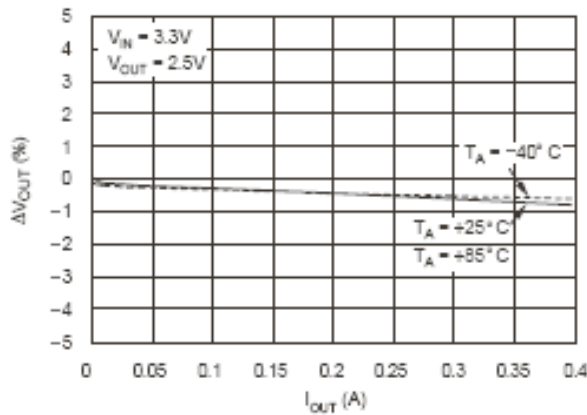

Figure 15.

LDO LINE REGULATION

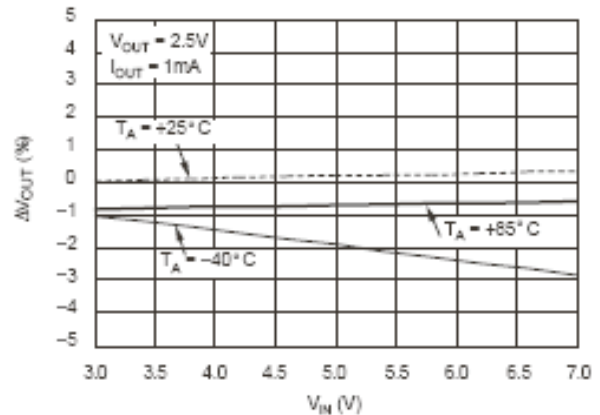

Figure 16.

TYPICAL CHARACTERISTICS (continued)

Measured using circuit in Figure 2

LDO DROPOUT vs I_{OUT}

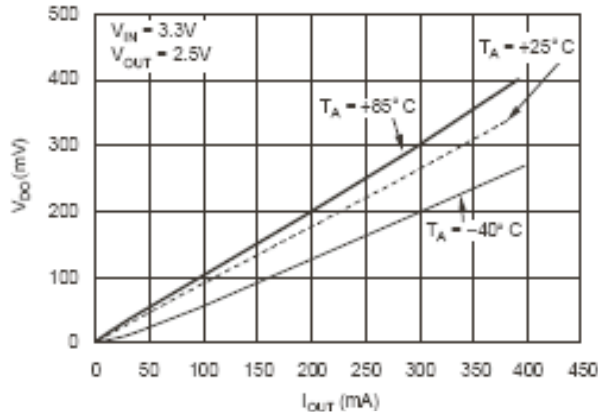

Figure 17.

LDO DROPOUT vs T_A

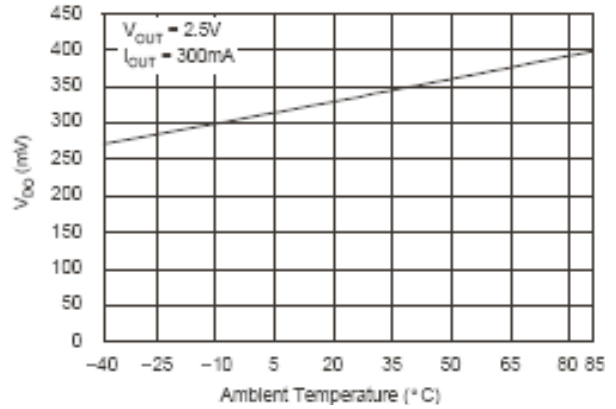

Figure 18.

$R_{DS,ON}$ PMOS vs V_{IN}

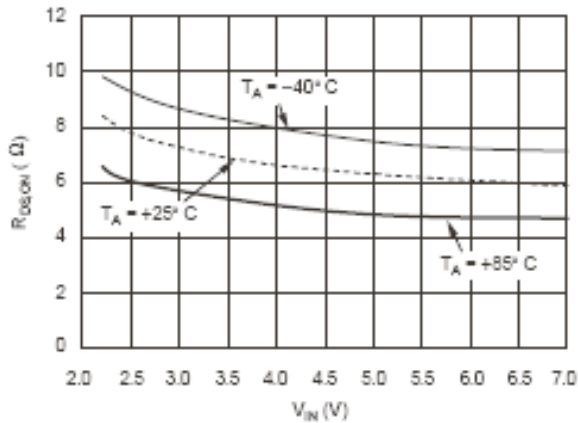

Figure 19.

$R_{DS,ON}$ NMOS vs V_{IN}

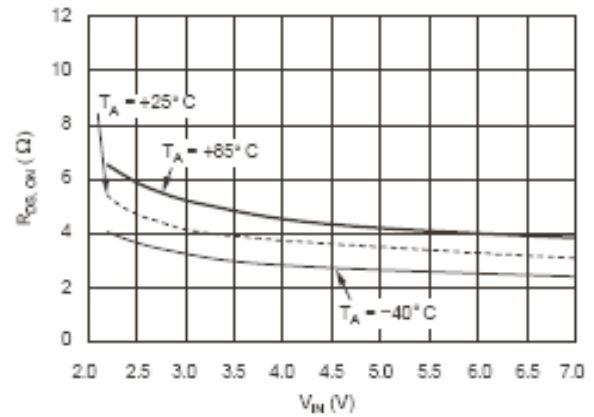

Figure 20.

LDO V_{OUT} vs T_A

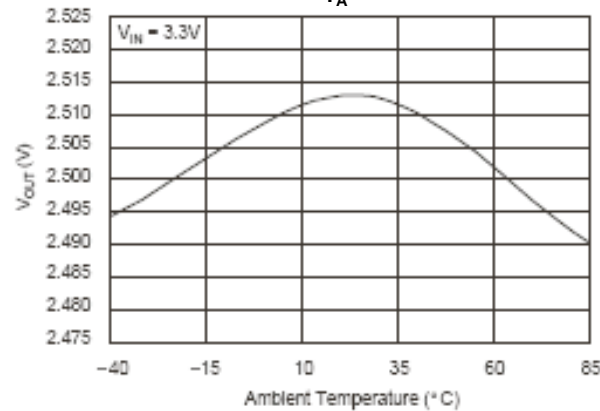

Figure 21.

APPLICATION INFORMATION

The TPS75003 is an integrated power management IC designed specifically to power DSPs and FPGAs such as the Xilinx Spartan-3, Spartan-3E and Spartan-3L. Two non-synchronous buck controllers can be configured to supply up to 3 A for both CORE and I/O rails. A low dropout linear regulator powers auxiliary rails up to 300 mA. All channels have independent enable and soft-start, allowing control of inrush current and output voltage ramp time as required by the application.

Figure 2 shows a typical application circuit for powering the Xilinx Spartan-3 FPGA. Table 1 through Table 4 show component values that have been tested for use with 2-A and 3-A load currents. Other similar external components can be substituted as desired; however, in all cases the circuits that are used should be tested for compliance to application requirements.

Table 1. Inductors Tested with the TPS75003

PART NUMBER	MANUFACTURER	INDUCTANCE	DC RESISTANCE	SATURATION CURRENT
SLF7032T-100M1R4	TDK	10 μ H \pm 20%	53 m Ω \pm 20%	1.4 A
SLF6025-150MR88	TDK	15 μ H \pm 20%	85 m Ω \pm 20%	0.88 A
CDRH6D28-5R0	Sumida	5 μ H	23 m Ω	2.4 A
CDRH6D38-5R0	Sumida	5 μ H	18 m Ω	2.9 A
CDRH103R-100	Sumida	10 μ H	45 m Ω	2.4 A
CDRH4D28-100	Sumida	10 μ H	96 m Ω	1 A
CDRH8D43-150	Sumida	15 μ H	42 m Ω	2.9 A
CDRH5D18-6R2	Sumida	6.2 μ H	71 m Ω	1.4 A
DO3316P-472	Coilcraft	4.7 μ H	18 m Ω	5.4 A
DT3316P-153	Coilcraft	15 μ H	60 m Ω	1.8 A
DT3316P-223	Coilcraft	22 μ H	84 m Ω	1.5 A
744052006	Würth	6.2 μ H	80 m Ω	1.45 A
74451115	Würth	15 μ H	90 m Ω	0.8 A

Table 2. PMOS Transistors Tested with the TPS75003

PART NUMBER	MANUFACTURER	R _{DS,ON} (TYP)	V _{DS}	I _D	PACKAGE
Si5447DC	Vishay Siliconix	0.11 Ω at VGS = -2.5 V	-20 V	-3.5 A at +25°C	1206
Si5475DC	Vishay Siliconix	0.041 Ω at VGS = -2.5 V	-12 V	-6.6 A at +25°C	1206
Si2323DS	Vishay Siliconix	0.052 Ω at VGS = -2.5 V	-20 V	-4.1 A at +25°C	SOT23
Si2301ADS	Vishay Siliconix	0.19 Ω at VGS = -2.5 V	-20 V	-1.4 A at +25°C	SOT23
Si2323DS	Vishay Siliconix	0.41 Ω at VGS = -2.5 V	-20 V	-4.1 A at +25°C	SOT23
FDG326P	Fairchild	0.17 Ω at VGS = -2.5 V	-20 V	-1.5 A	SC70

Table 3. Diodes Tested with the TPS75003

PART NUMBER	MANUFACTURER	V _R	I _F	PACKAGE
MBRM120LT3	ON Semiconductor	20 V	1 A	DO216AA
MBR0530T1	ON Semiconductor	30 V	1.5 A	SOD123
ZHCS2000TA	Zetex	40 V	2 A	SOT23-6
B320	Diodes Inc.	20 V	3 A	SMA
SS32	Fairchild	20 V	3 A	DO214AB

Table 4. Capacitors Tested with the TPS75003

PART NUMBER	MANUFACTURER	CAPACITANCE	ESR	VOLTAGE RATING
6TPB47M (PosCap)	Sanyo	47 μ F	0.1 Ω	6.3 V
T491D476M010AS	Kemet	47 μ F	0.8 Ω	10 V
B45197A	Epco	47 μ F	0.175 Ω	16 V
B45294-R1107-M40	Epco	100 μ F	0.045 Ω	6.3 V
594D476X0016C2	Vishay	47 μ F	0.11 Ω	16 V
594D127X96R3C2	Vishay	120 μ F	0.085 Ω	6.3 V
TPSC107K006R0150	AVX	100 μ F	0.15 Ω	6.3 V
6TPS100MC	Sanyo	100 μ F	0.45 Ω	6.3 V

OPERATION (BUCK CONTROLLERS)

Channels 1 and 2 contain two identical non-synchronous buck controllers that use minimum on-time/minimum off-time hysteric control. (See [Figure 2.](#)) For clarity, BUCK1 is used throughout the discussion of device operation. When V_{OUT1} is below its target, an external PMOS (Q1) is turned on for at least the minimum on-time, increasing current through the inductor (L1) until V_{OUT1} reaches its target value or the current limit (set by R1) is reached. Once either of these conditions is met, the PMOS is switched off for at least the minimum off-time of the device. After the minimum off-time has passed, the output voltage is monitored and the switch is turned on again when necessary.

When output current is low, the buck controllers operate in discontinuous mode. In this mode, each switching cycle begins at zero inductor current, rises to a maximum value, then falls back to zero current. When current reaches zero on the falling edge, ringing occurs at the resonant frequency of the inductor and stray switch node capacitance. This is normal operation; it does not affect circuit performance, and can be minimized if desired by using an RC snubber and/or a resistor in series with the gate of the PMOS, as shown in [Figure 22.](#)

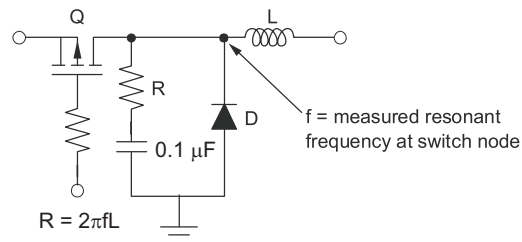
Figure 22. RC Snubber and Series Gate Resistor Used to Minimize Ringing

At higher output currents, the TPS75003 operates in continuous mode. In continuous mode, there is no ringing at the switch node and V_{OUT} is equal to V_{IN} times the duty cycle of the switching waveform.

When V_{IN} approaches or falls below V_{OUT} , the buck controllers operate in 100% duty cycle mode, fully turning on the external PMOS to allow regulation at lower dropout than would otherwise be possible.

Enable (Buck Controllers)

The enable pins (EN1 and EN2) for the buck controllers are active high. When the enable pin is driven low and input voltage is present at IN1 or IN2, an on-chip FET is turned on to discharge the soft-start pin SS1 or SS2, respectively. If the soft-start feature is being used, enable should be driven high at least 10 μ s after V_{IN} is applied to ensure this discharge cycle occurs.

UVLO (Buck Controllers)

An under-voltage lockout circuit is present to prevent turning on the external PMOS (Q1 or Q2) until a reliable operating voltage is reached on the appropriate regulator (IN1 or IN2). This prevents the buck controllers from mis-operation at low input voltages.

Current Limit (Buck Controllers)

An external resistor (R1 or R2) is used to set the current limit for the external PMOS transistor (Q1 or Q2). These resistors are connected between IN1 and IS1 (or IN2 and IS2) to provide a reference voltage across these pins that is proportional to the current flowing through the PMOS transistor. This reference voltage is compared to an internal reference to determine if an over-current condition exists. When current limit is exceeded, the external PMOS is turned off for the minimum off-time. Current limit detection is disabled for 10 ns any time the PMOS is turned on to avoid triggering on switching noise. In 100% duty cycle mode, current limit is always enabled. Current limit is calculated using the V_{IS1} or V_{IS2} specification in the *Electrical Characteristics* section, shown in [Equation 1](#).

$$I_{LIMIT} = \frac{V_{IS1,2}}{R_{1,2}} \quad (1)$$

The current limit resistor must be appropriately rated for the dissipated power determined by its RMS current calculated by [Equation 2](#).

$$I_{RMS} = I_{OUT} \sqrt{D} = I_{OUT} \sqrt{\frac{V_{OUT}}{V_{IN}}}$$

$$P_{DISS} = (I_{RMS})^2 \times R \quad (2)$$

For low-cost applications the $I_{S1,2}$ pin can be connected to the drain of the PMOS, using $R_{DS,ON}$ instead of R1 or R2 to set current limit. Variations in the PMOS $R_{DS,ON}$ must be taken into account to ensure that current limit will protect external components such as the inductor, the diode, and the switch itself from damage as a result of overcurrent.

Short-Circuit Protection (Buck Controllers)

In an overload condition, the current rating of the external components (PMOS, diode, and inductor) can be exceeded. To help guard against this, the TPS75003 increases its minimum off-time when the voltage at the feedback pin is lower than the reference voltage. When the output is shorted (V_{FB} is zero), minimum off-time is increased to approximately 4 μ s. The increase in off-time is proportional to the difference between the voltage at the feedback pin and the internal reference.

Soft-Start (Buck Controllers)

The buck controllers each have independent soft-start capability to limit inrush during start-up and to meet timing requirements of the Xilinx Spartan-3 FPGA. Limiting inrush current by using soft-start, or by staggering the turn-on of power rails, also guards against voltage drops at the input source due to its output impedance. See the soft-start circuitry shown in [Figure 23](#) and the soft-start timing diagram shown in [Figure 24](#). BUCK 1 will be discussed in this section; it is identical to BUCK2. Note that pins SS1 and SS2 are high-impedance and cannot be probed using a typical oscilloscope setup. When input voltage is applied at IN1 and EN1 is driven low, any charge on the SS pin is discharged by an on-chip pulldown transistor. When EN1 is driven high, an on-chip current source starts charging the external soft-start capacitor C_{SS1} . The voltage on the capacitor is compared to the voltage across the current sense resistor R1 to determine if an over-current condition exists. If the voltage drop across the sense resistor goes above the reference voltage, then the external PMOS is shut off for the minimum off-time. This implementation provides a cycle-by-cycle current limit and allows the user to program the soft-start time over a wide range for most applications. For detailed information on choosing C_{SS1} and C_{SS2} , see the section, *Selecting the Soft-Start Cap*.

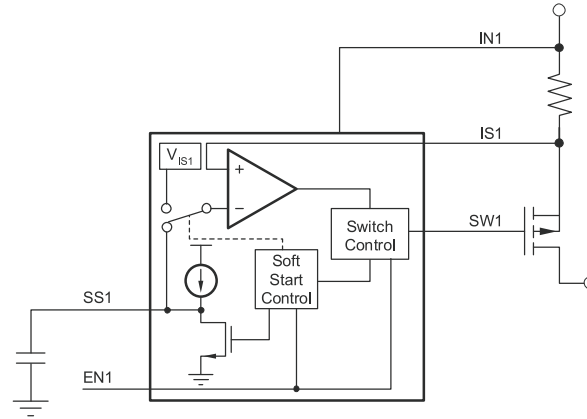

Figure 23. Soft-Start Circuitry

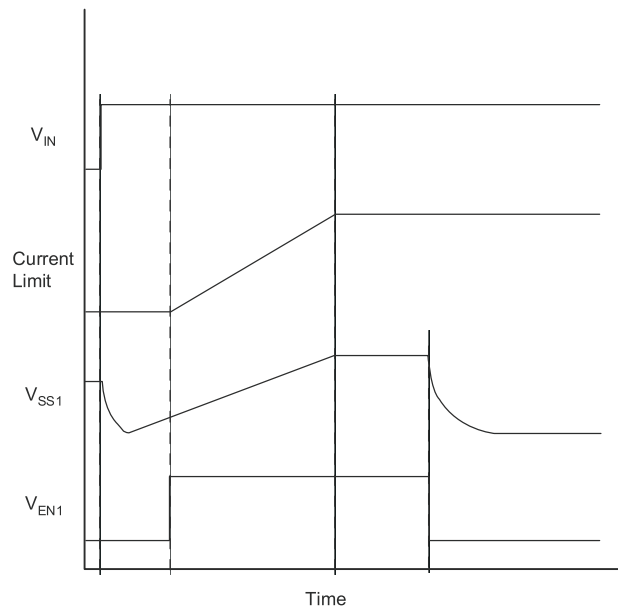

Figure 24. Soft-Start Timing Diagram

Input Capacitor C_{IN1} , C_{IN2} Selection (Buck Controllers)

It is good analog design practice to place input capacitors near the inputs of the device in order to ensure a low impedance input supply. A capacitance of 10 μF to 22 μF for each buck converter is adequate for most applications, and should be placed within 100 mils (0.001 in) of the IN1 and IN2 pins to minimize the effects of pulsed current switching noise on the soft-start circuitry during the first ~1 V of output voltage ramp. Low ESR capacitors also help to minimize noise on the supply line. The minimum value of capacitance can be estimated using Equation 3.

$$C_{IN, MIN} = \frac{(1/2)L \times (\Delta I_L)^2}{V_{RIPPLE} \times V_{IN}} \approx \frac{(1/2)L \times (0.3 \times I_{OUT})^2}{V_{RIPPLE} \times V_{IN}} \quad (3)$$

Note that the capacitors must be able to handle the RMS current in continuous conduction mode, which can be calculated using Equation 4.

$$I_{C,IN(RMS)} \approx \sqrt{\left(\frac{V_{OUT}}{V_{IN,MIN}}\right)} \quad (4)$$

Inductor Value Selection (Buck Controllers)

The inductor is chosen based on inductance value and maximum current rating. Larger inductors reduce current ripple (and therefore, output voltage ripple) but are physically larger and more expensive. Inductors with lower DC resistance typically improve efficiency, but also have higher cost and larger physical size. The buck converters work well with inductor values between 4.7 μH and 47 μH in most applications. When selecting an inductor, the current rating should exceed the current limit set by R_{IS} or $R_{\text{DS,ON}}$ (see *Current Limit* section). To determine the minimum inductor size, first determine if the device will operate in minimum on-time or minimum off-time mode. The device will operate in minimum on-time mode if [Equation 5](#) is satisfied.

$$V_{\text{IN}} - V_{\text{OUT}} - I_{\text{OUT}} \times r_{\text{DS(on)}} - R_{\text{L}} \times I_{\text{OUT}} \geq \frac{t_{\text{(OFF,min)}} \times (V_{\text{OUT}} + V_{\text{SCHOTTKY}} + R_{\text{L}} \times I_{\text{OUT}})}{t_{\text{ON,MIN}}} \quad (5)$$

where R_{L} = the inductor's DC resistance.

Minimum inductor size needed when operating in minimum on-time mode is given by [Equation 6](#).

$$L_{\text{MIN}} = \frac{(V_{\text{IN}} - V_{\text{OUT}} - I_{\text{OUT}} \times r_{\text{DS(on)}} - R_{\text{L}} \times I_{\text{OUT}}) \times t_{\text{ON,MIN}}}{\Delta I} \quad (6)$$

Minimum inductor size needed when operating in minimum off-time mode is given by [Equation 7](#).

$$L_{\text{MIN}} = \frac{(V_{\text{OUT}} + V_{\text{SCHOTTKY}} + R_{\text{L}} \times I_{\text{OUT}}) \times t_{\text{OFF,MIN}}}{\Delta I} \quad (7)$$

External PMOS Transistor Selection (Buck Controllers)

The external PMOS transistor is selected based on threshold voltage (V_{T}), on-resistance ($R_{\text{DS,ON}}$), gate capacitance (C_{G}) and voltage rating. The PMOS V_{T} magnitude must be much lower than the lowest voltage at IN1 or IN2 that will be used. A V_{T} magnitude that is 0.5 V less than the lowest input voltage is normally sufficient. The PMOS gate will see voltages from 0 V to the maximum input voltage, so gate-to-source breakdown should be a few volts higher than the maximum input supply. The drain-to-source of the device will also see this full voltage swing, and should therefore be a few volts higher than the maximum input supply. The RMS current in the PMOS can be estimated by using [Equation 8](#).

$$I_{\text{PMOS(RMS)}} \approx I_{\text{OUT}} \sqrt{D} = I_{\text{OUT}} \sqrt{\frac{V_{\text{OUT}}}{V_{\text{IN}}}} \quad (8)$$

The power dissipated in the PMOS is comprised of both conduction and switching losses. Switching losses are typically insignificant. The conduction losses are a function of the RMS current and the $R_{\text{DS,ON}}$ of the PMOS, and are calculated by [Equation 9](#).

$$P_{\text{(cond)}} = (I_{\text{OUT}} \sqrt{D})^2 \times r_{\text{DS(on)}} \times (1 + \text{TC} \times [T_{\text{J}} - 25^{\circ}\text{C}]) \approx (I_{\text{OUT}} \sqrt{D}) \times r_{\text{DS(on)}} \quad (9)$$

Diode Selection (Buck Controllers)

The diode is off when the PMOS is on, and on when the PMOS is off. Since it will be turned on and off at a relatively high frequency, a Schottky diode is recommended for good performance. The peak current rating of the diode should exceed the peak current limit set by the sense resistor $R_{IS1,2}$. A diode with low reverse leakage current and low forward voltage at operating current will optimize efficiency. Equation 10 calculates the estimated average power dissipation.

$$I_{(\text{diode})(\text{RMS})} \approx I_{\text{OUT}}(1 - D) = I_{\text{OUT}} \left(1 - \frac{V_{\text{OUT}}}{V_{\text{IN}}} \right) \quad (10)$$

Output Capacitor Selection (Buck Controllers)

The output capacitor is selected based on output voltage ripple and transient response requirements. As a result of the nature of the hysteretic control loop, a minimum ESR of a few tens of $\text{m}\Omega$ should be maintained for good operation unless a feed-forward resistor is used. Low ESR bulk tantalum or PosCap capacitors work best in most applications. A 1- μF ceramic capacitor can be used in parallel with this capacitor to filter higher frequency spikes. The output voltage ripple can be estimated by Equation 11.

$$\Delta V_{\text{PP}} = \Delta I \times \left[\text{ESR} + \left(\frac{1}{8 \times C_{\text{OUT}} \times f} \right) \right] \approx 1.1 \Delta I \times \text{ESR} \quad (11)$$

To calculate the capacitance needed to achieve a given voltage ripple as a result of a load transient from zero output to full current, use Equation 12.

$$C_{\text{OUT}} = \frac{L \times \Delta I_{\text{OUT}}^2}{(V_{\text{IN}} - V_{\text{OUT}}) \times \Delta V} \quad (12)$$

If only ceramic or other very low ESR output capacitor configurations are desired, additional voltage ripple must be passed to the feedback pin. See Application Note, Using Ceramic Output Capacitors with the TPS6420x Buck Controllers (SLVA210), for detailed application information.

Output Voltage Ripple Effect on V_{OUT} (Buck Controllers)

Output voltage ripple causes V_{OUT} to be higher or lower than the target value by half of the peak-to-peak voltage ripple. For minimum on-time, the ripple adds to the voltage; for minimum off-time, it subtracts from the voltage.

Soft-Start Capacitor Selection (Buck Controllers)

BUCK1 is discussed in this section; it is identical to BUCK2. Soft-start is implemented on the buck controllers by ramping current limit from 0 to its target value (set by R1) over a user-defined time. This time is set by the external soft-start cap connected to pin SS1. If SS1 is left open, a small on-chip capacitor will provide a current limit ramp time of approximately 250 μs . Figure 25 shows the effects of R1 and SS1 on the current limit start-up ramp.

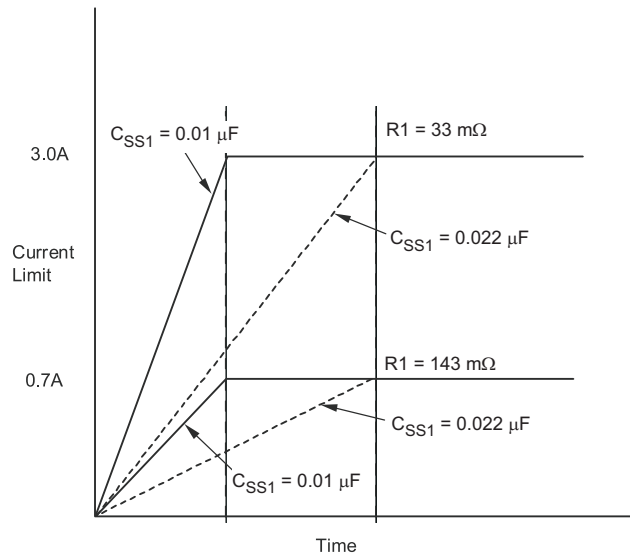

Figure 25. Effects of C_{SS1} and R_1 on Current Ramp Limit

This soft-start current limit ramp can be used to provide inrush current control or output voltage ramp control. While the current limit ramp can be easily understood by looking at [Figure 25](#), the output voltage ramp is a complex function of many variables. The dominant variables in this process are V_{OUT1} , C_{SS1} , I_{OUT1} , and R_1 . Less important variables are V_{IN1} and L_1 .

The best way to set a target start-up time is through bench measurement under target conditions, adjusting C_{SS1} to get the desired startup profile. To stay above a minimum start-up time, set the nominal start-up time to approximately five times the minimum. To stay below a maximum time, set the nominal start-up time at one-fifth of the maximum. Fastest start-up times occur at maximum V_{IN1} , with minimum V_{OUT1} , L_1 , C_{OUT1} , C_{SS1} , and I_{OUT1} . Slowest start-up times occur under opposite conditions.

See [Figure 11](#) to [Figure 14](#) for characterization curves showing how the start-up profile is affected by these critical parameters.

Output Voltage Setting Selection (Buck Controllers)

Output voltage is set using two resistors as shown for Buck2 in [Figure 2](#). Output voltage is then calculated using [Equation 13](#).

$$V_{OUT} = V_{FB} \left(\frac{R_5}{R_6} + 1 \right) \quad (13)$$

where $V_{FB} = 1.24V$.

LDO OPERATION

The TPS75003 LDO uses a PMOS pass element and is offered in an adjustable version for ease of programming to any output voltage. When used to power $V_{CC,AUX}$ it is set to 2.5 V; it can optionally be set to other output voltages to power other circuitry. The LDO has integrated soft-start, independent enable, and short-circuit and thermal protection. The LDO can be used to power $V_{CC,AUX}$ on the Xilinx Spartan-3 FPGA when 3.3-V JTAG signals are used as described in Application Note [SLVA159](#) (available for download from [www.ti.com](#)).

Input Capacitor Selection (LDO)

Although an input capacitor is not required, it is good analog design practice to connect a 0.1- μF to 10- μF low ESR capacitor across the input supply near the regulator. This capacitor counteracts reactive input sources and improves transient response, stability, and ripple rejection. A higher value capacitor may be needed if large, fast rise-time load transients are anticipated, or if the device is located far from its power source.

Output Capacitor Selection (LDO)

A 2.2 μF or greater capacitor is required near the output of the device to ensure stability. The LDO is stable with any capacitor type, including ceramic. If improved transient response or ripple rejection is required, larger and/or lower ESR output capacitors can be used.

Soft-Start (LDO)

The LDO uses an external soft-start capacitor, C_{SS3} , to provide an RC-ramped reference voltage to the control loop. (See the Functional Block Diagram.) This is a voltage-controlled soft-start, as compared to the current-controlled soft-start used by the buck controllers.

Setting Output Voltage (LDO)

Output voltage is set using two resistors as shown in [Figure 2](#). Output voltage is then calculated using [Equation 14](#).

$$V_{\text{OUT}} = V_{\text{FB}} \left(\frac{R_3}{R_4} + 1 \right) \quad (14)$$

where $V_{\text{FB}} = 0.507 \text{ V}$.

Internal Current Limit (LDO)

The internal current limit of the LDO helps protect the regulator during fault conditions. When an over-current condition is detected, the output voltage will be reduced until the current falls to a level that will not damage the device. For good device reliability, the LDO should not operate at current limit.

Enable Pin (LDO)

The active high enable pin (EN3) can be used to put the device into shutdown mode. If shutdown and soft-start capability are not required, EN3 can be tied to IN3.

Dropout Voltage (LDO)

The LDO uses a PMOS transistor to achieve low dropout. When $(V_{\text{IN}} - V_{\text{OUT}})$ is less than the dropout voltage (V_{DO}), the pass device is in its linear region of operation, and the input-output resistance is the $R_{\text{DS,ON}}$ of the pass transistor. In this region, the regulator is said to be out of regulation; ripple rejection, line regulation, and load regulation degrade as $(V_{\text{IN}} - V_{\text{OUT}})$ falls much below 0.5 V.

Transient Response (LDO)

The LDO does not have an on-chip pulldown circuit for output is over-voltage conditions. This feature permits applications that connect higher voltage sources such as an alternate power supply to the output. This design also results in an output overshoot of several percent if the load current quickly drops to zero. The amplitude of overshoot can be reduced by increasing C_{OUT} ; the duration of overshoot can be reduced by adding a load resistor.

Thermal Protection (LDO)

Thermal protection disables the output when the junction temperature, T_{J} , reaches unsafe levels. When the junction cools, the output is again enabled. Depending on power dissipation, thermal resistance, and ambient temperature, the thermal protection circuit may cycle on and off. This cycling limits the dissipation of the regulator, protecting it from damage. For good long term reliability, the device should not be continuously operated at or near thermal shutdown.

Power Dissipation (LDO)

The TPS75003 comes in a QFN-style package with an exposed lead frame on the package underside. The exposed lead frame is the primary path for removing heat and should be soldered to a PC board that is configured to remove the amount of power dissipated by the LDO, as calculated by Equation 15.

$$P_D = (V_{IN3} - V_{OUT3}) \times I_{OUT3} \tag{15}$$

Power dissipation can be minimized by using the lowest possible input voltage necessary to assure the required output voltage. The two buck converters do not contribute a significant amount of dissipated power. Using heavier copper increases the overall effectiveness of removing heat from the device. The addition of plated through-holes to heat-dissipating layers also improves the heatsink effectiveness.

PCB Layout Considerations

As with any switching regulators, careful attention must be paid to board layout. A typical application circuit and corresponding recommended printed circuit board (PCB) layout with emphasis on the most sensitive areas are shown in Figure 26 through Figure 28.

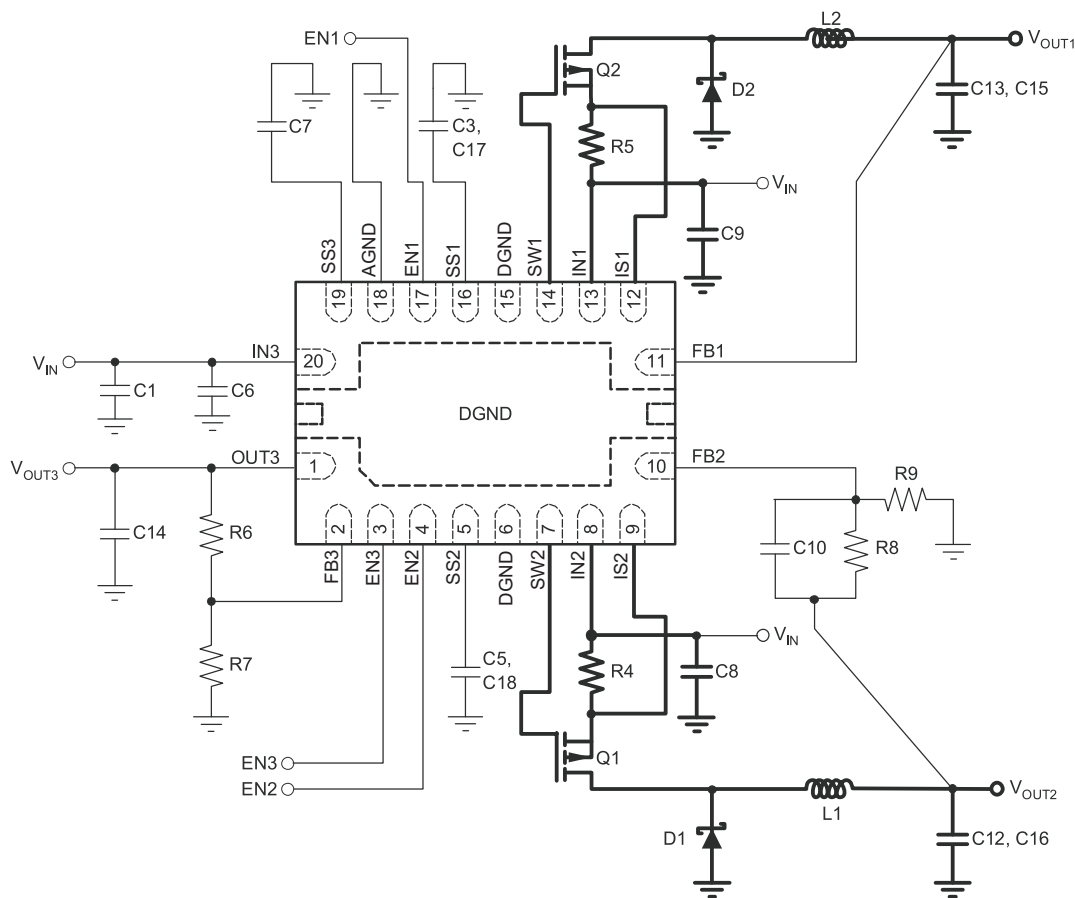

Note: Most sensitive areas are highlighted by bold lines.

Figure 26. Typical Application Circuit

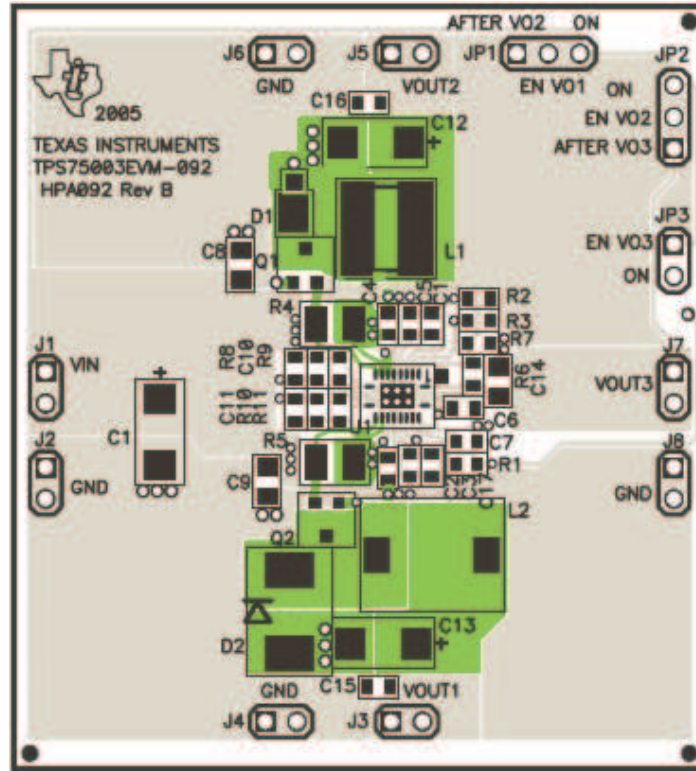

Note: Most sensitive areas are highlighted in green.

Figure 27. Recommended PCB Layout, Component Side, Top View

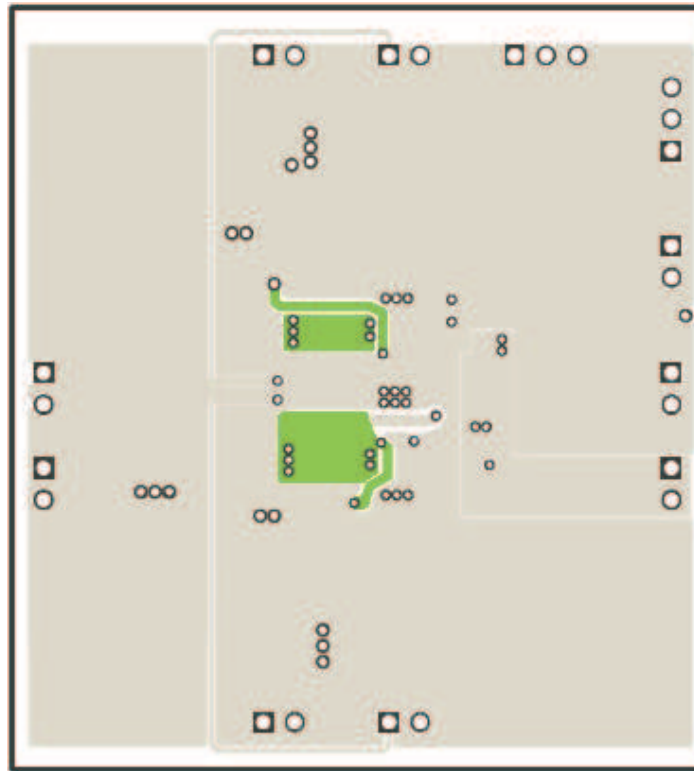

Note: Most sensitive areas are highlighted in green.

Figure 28. Recommended PCB Layout, Bottom Side, Top View

REVISION HISTORY

Changes from Original (December 2006) to Revision A	Page
• Replaced the DISSIPATION RATINGS table with the Thermal Information Table	3

TAPE AND REEL INFORMATION

QUADRANT ASSIGNMENTS FOR PIN 1 ORIENTATION IN TAPE

*All dimensions are nominal

Device	Package Type	Package Drawing	Pins	SPQ	Reel Diameter (mm)	Reel Width W1 (mm)	A0 (mm)	B0 (mm)	K0 (mm)	P1 (mm)	W (mm)	Pin1 Quadrant
TPS75003MRHLREP	VQFN	RHL	20	3000	330.0	12.4	3.8	4.8	1.6	8.0	12.0	Q1

TAPE AND REEL BOX DIMENSIONS



*All dimensions are nominal

Device	Package Type	Package Drawing	Pins	SPQ	Length (mm)	Width (mm)	Height (mm)
TPS75003MRHLREP	VQFN	RHL	20	3000	367.0	367.0	35.0

GENERIC PACKAGE VIEW

RHL 20

VQFN - 1 mm max height

3.5 x 4.5 mm, 0.5 mm pitch

PLASTIC QUAD FLATPACK - NO LEAD

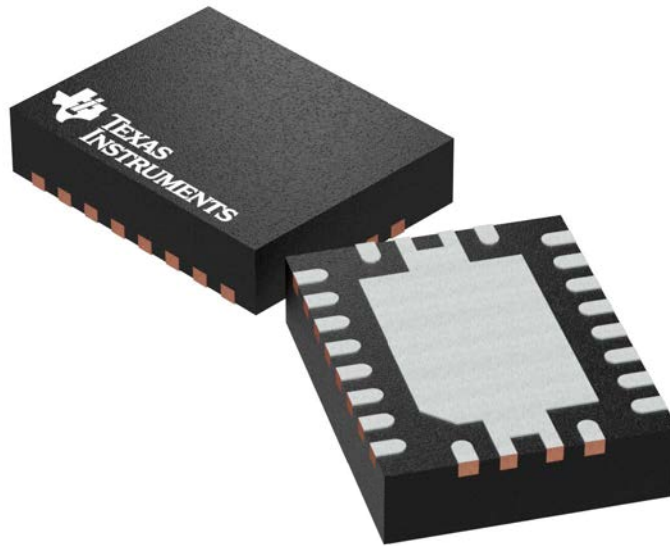

Images above are just a representation of the package family, actual package may vary.
Refer to the product data sheet for package details.

4205346/L

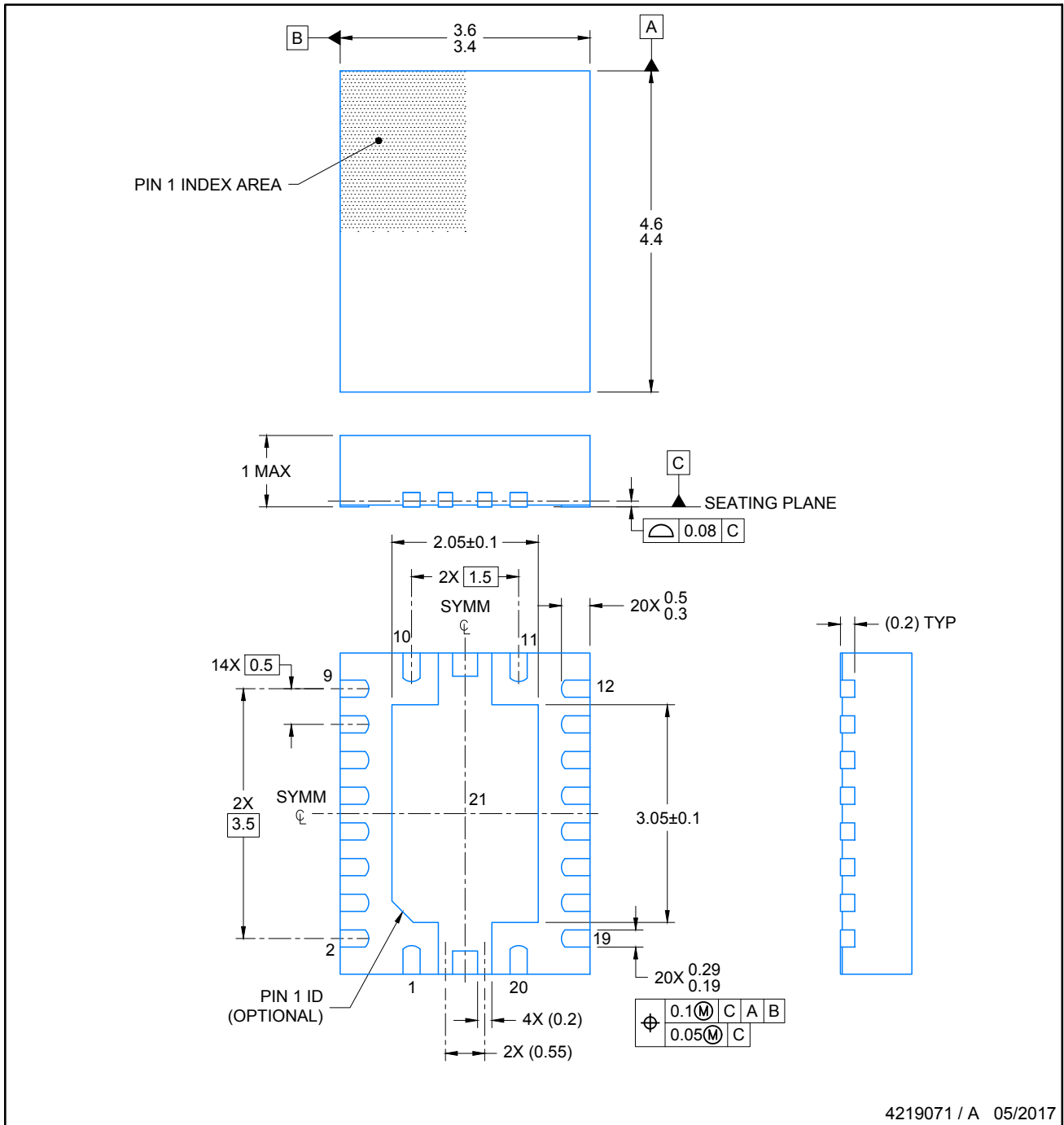

NOTES:

1. All linear dimensions are in millimeters. Any dimensions in parenthesis are for reference only. Dimensioning and tolerancing per ASME Y14.5M.
2. This drawing is subject to change without notice.
3. The package thermal pad must be soldered to the printed circuit board for thermal and mechanical performance.

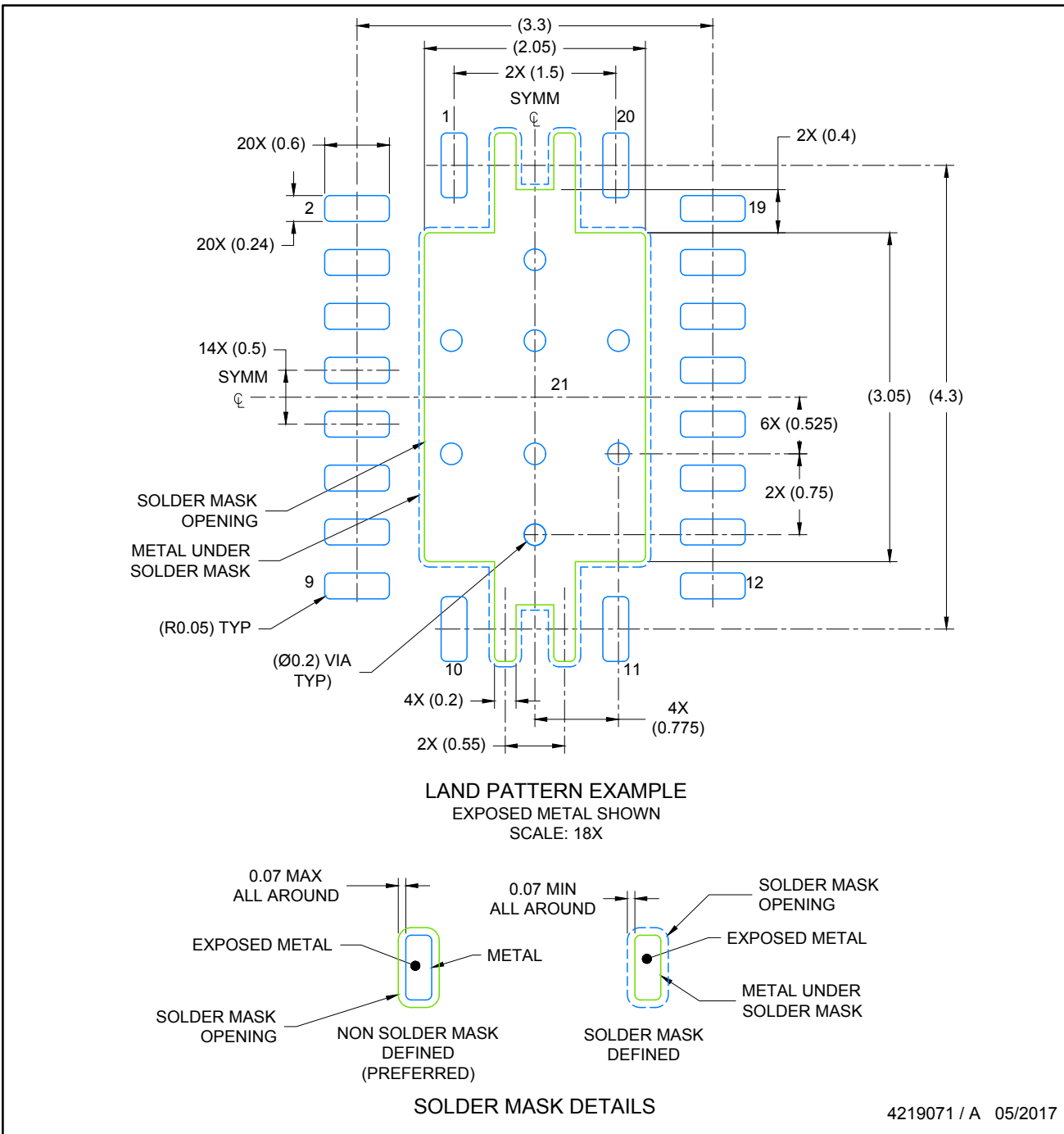

NOTES: (continued)

4. This package is designed to be soldered to a thermal pad on the board. For more information, see Texas Instruments literature number SLUA271 (www.ti.com/lit/sluea271).
5. Solder mask tolerances between and around signal pads can vary based on board fabrication site.
6. Vias are optional depending on application, refer to device data sheet. If any vias are implemented, refer to their locations shown on this view. It is recommended that vias under paste be filled, plugged or tented.

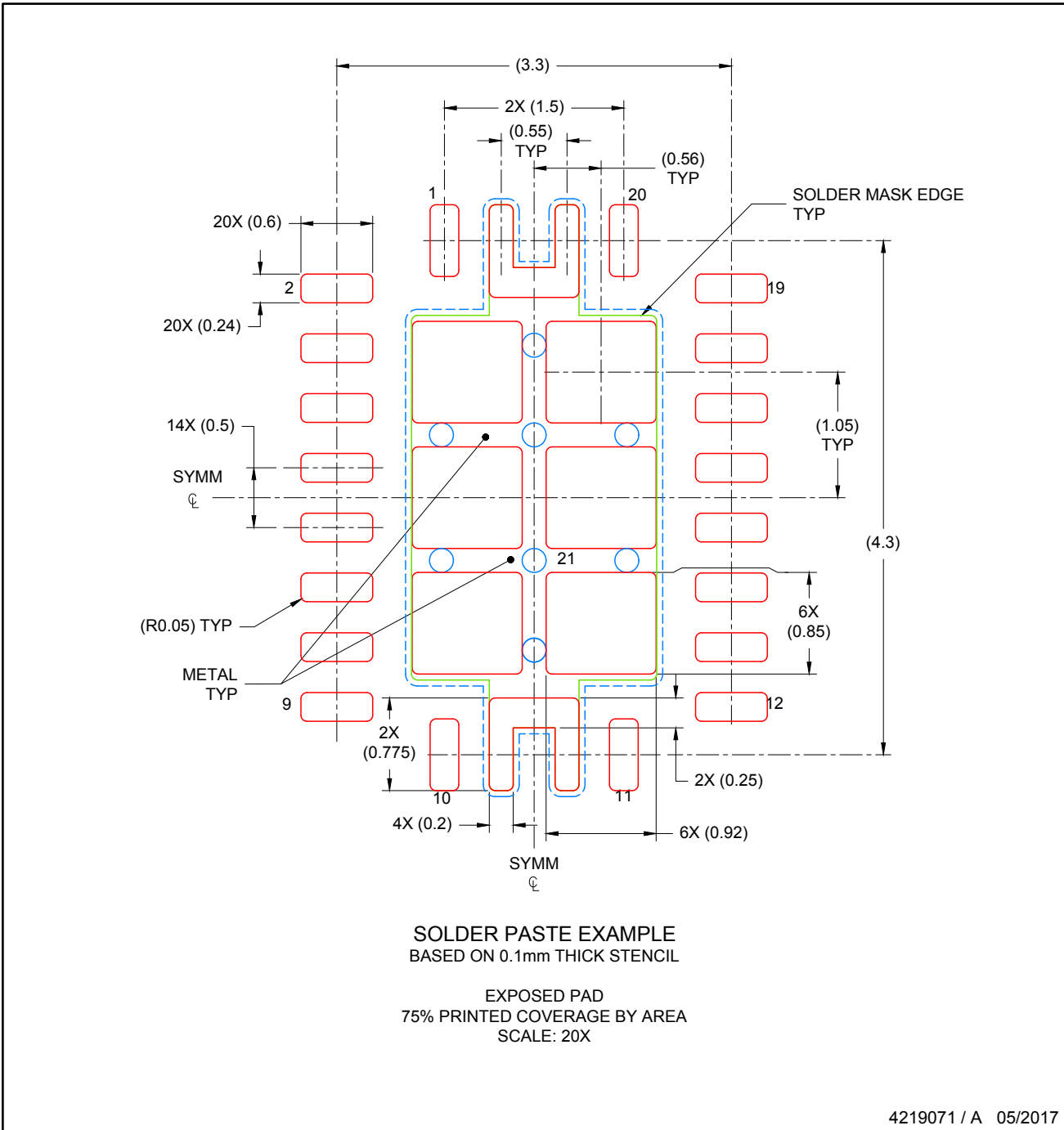

NOTES: (continued)

7. Laser cutting apertures with trapezoidal walls and rounded corners may offer better paste release. IPC-7525 may have alternate design recommendations..

IMPORTANT NOTICE

Texas Instruments Incorporated (TI) reserves the right to make corrections, enhancements, improvements and other changes to its semiconductor products and services per JESD46, latest issue, and to discontinue any product or service per JESD48, latest issue. Buyers should obtain the latest relevant information before placing orders and should verify that such information is current and complete.

TI's published terms of sale for semiconductor products (<http://www.ti.com/sc/docs/stdterms.htm>) apply to the sale of packaged integrated circuit products that TI has qualified and released to market. Additional terms may apply to the use or sale of other types of TI products and services.

Reproduction of significant portions of TI information in TI data sheets is permissible only if reproduction is without alteration and is accompanied by all associated warranties, conditions, limitations, and notices. TI is not responsible or liable for such reproduced documentation. Information of third parties may be subject to additional restrictions. Resale of TI products or services with statements different from or beyond the parameters stated by TI for that product or service voids all express and any implied warranties for the associated TI product or service and is an unfair and deceptive business practice. TI is not responsible or liable for any such statements.

Buyers and others who are developing systems that incorporate TI products (collectively, "Designers") understand and agree that Designers remain responsible for using their independent analysis, evaluation and judgment in designing their applications and that Designers have full and exclusive responsibility to assure the safety of Designers' applications and compliance of their applications (and of all TI products used in or for Designers' applications) with all applicable regulations, laws and other applicable requirements. Designer represents that, with respect to their applications, Designer has all the necessary expertise to create and implement safeguards that (1) anticipate dangerous consequences of failures, (2) monitor failures and their consequences, and (3) lessen the likelihood of failures that might cause harm and take appropriate actions. Designer agrees that prior to using or distributing any applications that include TI products, Designer will thoroughly test such applications and the functionality of such TI products as used in such applications.

TI's provision of technical, application or other design advice, quality characterization, reliability data or other services or information, including, but not limited to, reference designs and materials relating to evaluation modules, (collectively, "TI Resources") are intended to assist designers who are developing applications that incorporate TI products; by downloading, accessing or using TI Resources in any way, Designer (individually or, if Designer is acting on behalf of a company, Designer's company) agrees to use any particular TI Resource solely for this purpose and subject to the terms of this Notice.

TI's provision of TI Resources does not expand or otherwise alter TI's applicable published warranties or warranty disclaimers for TI products, and no additional obligations or liabilities arise from TI providing such TI Resources. TI reserves the right to make corrections, enhancements, improvements and other changes to its TI Resources. TI has not conducted any testing other than that specifically described in the published documentation for a particular TI Resource.

Designer is authorized to use, copy and modify any individual TI Resource only in connection with the development of applications that include the TI product(s) identified in such TI Resource. NO OTHER LICENSE, EXPRESS OR IMPLIED, BY ESTOPPEL OR OTHERWISE TO ANY OTHER TI INTELLECTUAL PROPERTY RIGHT, AND NO LICENSE TO ANY TECHNOLOGY OR INTELLECTUAL PROPERTY RIGHT OF TI OR ANY THIRD PARTY IS GRANTED HEREIN, including but not limited to any patent right, copyright, mask work right, or other intellectual property right relating to any combination, machine, or process in which TI products or services are used. Information regarding or referencing third-party products or services does not constitute a license to use such products or services, or a warranty or endorsement thereof. Use of TI Resources may require a license from a third party under the patents or other intellectual property of the third party, or a license from TI under the patents or other intellectual property of TI.

TI RESOURCES ARE PROVIDED "AS IS" AND WITH ALL FAULTS. TI DISCLAIMS ALL OTHER WARRANTIES OR REPRESENTATIONS, EXPRESS OR IMPLIED, REGARDING RESOURCES OR USE THEREOF, INCLUDING BUT NOT LIMITED TO ACCURACY OR COMPLETENESS, TITLE, ANY EPIDEMIC FAILURE WARRANTY AND ANY IMPLIED WARRANTIES OF MERCHANTABILITY, FITNESS FOR A PARTICULAR PURPOSE, AND NON-INFRINGEMENT OF ANY THIRD PARTY INTELLECTUAL PROPERTY RIGHTS. TI SHALL NOT BE LIABLE FOR AND SHALL NOT DEFEND OR INDEMNIFY DESIGNER AGAINST ANY CLAIM, INCLUDING BUT NOT LIMITED TO ANY INFRINGEMENT CLAIM THAT RELATES TO OR IS BASED ON ANY COMBINATION OF PRODUCTS EVEN IF DESCRIBED IN TI RESOURCES OR OTHERWISE. IN NO EVENT SHALL TI BE LIABLE FOR ANY ACTUAL, DIRECT, SPECIAL, COLLATERAL, INDIRECT, PUNITIVE, INCIDENTAL, CONSEQUENTIAL OR EXEMPLARY DAMAGES IN CONNECTION WITH OR ARISING OUT OF TI RESOURCES OR USE THEREOF, AND REGARDLESS OF WHETHER TI HAS BEEN ADVISED OF THE POSSIBILITY OF SUCH DAMAGES.

Unless TI has explicitly designated an individual product as meeting the requirements of a particular industry standard (e.g., ISO/TS 16949 and ISO 26262), TI is not responsible for any failure to meet such industry standard requirements.

Where TI specifically promotes products as facilitating functional safety or as compliant with industry functional safety standards, such products are intended to help enable customers to design and create their own applications that meet applicable functional safety standards and requirements. Using products in an application does not by itself establish any safety features in the application. Designers must ensure compliance with safety-related requirements and standards applicable to their applications. Designer may not use any TI products in life-critical medical equipment unless authorized officers of the parties have executed a special contract specifically governing such use. Life-critical medical equipment is medical equipment where failure of such equipment would cause serious bodily injury or death (e.g., life support, pacemakers, defibrillators, heart pumps, neurostimulators, and implantables). Such equipment includes, without limitation, all medical devices identified by the U.S. Food and Drug Administration as Class III devices and equivalent classifications outside the U.S.

TI may expressly designate certain products as completing a particular qualification (e.g., Q100, Military Grade, or Enhanced Product). Designers agree that it has the necessary expertise to select the product with the appropriate qualification designation for their applications and that proper product selection is at Designers' own risk. Designers are solely responsible for compliance with all legal and regulatory requirements in connection with such selection.

Designer will fully indemnify TI and its representatives against any damages, costs, losses, and/or liabilities arising out of Designer's non-compliance with the terms and provisions of this Notice.