

**PLEASE CHECK WWW.MOLEX.COM FOR LATEST PART INFORMATION**

**Part Number:** **0334820602**  
**Status:** **Active**  
**Overview:** mx150 sealed connector system  
**Description:** 3.50mm (.138") Pitch MX150™ Sealed Male Connector, Dual Row, 6 Circuits, Polarization B, without Connector Position Assurance, Gray

**Documents:**

[3D Model](#)  
[Application Specification \(PDF\)](#)  
[Drawing \(PDF\)](#)  
[Product Specification PS-33472-000 \(PDF\)](#)  
[RoHS Certificate of Compliance \(PDF\)](#)

**General**

Product Family	Crimp Housings
Series	<u>33482</u>
Comments	No Connector Position Assurance (CPA)
More Detailed Tech Information	<a href="http://ewcap.uscarteams.org">http://ewcap.uscarteams.org</a>
Overview	<u>mx150 sealed connector system</u>
Product Name	MX150™

**Physical**

Circuits (maximum)	6
Circuits Detail	6
Color - Resin	Black, Gray (Light), Natural
Gender	Male
Glow-Wire Compliant	No
Keying to Mating Part	Yes
Lock to Mating Part	Yes
Material - Resin	Modified Polystyrene Alloy
Number of Rows	2
Packaging Type	Bag
Panel Mount	No
Pitch - Mating Interface (in)	0.138 In
Pitch - Mating Interface (mm)	3.50 mm
Polarized to Mating Part	Yes
Stackable	No
Temperature Range - Operating	-40°C to +125°C

**Electrical**

Current - Maximum per Contact	22A
-------------------------------	-----

**Material Info**

**Reference - Drawing Numbers**

Application Specification	AS-33472-100
Packaging Specification	PK-30907-811, PK-31300-635
Product Specification	PS-33472-000
Sales Drawing	SD-33482-061



**EU RoHS**

**ELV and RoHS Compliant**  
**REACH SVHC Contains SVHC: No**  
**Halogen-Free Status**  
**Not Reviewed**

**China RoHS**



**Need more information on product environmental compliance?**

Email [productcompliance@molex.com](mailto:productcompliance@molex.com)  
 For a multiple part number RoHS Certificate of Compliance, [click here](#)

Please visit the [Contact Us](#) section for any non-product compliance questions.

**Search Parts in this Series**

33482Series

**Mates With**

33472 Female Dual Row Sealed Connector

**Use With**

33000 MX150™ Tin (Sn) Male Terminal,  
33011 Gold (Au) Male Terminal

ASSEMBLY PART NUMBER	COLOR	KEYING OPTION	DIMENSIONS (DEGREES)		CAVITY TYPE & STATUS (X = PLUGGED)						STATUS
			A	B	1	2	3	4	5	6	
33482-0601	BLACK	A	60	60							SALEABLE
33482-0602	LT.GRAY	B	25	60							DESIGN CONCEPT
33482-0603	BROWN	C	60	25							DESIGN CONCEPT
33482-0604	GREEN	D	25	25							DESIGN CONCEPT
33482-0605			VOIDED								
33482-0606	BLACK	A	60	60				X			SALEABLE
33482-0607	LT.GRAY	B	25	60				X			DESIGN CONCEPT
33482-0608	BROWN	C	60	25				X			DESIGN CONCEPT
33482-0609	GREEN	D	25	25				X			DESIGN CONCEPT
33482-0610			VOIDED								
33482-0611	BLACK	A	60	60				X	X		SALEABLE
33482-0612	LT.GRAY	B	25	60				X	X		DESIGN CONCEPT
33482-0613	BROWN	C	60	25				X	X		DESIGN CONCEPT
33482-0614	GREEN	D	25	25				X	X		DESIGN CONCEPT
33482-0615			VOIDED								
33482-0616	BLACK	A	60	60				X			SALEABLE
33482-0617	BLACK	A	60	60			X				SALEABLE
33482-0618	BLACK	A	60	60					X	X	SALEABLE
33482-0619	BLACK	A	60	60			X	X	X	X	SALEABLE
33482-0620	BLACK	A	60	60	X	X	X	X	X	X	SALEABLE
33482-0621	BLACK	A	60	60	X			X	X		SALEABLE
33482-0622	BLACK	A	60	60				X	X	X	SALEABLE
33482-0623	BLACK	A	60	60				X			SALEABLE
33482-0624	BLACK	A	60	60						X	SALEABLE
33482-0625	LT.GRAY	B	25	60	X				X		DESIGN CONCEPT
33482-0626	BLACK	A	60	60	X	X	X	X			SALEABLE
33482-0627	BLACK	A	60	60	X	X		X	X		SALEABLE

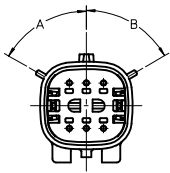

KEYING OPTION  
SEE TABLE  
SCALE 2:1

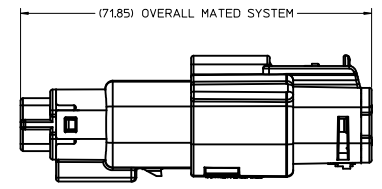

SCALE 1:1

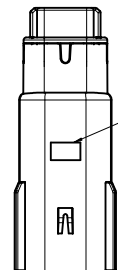

OPTIONAL TRACEABILITY INFORMATION LOCATED IN THIS AREA

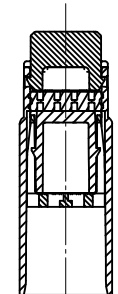

SECTION A-A

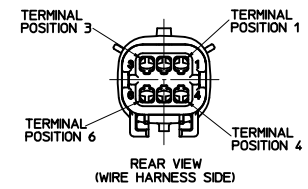

REAR VIEW  
(WIRE HARNESS SIDE)

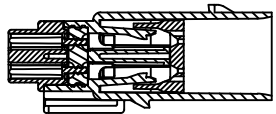
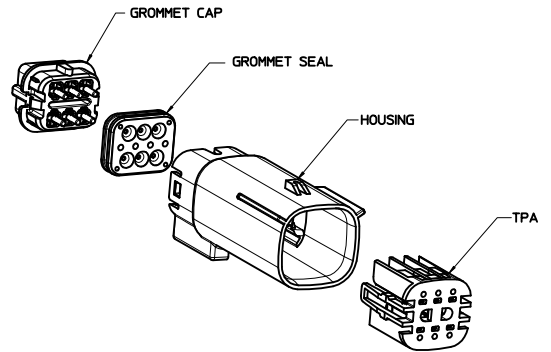

SECTION B-B  
(BLADE SHOWN IN FULL-LOCK POSITION)  
SEE NOTE 2

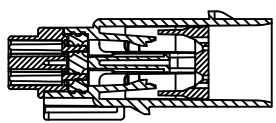

SECTION C-C  
(BLADE SHOWN IN PRE-LOCK POSITION)  
SEE NOTE 2

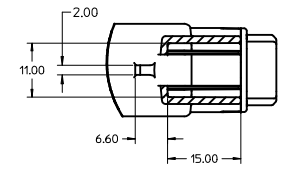
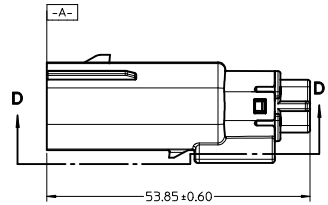
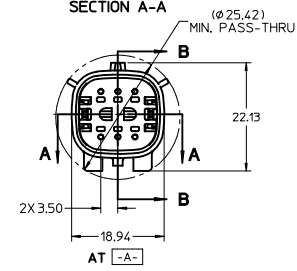

SECTION D-D

NOTES: UNLESS OTHERWISE SPECIFIED

- DESIGNED TO MATE WITH RECEPTACLE HOUSING ASSEMBLY SPECIFIED IN MOLEX CHARTED DRAWING SD-33472-061.
- ASSEMBLY SHIPPED WITH BLADE INSERT IN PRE-LOCK POSITION (SEE SECTION D-D PRE-LOCK). UPON FULL TERMINAL ASSEMBLY, EACH BLADE INSERT MUST BE SNAPPED INTO ITS FINAL-LOCK POSITION.
- FOR BLADE TERMINALS TO BE USED WITH THIS ASSEMBLY, SEE DRAWING SD-33000-001.
- SYSTEM TO BE USED WITH WIRE WITHIN DIAMETER RANGE OF 1.5mm TO 2.5mm.
- MATERIAL: SPS/NYLON BLEND, 20% GLASS FILLED.
- SHALL CONFORM TO PACKAGING SPECIFICATION PK-31300-635.
- SHALL CONFORM TO PRODUCT SPECIFICATION PS-33472-000.
- ASSEMBLY CONFORMS TO SAE/USCAR-2 REV 4 WITH THE FOLLOWING EXCEPTIONS:  
TERMINAL INSERTION FORCE FOR WIRE SIZE ABOVE 2.5mm NOT EXCEEDING 2.69mm SHALL NOT EXCEED 45 NEWTONS.

<b>REDRAWN</b> EC NO: UAU2010-1806 DRAWN BY: CHYKORRFFTHS CHECKED BY: APPR:VKOSHY 2010/06/03 2010/06/11 2010/06/11	QUALITY SYMBOLS ▽=0 ▽=0	GENERAL TOLERANCES (UNLESS SPECIFIED) mm INCH 4 PLACES ±--- ±--- 3 PLACES ±0.10 ±--- 2 PLACES ±0.3 ±--- 1 PLACE ±0.3 ±--- ANGULAR ± 3°	DIMENSION STYLE MM ONLY SCALE 2:1 DESIGN UNITS METRIC THIRD ANGLE PROJECTION	DRAWN BY: DMARCOUX DATE: 06-17-02 CHECKED BY: DGRIFFFTHS DATE: 06-17-02 APPROVED BY: VKOSHY DATE: 2010/03/12	TITLE: MX150 BLADE CONNECTOR ASSEMBLY 2 ROW SEALED, 6 WAY MOLEX INCORPORATED MATERIAL NO. AS NOTED DOCUMENT NO. SD-33482-061 SHEET NO. 1 OF 1
	DRAFT WHERE APPLICABLE MUST REMAIN WITHIN DIMENSIONS		THIS DRAWING CONTAINS INFORMATION THAT IS PROPRIETARY TO MOLEX INCORPORATED AND SHOULD NOT BE USED WITHOUT WRITTEN PERMISSION		