

Coaxial Amplifier

ZHL-2W-63-S+ ZHL-2W-63X-S+

50Ω Medium High Power 600 to 6000 MHz

The Big Deal

- Wideband, 600 to 6000 MHz
- High gain, 42 dB typ.
- High OIP3, +38 dBm typ.



ZHL-2W-63X-S+



ZHL-2W-63-S+

Product Overview

Mini-Circuits' ZHL-2W-63-S+ is class AB a medium-power connectorized amplifier with GaN output transistor supporting a wide range of applications from 600 to 6000 MHz, such as test instrumentation, SatCom, and mobile communications systems, including those operating in the new telecom Band 71 allocation (617 to 698 MHz). This model provides +33 dBm output power at saturation. The amplifier operates on a 28V DC supply and comes housed in compact aluminum alloy case (7.00 x 3.25 x 1.12") with SMA connectors, built-in bracket for mounting, and an optional heat sink for efficient cooling.

Key Features

Feature	Advantages
Wideband, usable from 500 to 6100 MHz	One amplifier supports a broad range of system and test lab applications. Extended bandwidth down to 600 MHz supports new telecom Band 71 allocation (617 to 698 MHz)
High gain, 42 dB	Reduces the number of gain stages, lowering component count and overall system cost.
Medium output power, +33 dBm	Supports a wide range of power requirements.
High OIP3, +38 dBm	Provides highly linear performance with excellent sensitivity and two-tone spur-free dynamic range.

Coaxial Amplifier

ZHL-2W-63-S+ ZHL-2W-63X-S+

50Ω Medium High Power 600 to 6000 MHz

Features

- wideband, 600 to 6000 MHz
- high OIP3, +38 dBm typ.
- high gain, 42 dB typ.

Applications

- communication systems
- cellular
- instrumentation
- laboratory

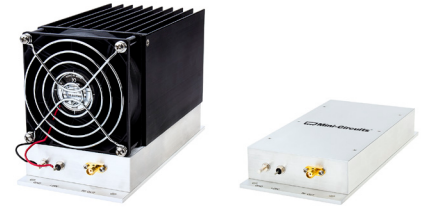

Generic photo used for illustration purposes only

Model No.	ZHL-2W-63-S+	ZHL-2W-63X-S+ [▲]
Case Style	CP2548-1	
Connectors	SMA	

+RoHS Compliant

The +Suffix identifies RoHS Compliance. See our web site for RoHS Compliance methodologies and qualifications

Electrical Specifications at 25°C

Parameter	Condition (MHz)	ZHL-2W-63-S+ ▲ZHL-2W-63X-S+			Units
		Min.	Typ.	Max.	
Frequency Range		600	—	6000	MHz
Gain	600-6000	34	42	51	dB
Gain Flatness	600-6000	—	±3.5	—	dB
Output Power at 3dB compression	600-6000	—	+31	—	dBm
Output Power at saturation	600-6000	+31	+33	—	dBm
Noise Figure	600-6000	—	12	—	dB
Output third order intercept point	600-6000	—	38	—	dBm
Input VSWR	600-6000	—	2.5	—	:1
Output VSWR	600-6000	—	3.5	—	:1
DC Supply Voltage		—	28	—	V
Supply Current		—	1.5	2.0	A

▲Heat sink not included. Alternative heat sinking and heat removal must be provided by the user to limit maximum base-plate temperature to 85°C, in order to ensure proper performance. For reference, this requires thermal resistance of user's external heat sink to be 0.4°C/W max.

Maximum Ratings

Parameter	Ratings
Operating Temperature	0°C to 60°C
Storage Temperature	-55°C to 100°C
DC Voltage	+32V
Input RF Power (no damage) at load	+7 dBm
Input RF power at OPEN / SHORT	-21 dBm

Permanent damage may occur if any of these limits are exceeded.

Outline Drawing

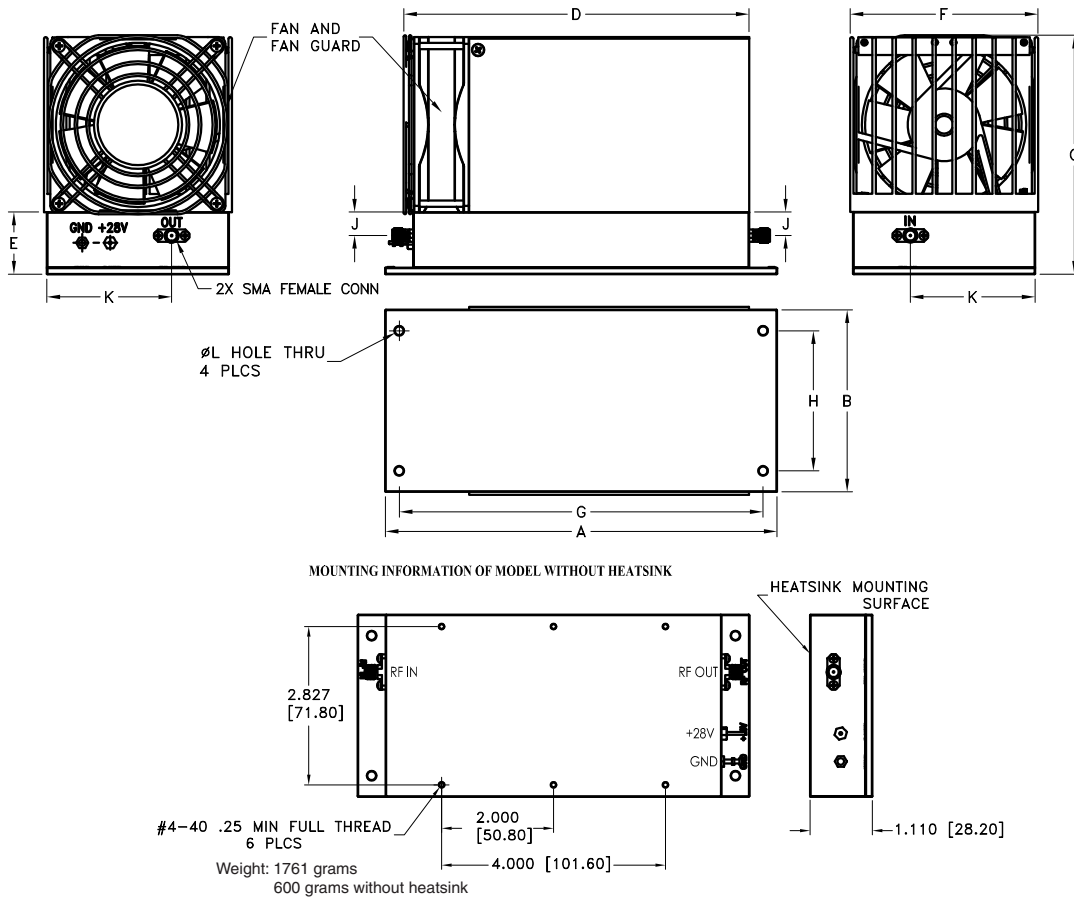

Outline Dimensions (inch/mm)

A	B	C	D	E	F	G	H	J	K	L	wt
7.00	3.25	4.27	6.17	1.12	3.36	6.50	2.50	0.42	2.23	0.16	grams*
177.8	82.55	108.46	156.72	28.448	85.344	165.1	63.5	10.668	56.642	3.9878	1761

*600 grams without heatsink

Typical Performance Data/Curves

ZHL-2W-63-S+ ZHL-2W-63X-S+

FREQUENCY (MHz)	GAIN (dB)	DIRECTIVITY (dB)	VSWR (:1)		NOISE FIGURE (dB)	POUT at 3 dB COMPR. (dBm)	POUT at SATURATION (dBm)	OIP3 (dBm)
	28V	28V	IN	OUT	28V	28V	28V	15V
600	40.54	66.68	2.46	1.78	10.40	34.95	35.69	45.51
1000	40.13	59.78	1.63	1.53	9.67	35.72	36.68	45.45
1500	41.89	49.83	1.68	1.53	9.47	35.74	36.34	46.20
2000	40.55	48.79	1.56	1.83	9.51	34.60	35.95	44.58
2500	44.65	42.29	1.47	1.56	9.60	33.04	35.07	44.36
3000	42.50	43.88	1.65	1.48	9.86	31.41	35.19	43.49
3500	43.90	40.05	1.54	1.44	10.16	33.44	34.89	44.43
4000	41.57	43.62	1.41	1.68	10.48	31.83	33.80	43.84
4500	42.31	42.11	1.41	1.20	10.77	33.09	35.22	43.06
5000	40.48	44.54	1.53	1.49	10.97	30.83	34.04	40.22
5500	40.76	40.47	1.31	1.03	11.23	31.85	34.17	40.55
6000	40.39	43.03	1.11	2.40	11.46	26.87	33.98	36.89

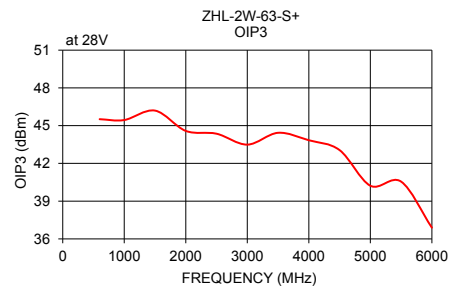
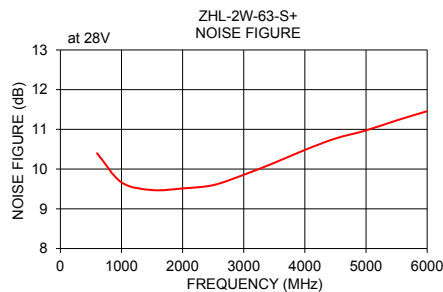
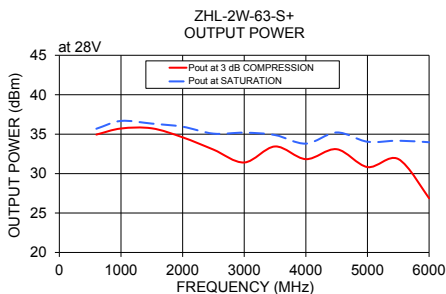
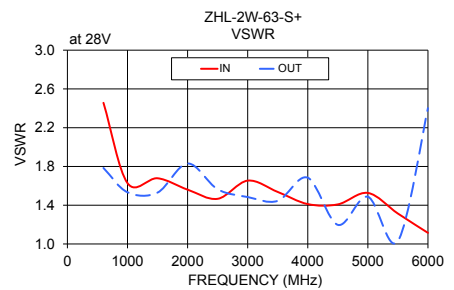
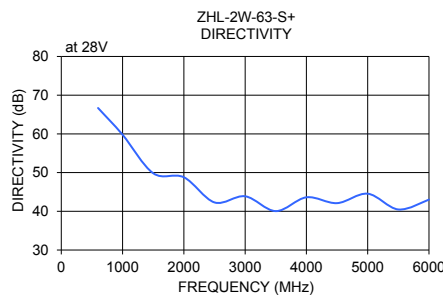
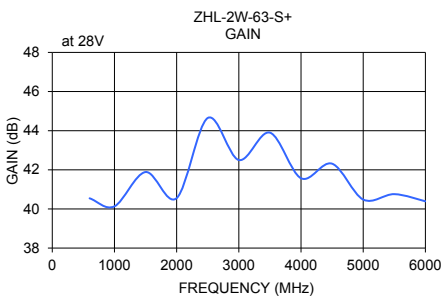

Additional Notes

- Performance and quality attributes and conditions not expressly stated in this specification document are intended to be excluded and do not form a part of this specification document.
- Electrical specifications and performance data contained in this specification document are based on Mini-Circuit's applicable established test performance criteria and measurement instructions.
- The parts covered by this specification document are subject to Mini-Circuit's standard limited warranty and terms and conditions (collectively, "Standard Terms"); Purchasers of this part are entitled to the rights and benefits contained therein. For a full statement of the Standard Terms and the exclusive rights and remedies thereunder, please visit Mini-Circuit's website at www.minicircuits.com/MCLStore/terms.jsp