



PUSB220

TVS

DUAL USB 2.0 INTEGRATED ESD PROTECTION

DESCRIPTION

The UTC **PUSB220** is a dual USB 2.0 integrated ESD protection diode array. it uses UTC's advanced technology to provide customers with low leakage current, 4 ultra-low input capacitance rail-to-rail ESD protection diodes and low clamping voltage, etc.

The UTC **PUSB220** is suitable for DVI, Ethernet and USB2.0, etc.

FEATURES

- * Low clamping voltage
- * Low leakage current (Max.=100nA)
- * Four ultra-low input capacitance (typical 1pF)

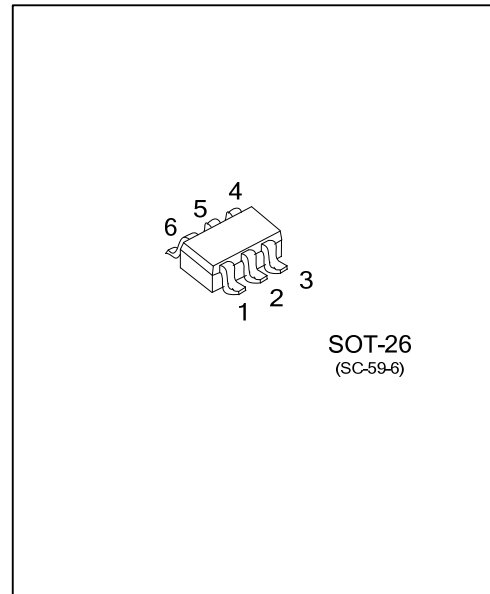

ORDERING INFORMATION

Ordering Number		Package	Packing
Lead Free	Halogen Free		
PUSB220L-AG6-R	PUSB220G-AG6-R	SOT-26	Tape Reel

<p>PUSB220L-AG6-R</p> <ul style="list-style-type: none"> (1)Packing Type (2)Package Type (3)Lead Free 	<ul style="list-style-type: none"> (1) R: Tape Reel (2) AG6 : SOT-26 (3) L: Lead Free, G: Halogen Free
--	---

MARKING

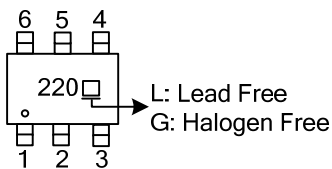

■ PIN CONFIGURATION

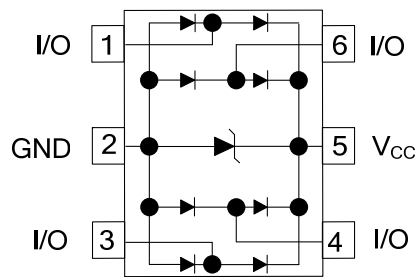

■ PIN DESCRIPTION

PIN NO.	PIN NAME	DESCRIPTION
1	I/O	Terminal of ESD 1
2	GND	Ground
3	I/O	Terminal of ESD 2
4	I/O	Terminal of ESD 3
5	V _{CC}	Supply Voltage
6	I/O	Terminal of ESD 4

■ ABSOLUTE MAXIMUM RATINGS

PARAMETER	SYMBOL	RATINGS	UNIT
DC Input Voltage Range	V_{IN}	0~+5.5	V
ESD Voltage (HBM Contact)	V_{ESD}	-8~+8	kV
Storage Temperature	T_{STG}	-55~+125	°C
Operating Temperature Range	T_{OPR}	-40~+85	°C

Note: 1. Absolute maximum ratings are those values beyond which the device could be permanently damaged. Absolute maximum ratings are stress ratings only and functional device operation is not implied.
 2. IEC 61000-4-2 level 4.

■ ELECTRICAL CHARACTERISTICS ($T_C=25^{\circ}C$ unless otherwise specified.)

PARAMETER	SYMBOL	TEST CONDITIONS	MIN	TYP	MAX	UNIT
Pin Capacitance to Ground, Pins 1, 3, 4, 6	$C_{I/O}$	$V_{IN}=0V, f=1MHz, V_{CC}=3.0V$		1.0		pF
Diode Reverse Leakage Current, Pins 1, 3, 4, 6 to Ground	I_{IKG}	$V_I=3.0V$			100	nA
Zener Diode Capacitance to Ground, Pin 5 to 2	C_{ZENER}	$V_{IN}=0V, f=1MHz, V_{CC}=3.0V$		40		pF
Zener Diode Breakdown Voltage, Pin 5 to 2	$V_{BR I/O}$	$I=1mA$	6		9	V
Forward Voltage	V_F			0.7		V

■ TYPICAL CHARACTERISTICS

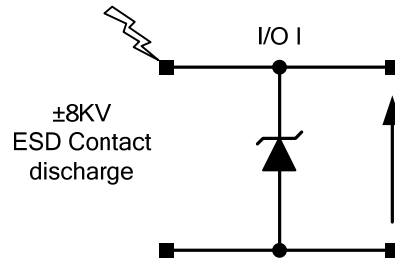

ESD Test Configuration

HBM +Voltage Waveform

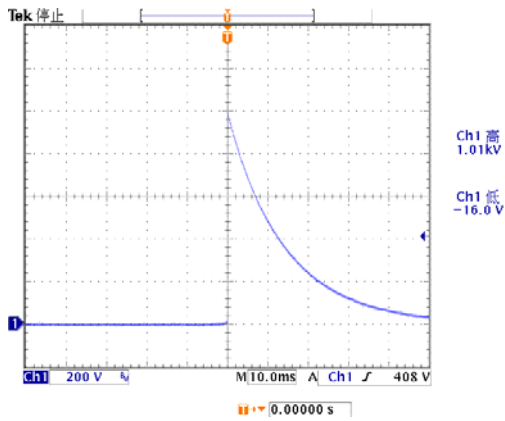

HBM +Voltage Waveform

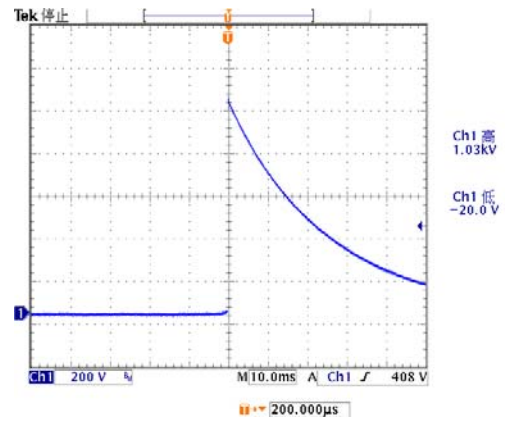

HBM -Voltage Waveform

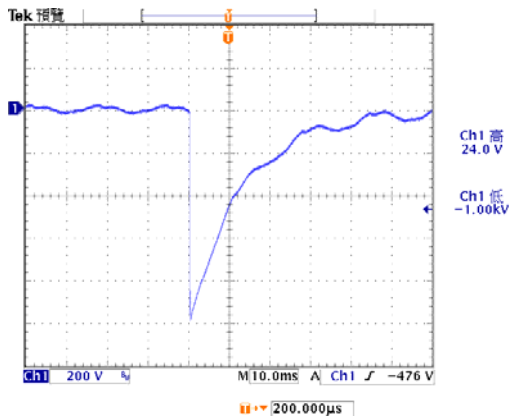

HBM -Voltage Waveform

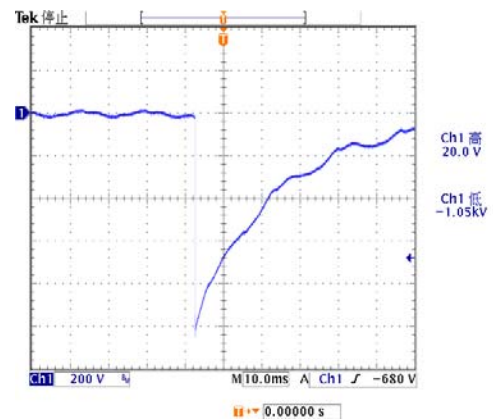

■ TYPICAL CHARACTERISTICS(Cont.)

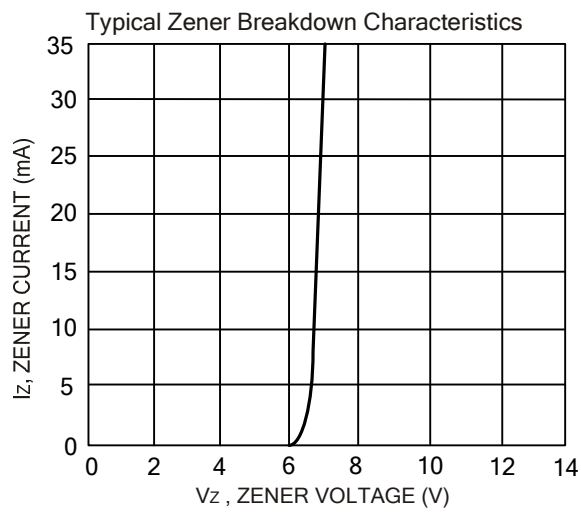
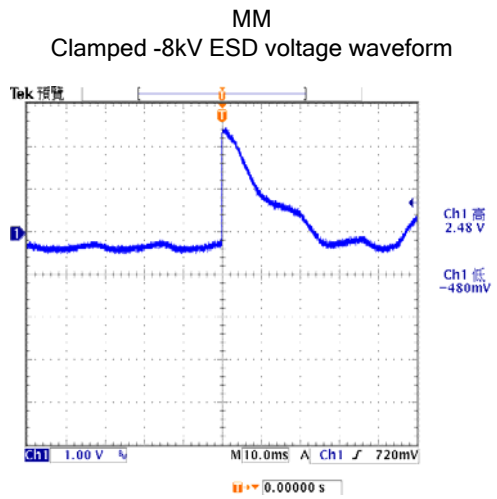
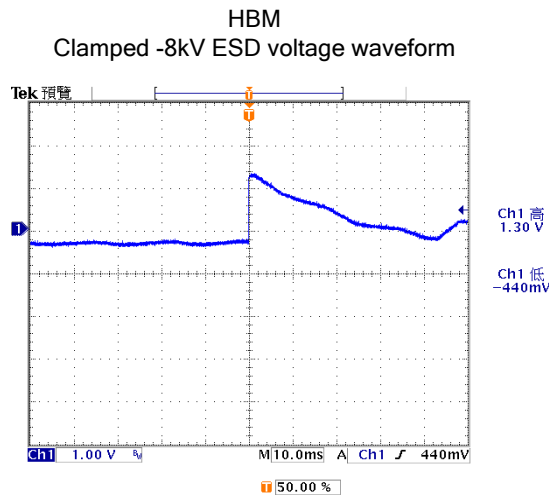
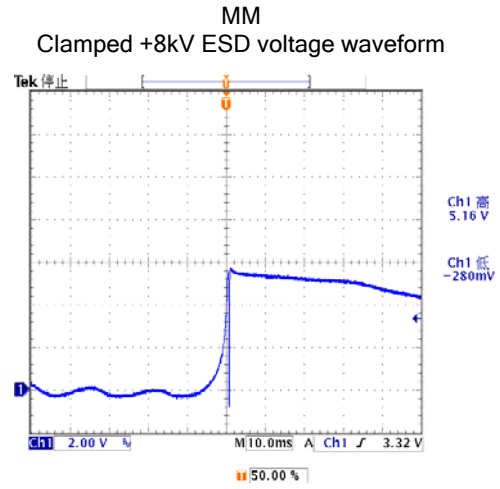
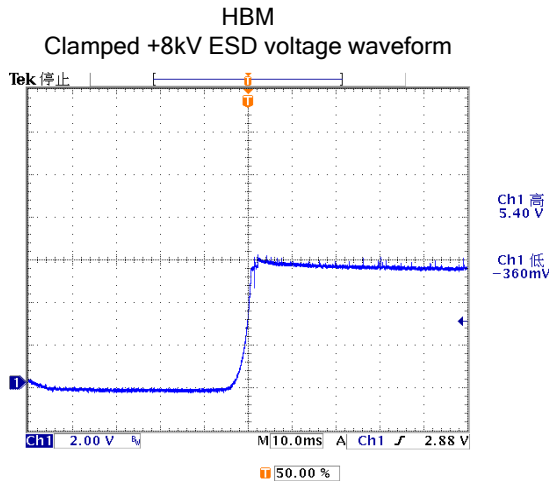

■ TYPICAL CHARACTERISTICS(Cont.)

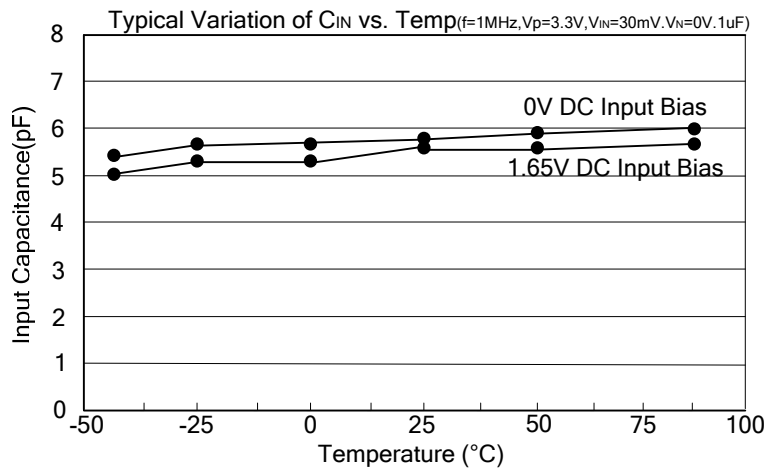
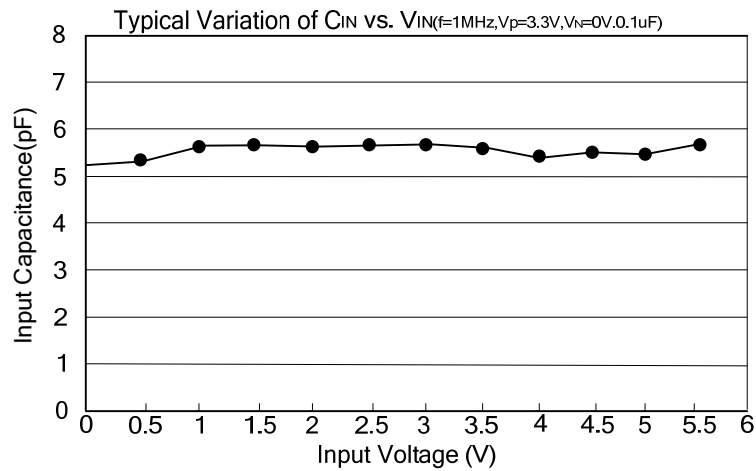

UTC assumes no responsibility for equipment failures that result from using products at values that exceed, even momentarily, rated values (such as maximum ratings, operating condition ranges, or other parameters) listed in products specifications of any and all UTC products described or contained herein. UTC products are not designed for use in life support appliances, devices or systems where malfunction of these products can be reasonably expected to result in personal injury. Reproduction in whole or in part is prohibited without the prior written consent of the copyright owner. The information presented in this document does not form part of any quotation or contract, is believed to be accurate and reliable and may be changed without notice.