

Coaxial Frequency Mixer

Level 7 (LO Power +7 dBm) 10 to 750 MHz

ZFM-1W+



SMA version shown
CASE STYLE: K18

Connectors	Model
BNC	ZFM-1W+
SMA	ZFM-1W-S+
BRACKET (OPTION "B")	

+RoHS Compliant

The +Suffix identifies RoHS Compliance. See our web site for RoHS Compliance methodologies and qualifications

Maximum Ratings

Operating Temperature	-55°C to 100°C
Storage Temperature	-55°C to 100°C
RF Power	50mW
IF Current	40mA
Permanent damage may occur if any of these limits are exceeded.	

Coaxial Connections

LO	1
RF	2
IF	3

Features

- low conversion loss, 5.42 dB typ.
- good L-R isolation, 45 dB typ, L-I, 40 dB typ.
- rugged shielded case

Applications

- VHF/UHF
- defense & federal communications
- instrumentation

Outline Drawing

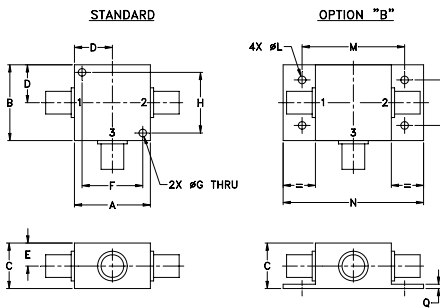

Outline Dimensions (inch/mm)

A	B	C	D	E	F	G	H
1.25	1.25	.75	.63	.38	1.00	.125	1.000
31.75	31.75	19.05	16.00	9.65	25.40	3.18	25.40

J	K	L	M	N	P	Q	wt
--	--	.125	1.688	2.18	.75	.07	grams
--	--	3.18	42.88	55.37	19.05	1.78	70.0

Electrical Specifications

FREQUENCY (MHz)		CONVERSION LOSS (dB)				LO-RF ISOLATION (dB)						LO-IF ISOLATION (dB)					
LO/RF f_L-f_U	IF	Mid-Band m			Total Range Max.	L		M		U		L		M		U	
		\bar{X}	σ	Max.		Typ.	Min.	Typ.	Min.	Typ.	Min.	Typ.	Min.	Typ.	Min.		
10-750	DC-750	5.42	0.14	7.0	8.0	50	45	45	30	35	25	45	40	40	25	27	20

1 dB COMP.: +1 dBm typ. L = low range [f_L to $10 f_L$] M = mid range [$10 f_L$ to $f_U/2$] U = upper range [$f_U/2$ to f_U]
m = mid band [$2f_L$ to $f_U/2$]

Typical Performance Data

Frequency (MHz)		Conversion Loss (dB)	Isolation L-R (dB)	Isolation L-I (dB)	VSWR RF Port (:1)	VSWR LO Port (:1)
RF	LO	LO +7dBm	LO +7dBm	LO +7dBm	LO +7dBm	LO +7dBm
1.00	31.00	6.42	>67.00	>67.00	1.20	3.31
2.00	32.00	5.97	>67.00	>67.00	1.12	3.09
5.00	35.00	5.50	>67.00	>67.00	1.10	3.15
10.00	40.00	5.66	>67.00	>67.00	1.12	2.99
20.00	50.00	5.60	>67.00	>67.00	1.14	2.99
50.00	80.00	5.60	>67.00	62.28	1.16	2.84
100.00	70.00	5.47	>67.00	55.09	1.20	2.88
130.14	100.14	5.52	57.96	51.55	1.23	2.75
200.00	170.00	5.62	50.48	45.84	1.30	2.74
285.11	255.11	5.47	45.61	40.64	1.35	2.74
362.59	332.59	5.71	42.62	37.34	1.40	2.78
414.25	384.25	5.97	40.09	36.21	1.45	2.78
500.00	470.00	6.14	39.49	33.17	1.48	2.80
543.39	513.39	6.24	37.59	31.35	1.50	2.82
595.04	565.04	6.21	37.44	31.39	1.49	2.85
646.70	616.70	6.16	36.31	33.58	1.51	2.93
672.53	642.53	6.27	36.63	31.60	1.58	2.94
698.36	668.36	6.43	36.64	29.86	1.64	3.03
724.18	694.18	6.68	36.68	28.78	1.72	3.01
750.00	720.00	6.98	35.77	27.45	1.83	3.01

Electrical Schematic

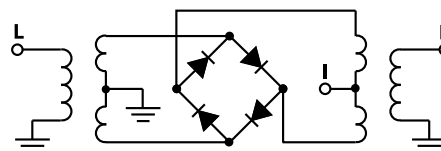

Notes

- Performance and quality attributes and conditions not expressly stated in this specification document are intended to be excluded and do not form a part of this specification document.
- Electrical specifications and performance data contained in this specification document are based on Mini-Circuit's applicable established test performance criteria and measurement instructions.
- The parts covered by this specification document are subject to Mini-Circuit's standard limited warranty and terms and conditions (collectively, "Standard Terms"); Purchasers of this part are entitled to the rights and benefits contained therein. For a full statement of the Standard Terms and the exclusive rights and remedies thereunder, please visit Mini-Circuit's website at www.minicircuits.com/MCLStore/terms.jsp



Performance Charts

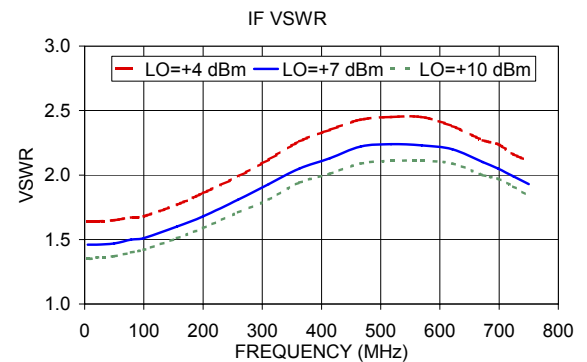
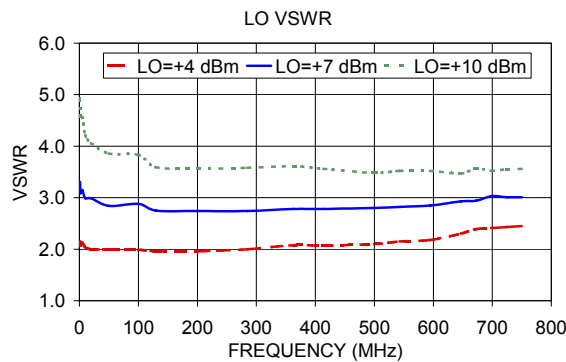
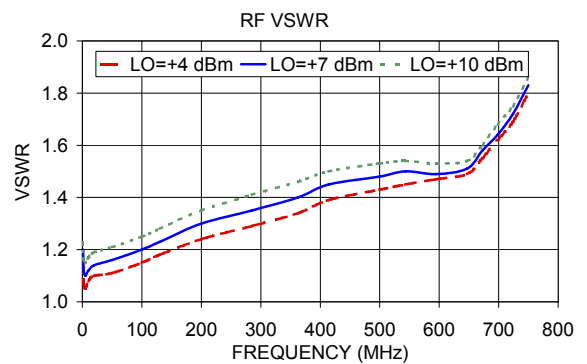
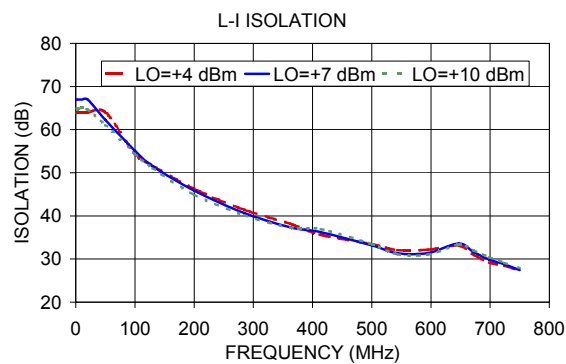
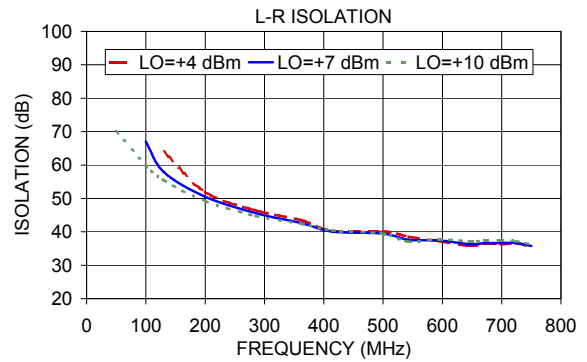
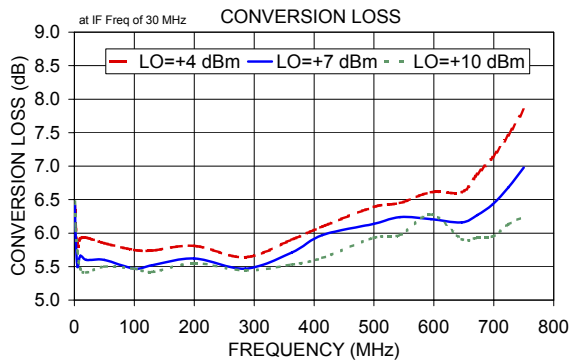

Notes

- A. Performance and quality attributes and conditions not expressly stated in this specification document are intended to be excluded and do not form a part of this specification document.
- B. Electrical specifications and performance data contained in this specification document are based on Mini-Circuit's applicable established test performance criteria and measurement instructions.
- C. The parts covered by this specification document are subject to Mini-Circuits standard limited warranty and terms and conditions (collectively, "Standard Terms"); Purchasers of this part are entitled to the rights and benefits contained therein. For a full statement of the Standard Terms and the exclusive rights and remedies thereunder, please visit Mini-Circuits' website at www.minicircuits.com/MCLStore/terms.jsp

