

P-Channel Enhancement-Mode Vertical DMOS FET

Features

- -2.4V Maximum Low Threshold
- High Input Impedance
- 60 pF Low Input Capacitance
- Fast Switching Speeds
- Low On-Resistance
- Free from Secondary Breakdown
- Low Input and Output Leakage

Applications

- Logic-Level Interfaces (Ideal for TTL and CMOS)
- Solid-State Relays
- Battery-Operated Systems
- Photovoltaic Drives
- Analog Switches
- General Purpose Line Drivers
- Telecommunication Switches

General Description

The TP2535 low-threshold, Enhancement-mode (normally-off) transistor uses a vertical DMOS structure and a well-proven silicon-gate manufacturing process. This combination produces a device with the power handling capabilities of bipolar transistors and the high input impedance and positive temperature coefficient inherent in MOS devices. Characteristic of all MOS structures, this device is free from thermal runaway and thermally induced secondary breakdown.

Microchip's vertical DMOS FETs are ideally suited to a wide range of switching and amplifying applications where very low threshold voltage, high breakdown voltage, high input impedance, low input capacitance, and fast switching speeds are desired.

Package Type

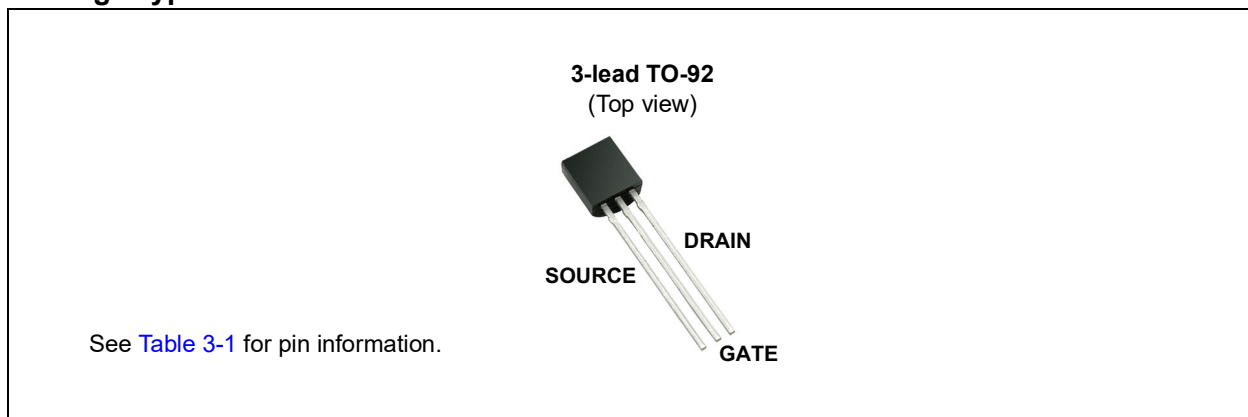

TP2535

1.0 ELECTRICAL CHARACTERISTICS

Absolute Maximum Ratings†

Drain-to-Source Voltage	BV_{DSS}
Drain-to-Gate Voltage	BV_{DGS}
Gate-to-Source Voltage	$\pm 20V$
Operating Ambient Temperature, T_A	$-55^{\circ}C$ to $+150^{\circ}C$
Storage Temperature, T_S	$-55^{\circ}C$ to $+150^{\circ}C$

† **Notice:** Stresses above those listed under “Absolute Maximum Ratings” may cause permanent damage to the device. This is a stress rating only, and functional operation of the device at those or any other conditions above those indicated in the operational sections of this specification is not intended. Exposure to maximum rating conditions for extended periods may affect device reliability.

DC ELECTRICAL CHARACTERISTICS

Electrical Specifications: $T_A = 25^{\circ}C$ unless otherwise specified. All DC parameters are 100% tested at $25^{\circ}C$ unless otherwise stated. Pulse test: 300 μs pulse, 2% duty cycle.

Parameter	Sym.	Min.	Typ.	Max.	Unit	Conditions
Drain-to-Source Breakdown Voltage	BV_{DSS}	-350	—	—	V	$V_{GS} = 0V, I_D = -2\text{ mA}$
Gate Threshold Voltage	$V_{GS(th)}$	-1	—	-2.4	V	$V_{GS} = V_{DS}, I_D = -1\text{ mA}$
Change in $V_{GS(th)}$ with Temperature	$\Delta V_{GS(th)}$	—	—	4.8	mV/ $^{\circ}C$	$V_{GS} = V_{DS}, I_D = -1\text{ mA}$ (Note 1)
Gate Body Leakage Current	I_{GSS}	—	—	-100	nA	$V_{GS} = \pm 20V, V_{DS} = 0V$
Zero-Gate Voltage Drain Current	I_{DSS}	—	—	-10	μA	$V_{GS} = 0V,$ $V_{DS} = \text{Maximum rating}$
		—	—	-1	mA	$V_{DS} = 0.8 \text{ Maximum rating},$ $V_{GS} = 0V, T_A = 125^{\circ}C$ (Note 1)
On-State Drain Current	$I_{D(ON)}$	-0.2	-0.3	—	A	$V_{GS} = -4.5V, V_{DS} = -25V$
		-0.4	-1.1	—	A	$V_{GS} = -10V, V_{DS} = -25V$
Static Drain-to-Source On-State Resistance	$R_{DS(ON)}$	—	20	30	Ω	$V_{GS} = -4.5V, I_D = -100\text{ mA}$
		—	19	25	Ω	$V_{GS} = -10V, I_D = -100\text{ mA}$
Change in $R_{DS(ON)}$ with Temperature	$\Delta R_{DS(ON)}$	—	—	0.75	%/ $^{\circ}C$	$V_{GS} = -10V, I_D = -100\text{ mA}$ (Note 1)

Note 1: Specification is obtained by characterization and is not 100% tested.

AC ELECTRICAL CHARACTERISTICS

Electrical Specifications: $T_A = 25^\circ\text{C}$ unless otherwise specified. Specification is obtained by characterization and is not 100% tested.

Parameter	Sym.	Min.	Typ.	Max.	Unit	Conditions
Forward Transconductance	G_{FS}	100	175	—	mmho	$V_{DS} = -25\text{V}$, $I_D = -100\text{ mA}$
Input Capacitance	C_{ISS}	—	60	125	pF	$V_{GS} = 0\text{V}$, $V_{DS} = -25\text{V}$, $f = 1\text{ MHz}$
Common-Source Output Capacitance	C_{OSS}	—	20	70	pF	
Reverse Transfer Capacitance	C_{RSS}	—	10	25	pF	
Turn-On Delay Time	$t_{d(ON)}$	—	—	10	ns	$V_{DD} = -25\text{V}$, $I_D = -0.4\text{A}$, $R_{GEN} = 25\Omega$
Rise Time	t_r	—	—	10	ns	
Turn-Off Delay Time	$t_{d(OFF)}$	—	—	20	ns	
Fall Time	t_f	—	—	13	ns	

DIODE PARAMETER

Diode Forward Voltage Drop	V_{SD}	—	—	-1.8	V	$V_{GS} = 0\text{V}$, $I_{SD} = -100\text{ mA}$ (Note 1)
Reverse Recovery Time	t_{rr}	—	300	—	ns	$V_{GS} = 0\text{V}$, $I_{SD} = -100\text{ mA}$

Note 1: Unless otherwise stated, all DC parameters are 100% tested at 25°C . Pulse test: 300 μs pulse, 2% duty cycle.

TEMPERATURE SPECIFICATIONS

Parameter	Sym.	Min.	Typ.	Max.	Unit	Conditions
TEMPERATURE RANGE						
Operating Ambient Temperature	T_A	-55	—	+150	$^\circ\text{C}$	
Storage Temperature	T_S	-55	—	+150	$^\circ\text{C}$	
PACKAGE THERMAL RESISTANCE						
3-lead TO-92	θ_{JA}	—	132	—	$^\circ\text{C/W}$	

THERMAL CHARACTERISTICS

Package	I_D (Note 1) (Continuous) (mA)	I_D (Pulsed) (mA)	Power Dissipation at $T_A = 25^\circ\text{C}$ (W)	I_{DR} (Note 1) (mA)	I_{DRM} (mA)
3-lead TO-92	-86	-600	0.74	-86	-600

Note 1: I_D (continuous) is limited by maximum rated T_J .

2.0 TYPICAL PERFORMANCE CURVES

Note: The graphs and tables provided following this note are a statistical summary based on a limited number of samples and are provided for informational purposes only. The performance characteristics listed herein are not tested or guaranteed. In some graphs or tables, the data presented may be outside the specified operating range (e.g. outside specified power supply range) and therefore outside the warranted range.

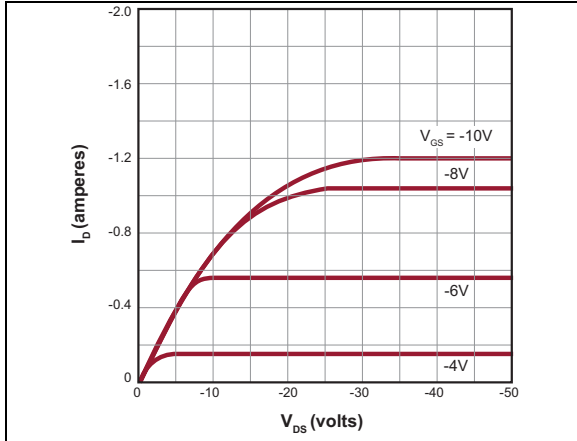

FIGURE 2-1: Output Characteristics.

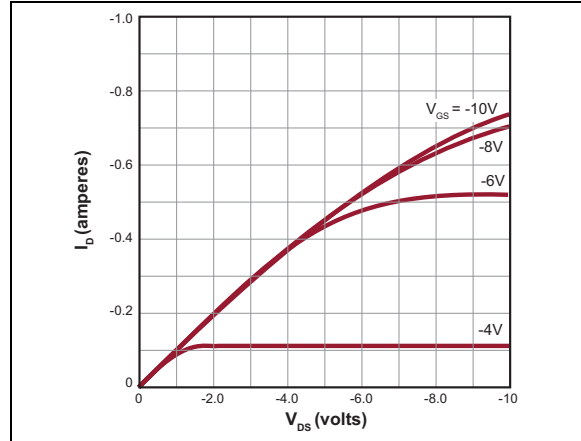

FIGURE 2-4: Saturation Characteristics.

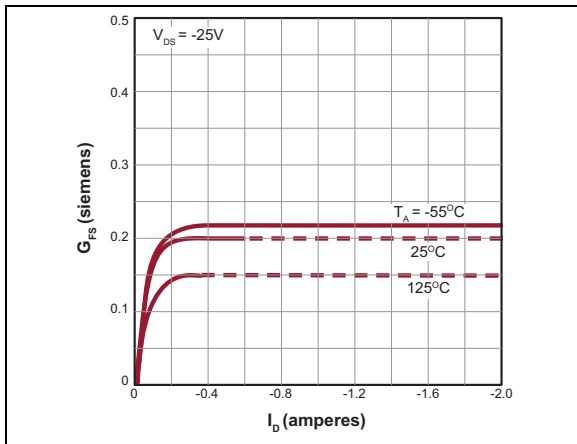

FIGURE 2-2: Transconductance vs. Drain Current.

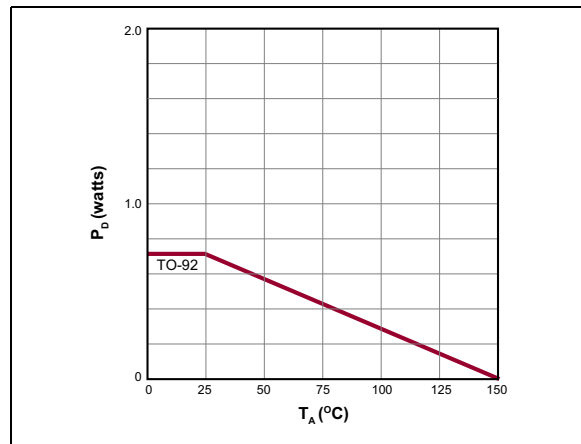

FIGURE 2-5: Power Dissipation vs. Ambient Temperature.

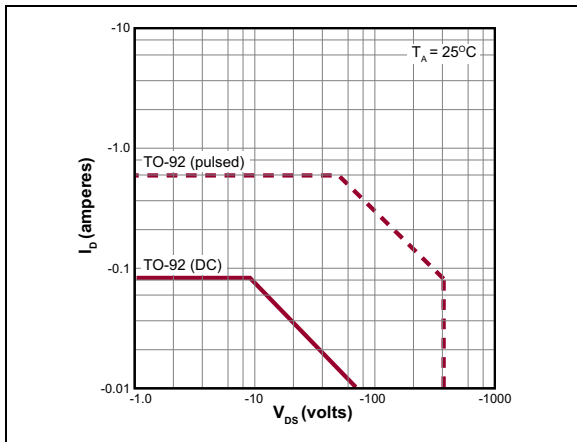

FIGURE 2-3: Maximum Rated Safe Operating Area.

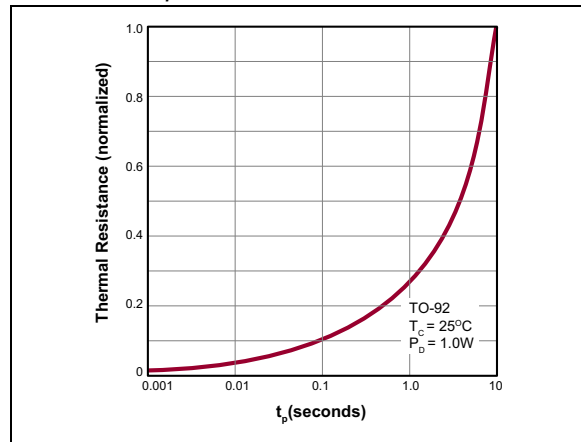

FIGURE 2-6: Thermal Response Characteristics.

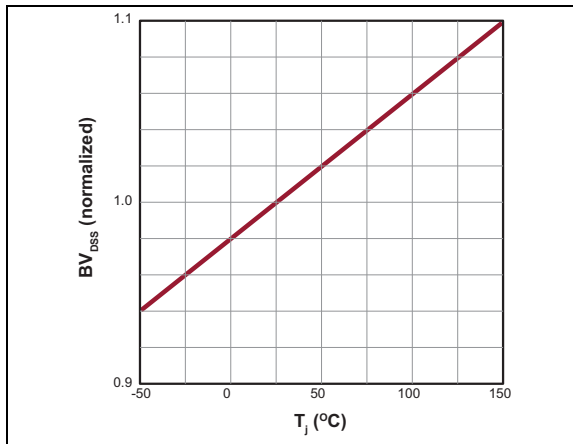

FIGURE 2-7: BV_{DSS} Variation with Temperature.

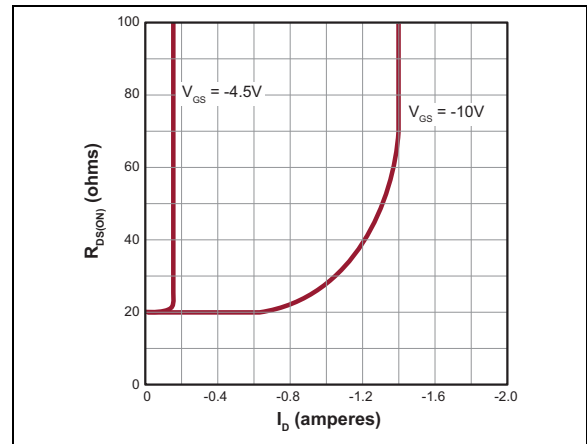

FIGURE 2-10: On-Resistance vs. Drain Current.

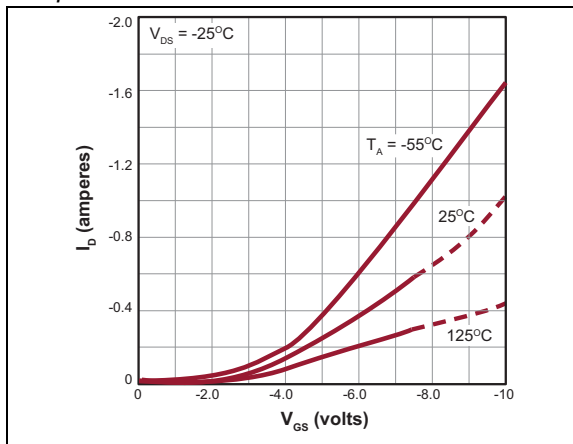

FIGURE 2-8: Transfer Characteristics.

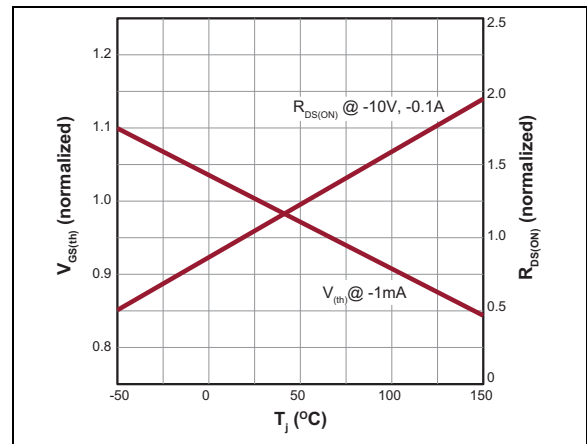

FIGURE 2-11: $V_{(th)}$ and R_{DS} Variation with Temperature.

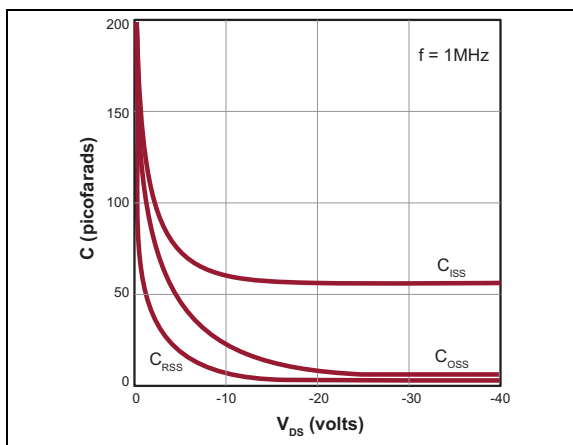

FIGURE 2-9: Capacitance vs. Drain-to-Source Voltage.

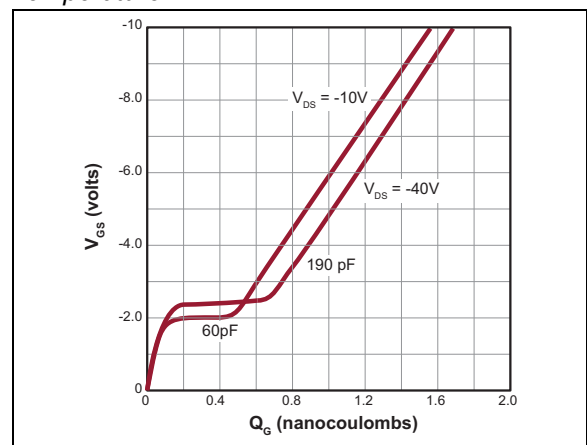

FIGURE 2-12: Gate Drive Dynamic Characteristics.

TP2535

3.0 PIN DESCRIPTION

The details on the pins of TP2535 TO-92 package are listed in [Table 3-1](#). Refer to [Package Type](#) for the location of pins.

TABLE 3-1: TO-92 PIN FUNCTION TABLE

Pin Number	Pin Name	Description
1	Source	Source
2	Gate	Gate
3	Drain	Drain

4.0 FUNCTIONAL DESCRIPTION

Figure 4-1 illustrates the switching waveforms and test circuit for the TP2535.

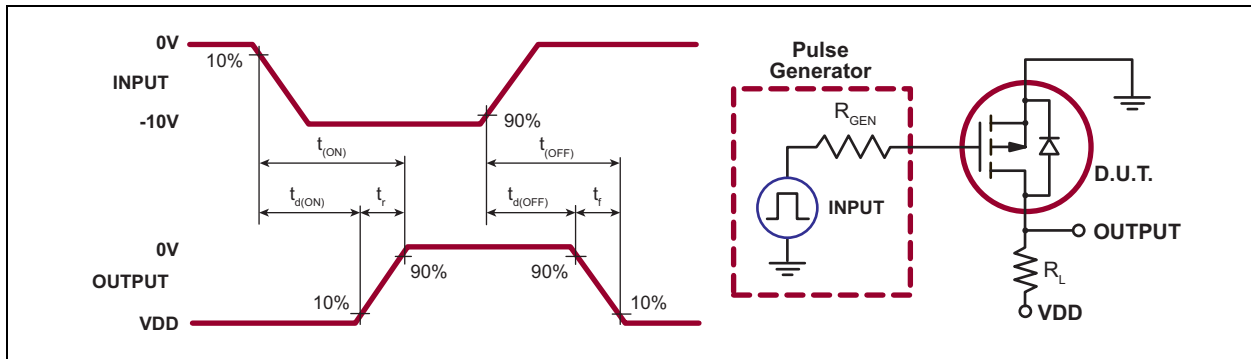

FIGURE 4-1: Switching Waveforms and Test Circuit.

TABLE 4-1: PRODUCT SUMMARY

BV_{DSS}/BV_{DGS} (V)	$R_{DS(ON)}$ (Maximum) (Ω)	$V_{GS(TH)}$ (Maximum) (V)	$I_{D(ON)}$ (Minimum) (A)
-350	25	-0.4	-2.4

TP2535

5.0 PACKAGE MARKING INFORMATION

5.1 Package Marking Information

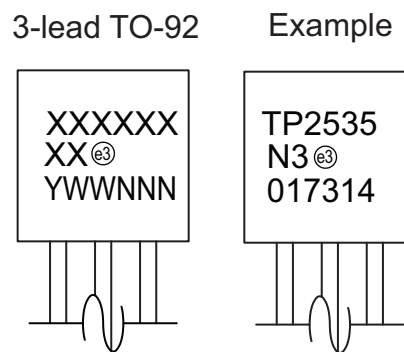

Legend:	XX...X	Product Code or Customer-specific information
	Y	Year code (last digit of calendar year)
	YY	Year code (last 2 digits of calendar year)
	WW	Week code (week of January 1 is week '01')
	NNN	Alphanumeric traceability code
	(e3)	Pb-free JEDEC [®] designator for Matte Tin (Sn)
	*	This package is Pb-free. The Pb-free JEDEC designator (e3) can be found on the outer packaging for this package.

Note: In the event the full Microchip part number cannot be marked on one line, it will be carried over to the next line, thus limiting the number of available characters for product code or customer-specific information. Package may or not include the corporate logo.

3-Lead TO-92 Package Outline (L/LL/N3)

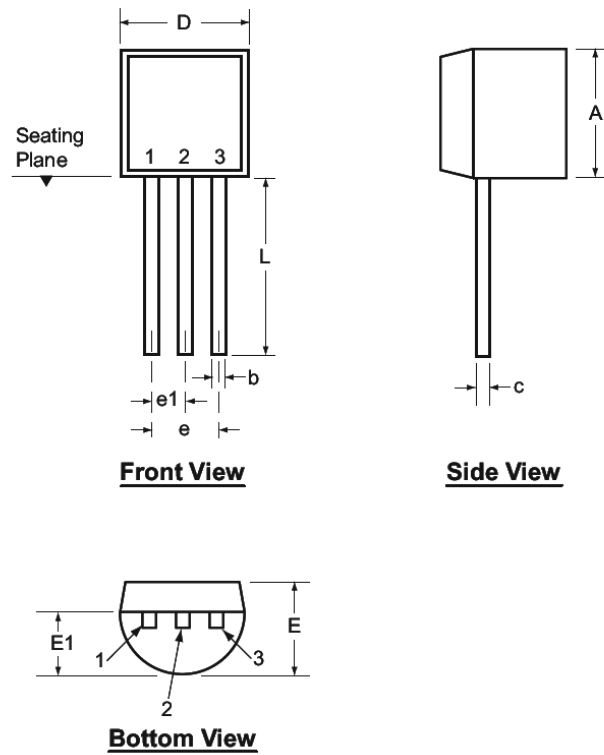

Note: For the most current package drawings, see the Microchip Packaging Specification at www.microchip.com/packaging.

Symbol		A	b	c	D	E	E1	e	e1	L
Dimensions (inches)	MIN	.170	.014 [†]	.014 [†]	.175	.125	.080	.095	.045	.500
	NOM	-	-	-	-	-	-	-	-	-
	MAX	.210	.022 [†]	.022 [†]	.205	.165	.105	.105	.055	.610*

JEDEC Registration TO-92.

* This dimension is not specified in the JEDEC drawing.

† This dimension differs from the JEDEC drawing.

Drawings not to scale.

TP2535

NOTES:

APPENDIX A: REVISION HISTORY

Revision A (June 2020)

- Converted Supertex Doc# DSFP-TP2535 to Microchip DS20005971A
- Added a pin function table
- Changed the package marking format
- Removed the 3-Lead TO-92 N3 P003, P005, P013, and P014 media types
- Made minor text changes throughout the document

TP2535

PRODUCT IDENTIFICATION SYSTEM

To order or obtain information, e.g., on pricing or delivery, contact your local Microchip representative or sales office.

<u>PART NO.</u>	<u>XX</u>	-	<u>X</u>	-	<u>X</u>
Device	Package Options		Environmental		Media Type
Device:	TP2535	=	P-Channel Enhancement-Mode Vertical DMOS FET		
Package:	N3	=	3-lead TO-92		
Environmental:	G	=	Lead (Pb)-free/RoHS-compliant Package		
Media Type:	(blank)	=	1000/Bag for an N3 Package		

Example:

a) TP2535N3-G: P-Channel Enhancement-Mode, Vertical DMOS FET, 3-lead TO-92, 1000/Bag

Note the following details of the code protection feature on Microchip devices:

- Microchip products meet the specification contained in their particular Microchip Data Sheet.
- Microchip believes that its family of products is one of the most secure families of its kind on the market today, when used in the intended manner and under normal conditions.
- There are dishonest and possibly illegal methods used to breach the code protection feature. All of these methods, to our knowledge, require using the Microchip products in a manner outside the operating specifications contained in Microchip's Data Sheets. Most likely, the person doing so is engaged in theft of intellectual property.
- Microchip is willing to work with the customer who is concerned about the integrity of their code.
- Neither Microchip nor any other semiconductor manufacturer can guarantee the security of their code. Code protection does not mean that we are guaranteeing the product as “unbreakable.”

Code protection is constantly evolving. We at Microchip are committed to continuously improving the code protection features of our products. Attempts to break Microchip's code protection feature may be a violation of the Digital Millennium Copyright Act. If such acts allow unauthorized access to your software or other copyrighted work, you may have a right to sue for relief under that Act.

Information contained in this publication regarding device applications and the like is provided only for your convenience and may be superseded by updates. It is your responsibility to ensure that your application meets with your specifications. MICROCHIP MAKES NO REPRESENTATIONS OR WARRANTIES OF ANY KIND WHETHER EXPRESS OR IMPLIED, WRITTEN OR ORAL, STATUTORY OR OTHERWISE, RELATED TO THE INFORMATION, INCLUDING BUT NOT LIMITED TO ITS CONDITION, QUALITY, PERFORMANCE, MERCHANTABILITY OR FITNESS FOR PURPOSE. Microchip disclaims all liability arising from this information and its use. Use of Microchip devices in life support and/or safety applications is entirely at the buyer's risk, and the buyer agrees to defend, indemnify and hold harmless Microchip from any and all damages, claims, suits, or expenses resulting from such use. No licenses are conveyed, implicitly or otherwise, under any Microchip intellectual property rights unless otherwise stated.

Trademarks

The Microchip name and logo, the Microchip logo, Adaptec, AnyRate, AVR, AVR logo, AVR Freaks, BesTime, BitCloud, chipKIT, chipKIT logo, CryptoMemory, CryptoRF, dsPIC, FlashFlex, flexPWR, HELDO, IGLoo, JukeBlox, KeeLoq, Klear, LANCheck, LinkMD, maXStylus, maXTouch, MediaLB, megaAVR, Microsemi, Microsemi logo, MOST, MOST logo, MPLAB, OptoLyzer, PackeTime, PIC, picoPower, PICSTART, PIC32 logo, PolarFire, Prochip Designer, QTouch, SAM-BA, SenGenuity, SpyNIC, SST, SST Logo, SuperFlash, Symmetricom, SyncServer, Tachyon, TempTrackr, TimeSource, tinyAVR, UNI/O, Vectron, and XMEGA are registered trademarks of Microchip Technology Incorporated in the U.S.A. and other countries.

APT, ClockWorks, The Embedded Control Solutions Company, EtherSynch, FlashTec, Hyper Speed Control, HyperLight Load, IntelliMOS, Libero, motorBench, mTouch, Powermite 3, Precision Edge, ProASIC, ProASIC Plus, ProASIC Plus logo, Quiet-Wire, SmartFusion, SyncWorld, Temux, TimeCesium, TimeHub, TimePictra, TimeProvider, Vite, WinPath, and ZL are registered trademarks of Microchip Technology Incorporated in the U.S.A.

Adjacent Key Suppression, AKS, Analog-for-the-Digital Age, Any Capacitor, AnyIn, AnyOut, BlueSky, BodyCom, CodeGuard, CryptoAuthentication, CryptoAutomotive, CryptoCompanion, CryptoController, dsPICDEM, dsPICDEM.net, Dynamic Average Matching, DAM, ECAN, EtherGREEN, In-Circuit Serial Programming, ICSP, INICnet, Inter-Chip Connectivity, JitterBlocker, KlearNet, KlearNet logo, memBrain, Mindi, MiWi, MPASM, MPF, MPLAB Certified logo, MPLIB, MPLINK, MultiTRAK, NetDetach, Omniscient Code Generation, PICDEM, PICDEM.net, PICkit, PICtail, PowerSmart, PureSilicon, QMatrix, REAL ICE, Ripple Blocker, SAM-ICE, Serial Quad I/O, SMART-I.S., SQI, SuperSwitcher, SuperSwitcher II, Total Endurance, TSHARC, USBCheck, VariSense, ViewSpan, WiperLock, Wireless DNA, and ZENA are trademarks of Microchip Technology Incorporated in the U.S.A. and other countries.

SQTP is a service mark of Microchip Technology Incorporated in the U.S.A.

The Adaptec logo, Frequency on Demand, Silicon Storage Technology, and Symmcom are registered trademarks of Microchip Technology Inc. in other countries.

GestIC is a registered trademark of Microchip Technology Germany II GmbH & Co. KG, a subsidiary of Microchip Technology Inc., in other countries.

All other trademarks mentioned herein are property of their respective companies.

© 2020, Microchip Technology Incorporated, All Rights Reserved.

For information regarding Microchip's Quality Management Systems, please visit www.microchip.com/quality.

ISBN:978-1-5224-6257-6



MICROCHIP

Worldwide Sales and Service

AMERICAS

Corporate Office
2355 West Chandler Blvd.
Chandler, AZ 85224-6199
Tel: 480-792-7200
Fax: 480-792-7277
Technical Support:
<http://www.microchip.com/support>
Web Address:
www.microchip.com

Atlanta
Duluth, GA
Tel: 678-957-9614
Fax: 678-957-1455

Austin, TX
Tel: 512-257-3370

Boston
Westborough, MA
Tel: 774-760-0087
Fax: 774-760-0088

Chicago
Itasca, IL
Tel: 630-285-0071
Fax: 630-285-0075

Dallas
Addison, TX
Tel: 972-818-7423
Fax: 972-818-2924

Detroit
Novi, MI
Tel: 248-848-4000

Houston, TX
Tel: 281-894-5983

Indianapolis
Noblesville, IN
Tel: 317-773-8323
Fax: 317-773-5453
Tel: 317-536-2380

Los Angeles
Mission Viejo, CA
Tel: 949-462-9523
Fax: 949-462-9608
Tel: 951-273-7800

Raleigh, NC
Tel: 919-844-7510

New York, NY
Tel: 631-435-6000

San Jose, CA
Tel: 408-735-9110
Tel: 408-436-4270

Canada - Toronto
Tel: 905-695-1980
Fax: 905-695-2078

ASIA/PACIFIC

Australia - Sydney
Tel: 61-2-9868-6733

China - Beijing
Tel: 86-10-8569-7000

China - Chengdu
Tel: 86-28-8665-5511

China - Chongqing
Tel: 86-23-8980-9588

China - Dongguan
Tel: 86-769-8702-9880

China - Guangzhou
Tel: 86-20-8755-8029

China - Hangzhou
Tel: 86-571-8792-8115

China - Hong Kong SAR
Tel: 852-2943-5100

China - Nanjing
Tel: 86-25-8473-2460

China - Qingdao
Tel: 86-532-8502-7355

China - Shanghai
Tel: 86-21-3326-8000

China - Shenyang
Tel: 86-24-2334-2829

China - Shenzhen
Tel: 86-755-8864-2200

China - Suzhou
Tel: 86-186-6233-1526

China - Wuhan
Tel: 86-27-5980-5300

China - Xian
Tel: 86-29-8833-7252

China - Xiamen
Tel: 86-592-2388138

China - Zhuhai
Tel: 86-756-3210040

ASIA/PACIFIC

India - Bangalore
Tel: 91-80-3090-4444

India - New Delhi
Tel: 91-11-4160-8631

India - Pune
Tel: 91-20-4121-0141

Japan - Osaka
Tel: 81-6-6152-7160

Japan - Tokyo
Tel: 81-3-6880-3770

Korea - Daegu
Tel: 82-53-744-4301

Korea - Seoul
Tel: 82-2-554-7200

Malaysia - Kuala Lumpur
Tel: 60-3-7651-7906

Malaysia - Penang
Tel: 60-4-227-8870

Philippines - Manila
Tel: 63-2-634-9065

Singapore
Tel: 65-6334-8870

Taiwan - Hsin Chu
Tel: 886-3-577-8366

Taiwan - Kaohsiung
Tel: 886-7-213-7830

Taiwan - Taipei
Tel: 886-2-2508-8600

Thailand - Bangkok
Tel: 66-2-694-1351

Vietnam - Ho Chi Minh
Tel: 84-28-5448-2100

EUROPE

Austria - Wels
Tel: 43-7242-2244-39
Fax: 43-7242-2244-393

Denmark - Copenhagen
Tel: 45-4485-5910
Fax: 45-4485-2829

Finland - Espoo
Tel: 358-9-4520-820

France - Paris
Tel: 33-1-69-53-63-20
Fax: 33-1-69-30-90-79

Germany - Garching
Tel: 49-8931-9700

Germany - Haan
Tel: 49-2129-3766400

Germany - Heilbronn
Tel: 49-7131-72400

Germany - Karlsruhe
Tel: 49-721-625370

Germany - Munich
Tel: 49-89-627-144-0
Fax: 49-89-627-144-44

Germany - Rosenheim
Tel: 49-8031-354-560

Israel - Ra'anana
Tel: 972-9-744-7705

Italy - Milan
Tel: 39-0331-742611
Fax: 39-0331-466781

Italy - Padova
Tel: 39-049-7625286

Netherlands - Drunen
Tel: 31-416-690399
Fax: 31-416-690340

Norway - Trondheim
Tel: 47-7288-4388

Poland - Warsaw
Tel: 48-22-3325737

Romania - Bucharest
Tel: 40-21-407-87-50

Spain - Madrid
Tel: 34-91-708-08-90
Fax: 34-91-708-08-91

Sweden - Gothenberg
Tel: 46-31-704-60-40

Sweden - Stockholm
Tel: 46-8-5090-4654

UK - Wokingham
Tel: 44-118-921-5800
Fax: 44-118-921-5820