

TAT6254C

Fiber To The Home RF Amplifier 47–1000 MHz



Applications

- High dynamic range FTTH
- GPON FTTH
- Multi Dwelling Unit TIA
- Mini-node



Product Features

- Single 12 V or 5 V configuration
- Low Noise 3.9 pA/rtHz Equivalent Input Noise
- 19 or 23 dBmV/channel RF output, at 55.25MHz
- 33 dB AGC range, for -10 to +2 dBm optical inputs
- Low power consumption, 1.3 Watts at 12 V and 1.0 Watt at 5 V
- Potentially eliminates the need for costly balun and directional coupler
- Linearity better than -63 dBc CSO and CTB

General Description

The TriQuint TAT6254C FTTP SFU Video Receiver provides a low noise analog interface to CATV receivers and optical triplexers. The TAT6254C is intended for use in single family unit (SFU) analog video fiber to the premise (FTTP) applications.

The TAT6254C exhibits low input noise and distortion that provides performance margin critical to meeting stringent FTTP link requirements. It runs on either a single 12 V or 5 V supply, eliminating the need for an extra ONU power supply. The TAT6254C provides automatic gain control (AGC) to maintain a constant +19 dBmV/ch output (+23 dBmV in high output mode) to ensure consistent video quality and ease of design. The TAT6254C is fabricated using 6-inch GaAs pHEMT technology to optimize performance and cost.

The TAT6254C has the flexibility to be designed for a range of RF outputs and supply voltages. This datasheet discusses four configurations; standard RF output and high RF output with both 5V and 12V supplies.

Functional Block Diagram

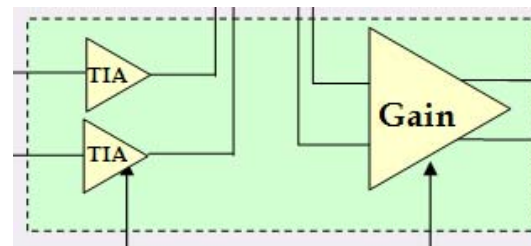

Pin Configuration

Pin #	Symbol
1	TIA IN A
2,4	BIAS 1
3,13	NC
5	TIA IN B
6	BIAS ADJ B
7	TIA OUT B
8, 18	BIAS 2
9	PA IN B
10	TRIM B
11, 12	PA OUT B
14, 15	PA OUT A
16	TRIM A
17	PA IN A
19	TIA OUT A
20	BIAS ADJ A
EPAD	GND

Ordering Information

Part No.	Description
TAT6254C	CATV FTTH pHEMT amplifier
TAT6254C-EB	Evaluation Board

Standard T/R size = 2500 pieces on a 13" reel.

TAT6254C

Fiber To The Home RF Amplifier 47–1000 MHz



Specifications

Absolute Maximum Ratings

Parameter	Rating
Storage Temperature	-60 to +150 °C
Operating Temperature	-40 to +85 °C
Device Voltage, V_{DD}	+15 V
Thermal Resistance (jnc. to case) θ_{jc}	17 °C/W

Operation of this device outside the parameter ranges given above may cause permanent damage.

Recommended Operating Conditions

Parameter	Min	Typ	Max	Units
V_{DD}		12		V
T_J (for $>10^6$ hours MTF)			150	°C

Electrical specifications are measured at specified test conditions. Specifications are not guaranteed over all recommended operating conditions.

Electrical Specifications

(Per Applications Circuit Herein)

Parameter	Conditions	Min	Typical	Max	Units
Operational Frequency Range		47		1000	MHz
RF Gain at 553.25 MHz	See Note 1.		33		dB
Gain Flatness			1.0		dB
Tilt	See Note 2.		3		dB
Equivalent Input Noise			3.9		pA/rtHz
RF Output Level @ 55.25 MHz, Standard Output	See Note 3.	18	19		dBmV/ch
RF Output Level @ 55.25 MHz, High Output	See Notes 3 & 5.	22	23		dBmV/ch
Output Return Loss			16		dB
CSO	See Note 4.		-63		dBc
CTB	See Note 4.		-63		dBc
Gain Control Range	See Note 6.		33		dB
Power Supply Current @ 12 V			120		mA
Power Supply Current @ 5 V			200		mA

- Gain = $20 \cdot \log(Z/75)$
- From 54 MHz to 870 MHz; higher tilt possible
- AGC using 3.3 %/ch output level fixed by external AGC
- 80 channels analog NTSC
- Uses output transformer
- With suggested application circuit

Optical Input and Triplexer Requirements

Parameter	Conditions	Min	Typical	Max	Units
Optical Input Power		-10		2	dBm
Optical Modulation Index			3.3		%/ch
Triplexer 1550 nm PIN Responsivity				0.9	mA/mW
Triplexer 1550 nm PIN Capacitance				0.9	pF

TAT6254C

Fiber To The Home RF Amplifier 47–1000 MHz



12 V Standard Output Application Board Typical Performance

$V_{DD} = +12\text{ V}$, $I_{DD} = 120\text{ mA}$, Temperatures are ambient

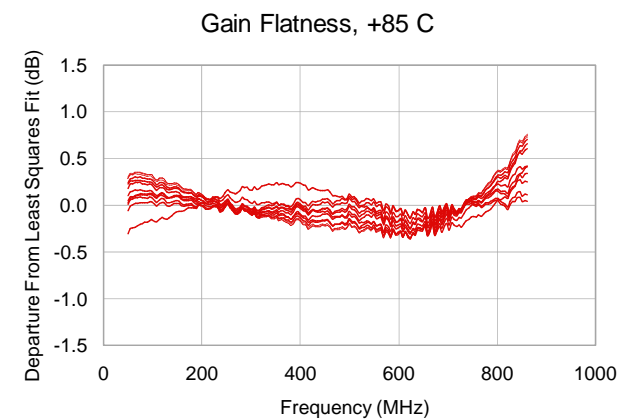
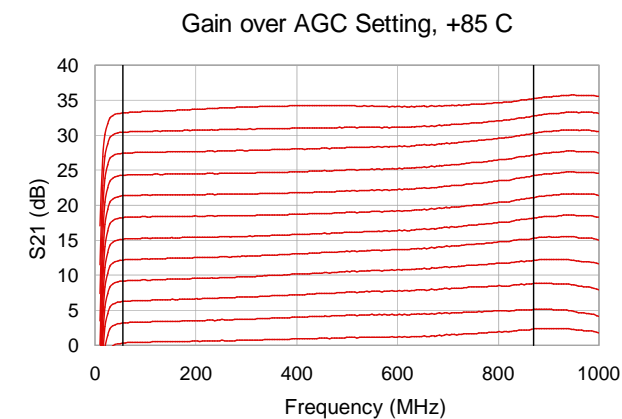
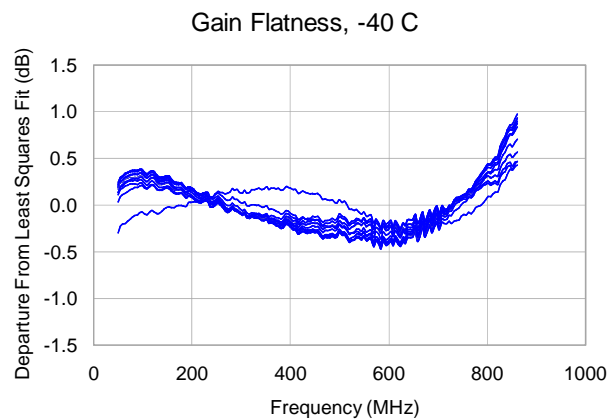
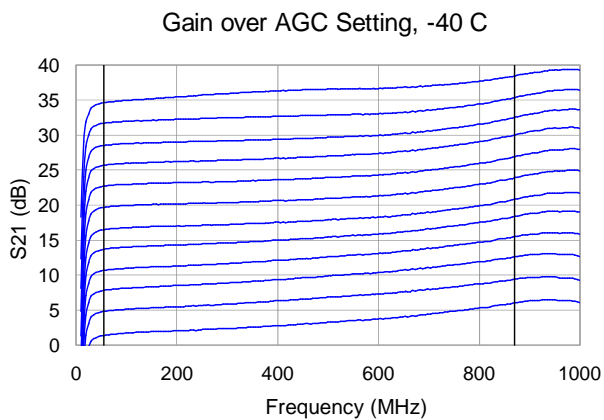
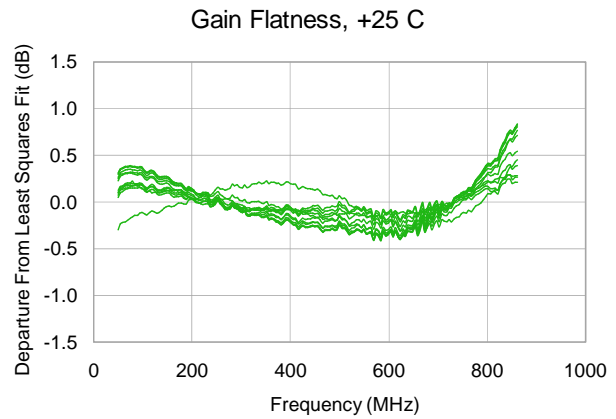
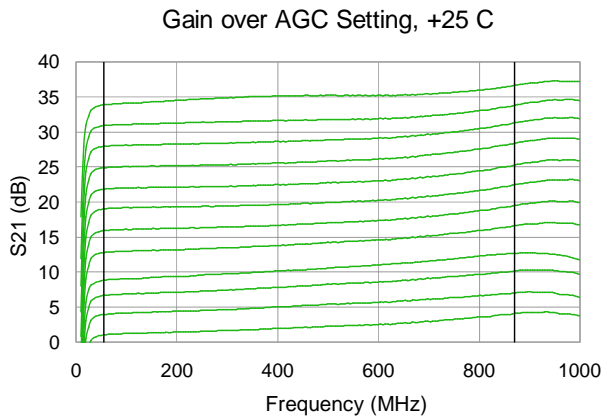

TAT6254C

Fiber To The Home RF Amplifier 47–1000 MHz



12 V Standard Output Application Board Typical Performance (cont'd)

$V_{DD} = +12\text{ V}$, $I_{DD} = 120\text{ mA}$, $25\text{ }^\circ\text{C}$ unless otherwise stated, Temperatures are ambient

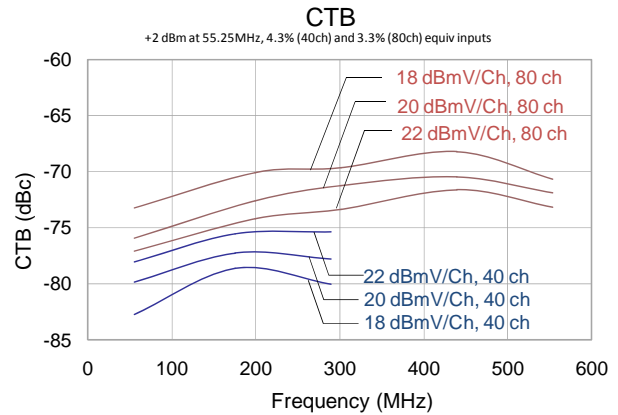
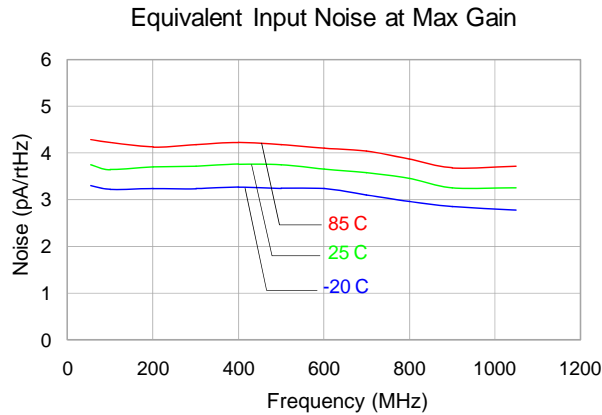

For performance data using 5 V Output, please email sjapplication.engineering@tqs.com.

Detailed Device Description And Application Overview

The TAT6254C integrates two low noise high gain trans-impedance amplifiers in a differential configuration followed by an output amplifier. It provides a low input impedance to minimize the effects of photodiode capacitances and stray impedance affects on gain flatness.

The TAT6254C is fabricated using high gain Gallium Arsenide pHEMT technology developed for high-volume commercial markets. It provides improved gain and noise compared to older MESFET technologies and lower gain pHEMT technologies.

The TAT6254C was designed as a general purpose FTTP receiver. While it eliminates the need for costly hand-wound parts such as baluns and directional couplers, it allows users wide flexibility in setting gain, tilt, and bias levels to best meet the requirements posed by different operators and architectures. The TAT6254C provides the flexibility to address high levels of gain required by GPON architectures. Designers can easily modify external circuit values to enable wider optical input ranges, such as needed in newer GPON architectures.

The TAT6254C provides two high level outputs. One output drives an optical tilt network while the other drives a content filter and an RF detection circuit. The TAT6254C does not require an output balun. Because the two equal outputs have a high level of isolation; the TAT6254C effectively provides an integrated directional coupler with extra gain to drive the RF detection circuit at a high level. This eases offset voltage requirements on operational amplifiers used in the AGC block.

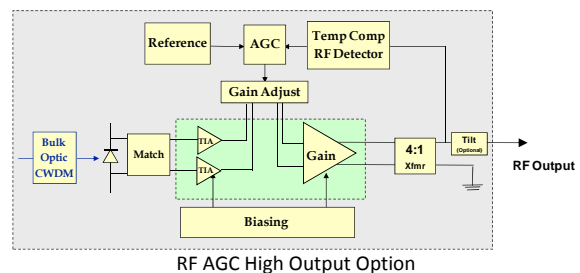
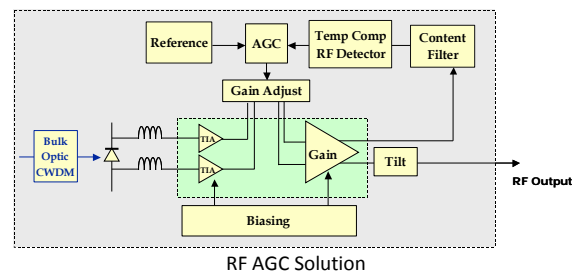

TAT6254C

Fiber To The Home RF Amplifier 47–1000 MHz



Gain control is accommodated with a low cost external PIN diode circuit placed between the input trans-impedance amplifier and the output amplifier. This helps reduce the die size of the TAT6254C and provides for excellent PIN diode distortion characteristics over a continuous control range.

Up to 33 dB of gain control is possible using the recommended 12 V standard output application circuit.

The application circuits are optimized for 870 MHz performance with slight rolloff for use in combination with a post filter for applications such as MoCA. For optimized performance at 1 GHz and beyond, it is recommended that a low capacitance photodiode be used with a change in value of the peaking inductors L1 and L2. For further guidance, please contact TriQuint Semiconductor Application Engineering.

For high output operation, refer to the appropriate 5 V high output application circuit. This option uses a 4:1 transformer to combine the outputs of the second stage.

For further information email sjapplication.engineering@tqs.com.

Pin Description

Pin	Symbol	Description
1	TIA IN A	Input to trans-impedance amplifier A
2,4	BIAS 1	Bias Port
3,13	NC	No Connect
5	TIA IN B	Input to trans-impedance amplifier B
6	BIAS ADJ B	Bias adjustment for trans-impedance amplifier B
7	TIA OUT B	Output of trans-impedance amplifier B
8, 18	BIAS 2	Bias port
9	PA IN B	Input to post-amplifier B
11, 12	PA OUT B	Output of post amplifier B
14, 15	PA OUT A	Output of post amplifier A
17	PA IN A	Input to post amplifier A
19	TIA OUT A	Output of trans-impedance amplifier A
20	BIAS ADJ A	Bias adjustment for trans-impedance amplifier A
EPAD	GND	Ground

TAT6254C

Fiber To The Home RF Amplifier 47–1000 MHz



12 V High Output Schematic

TAT6254C
EVAL 12V
HIGH OUTPUT
50-0002
MPC July 6, 2011

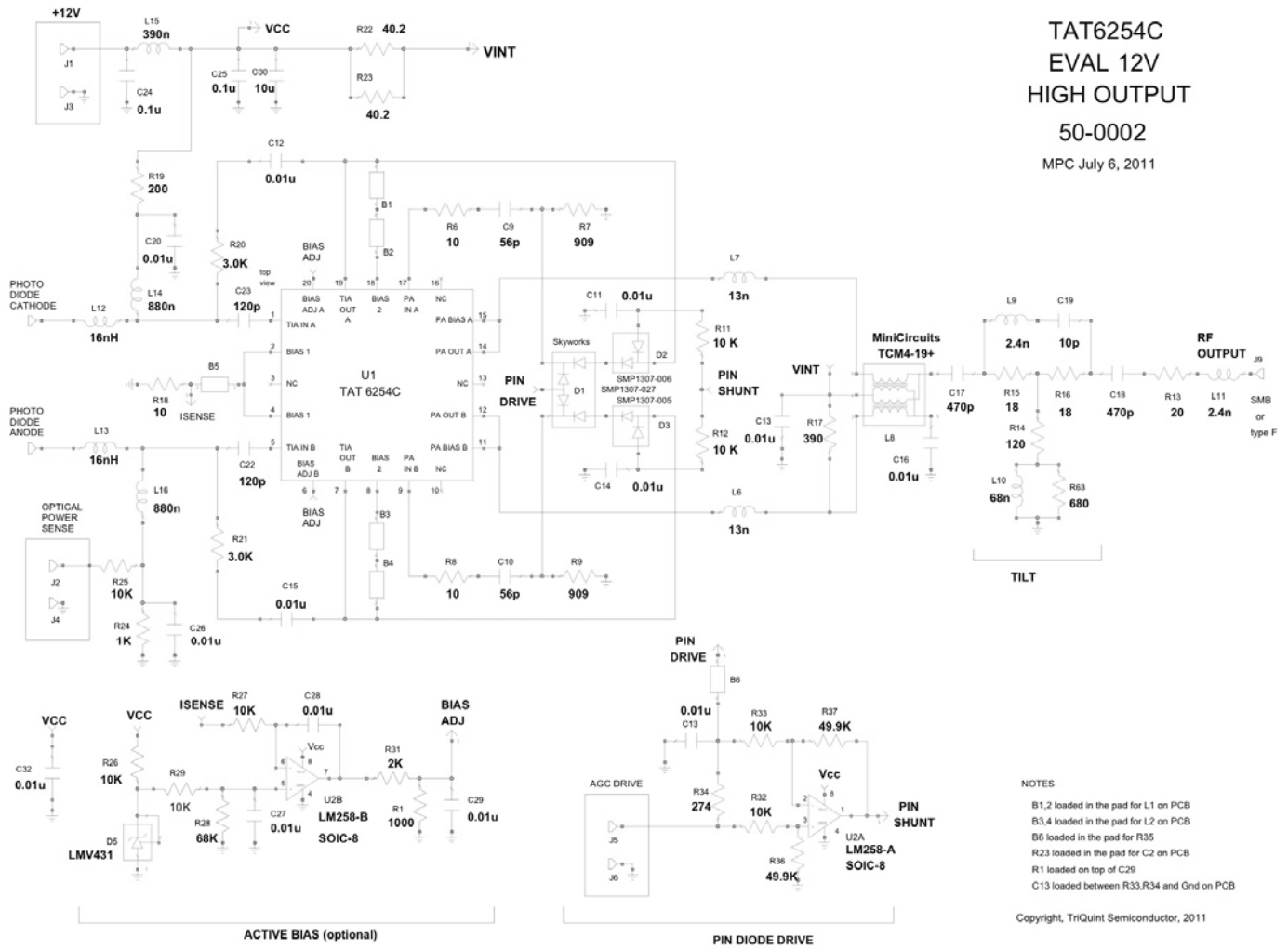

NOTES
B1,2 loaded in the pad for L1 on PCB
B3,4 loaded in the pad for L2 on PCB
B6 loaded in the pad for R35
R23 loaded in the pad for C2 on PCB
R1 loaded on top of C29
C13 loaded between R33,R34 and Gnd on PCB

Copyright, TriQuint Semiconductor, 2011

TAT6254C

Fiber To The Home RF Amplifier 47–1000 MHz



5 V High Output Schematic

TAT6254C Reference Design

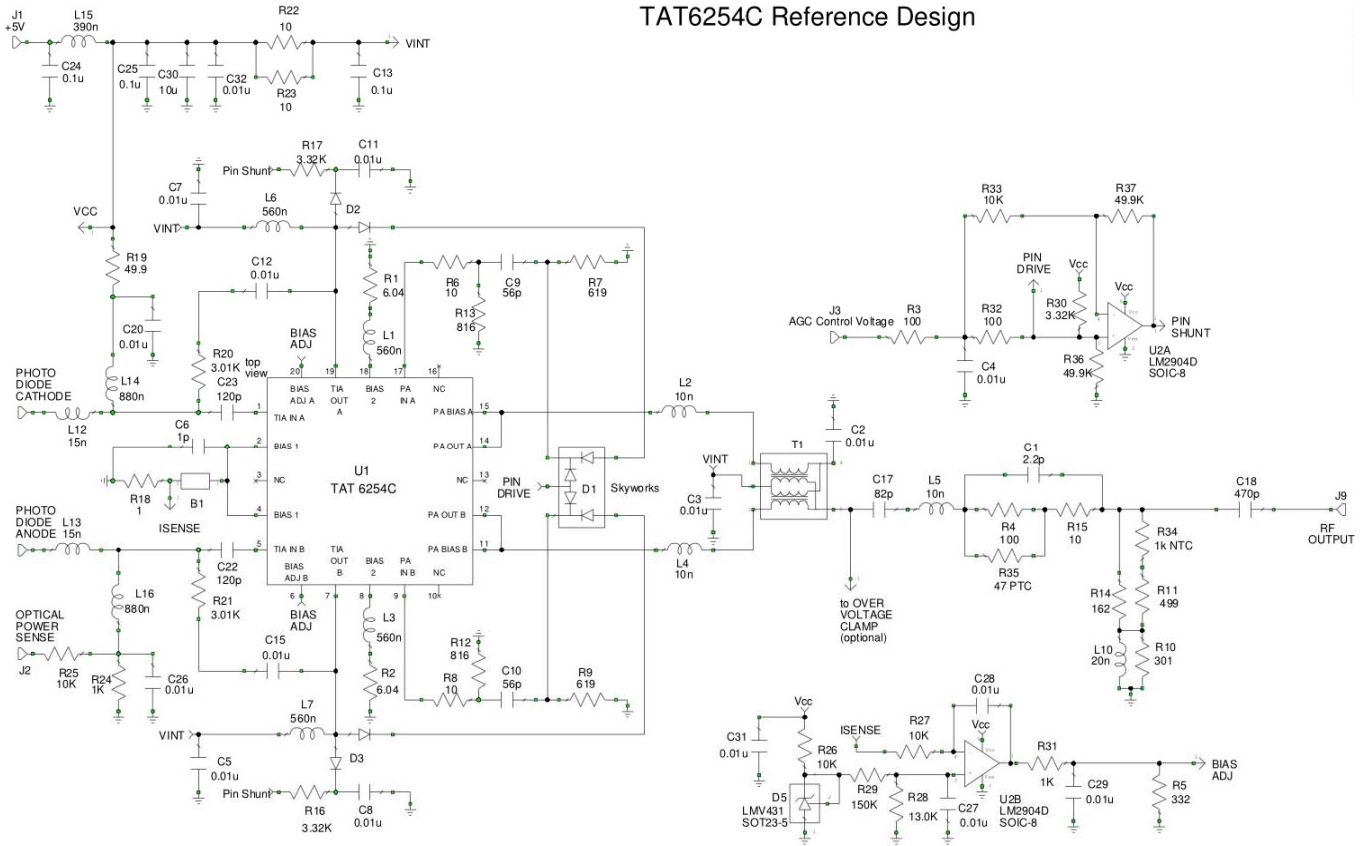

Copyright, TriAccess Technologies, 2008

TAT6254C

Fiber To The Home RF Amplifier 47–1000 MHz



Mechanical Information

Package Information and Dimensions

This package is lead-free/RoHS-compliant. It is compatible with both lead-free (maximum 260 °C reflow temperature) and lead (maximum 245 °C reflow temperature) soldering processes.

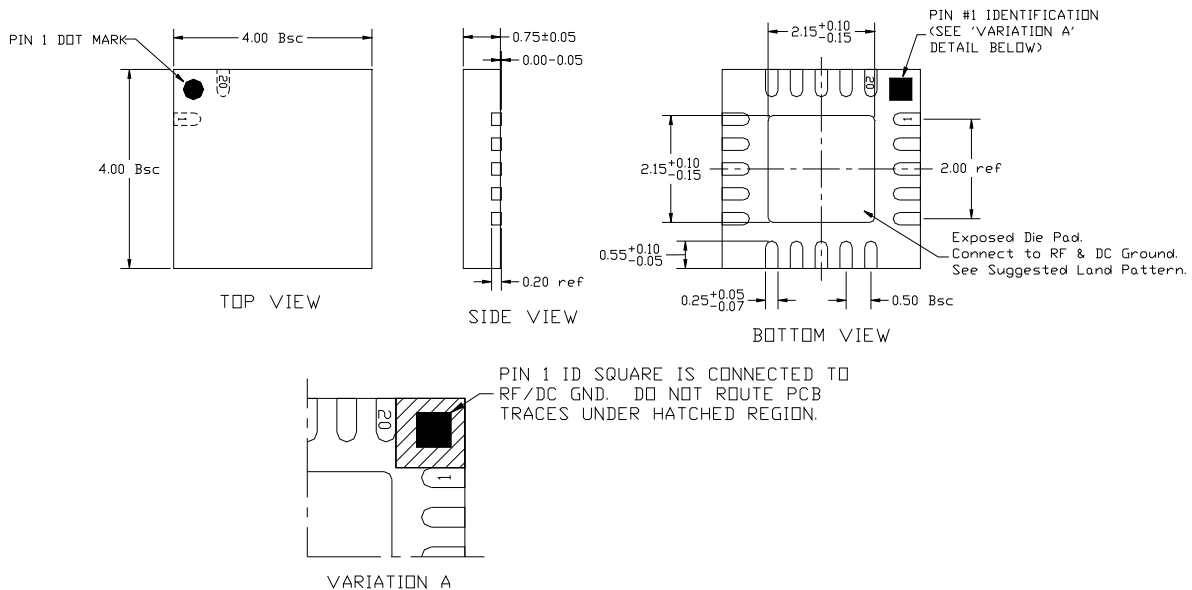

Pin #1 Identification Detail

Mounting Configuration

All dimensions are in millimeters. Angles are in degrees.

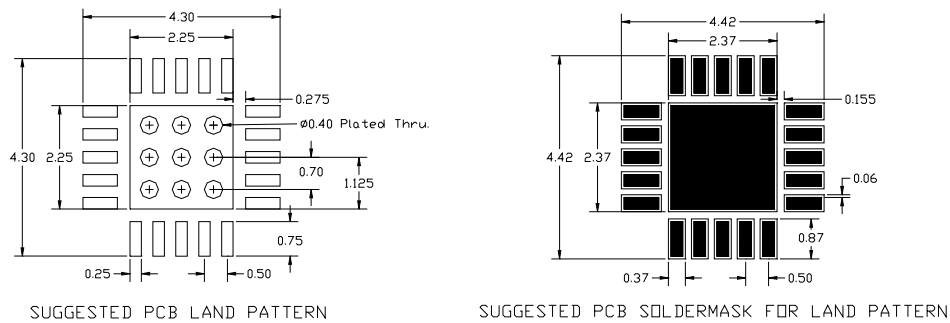

TAT6254C

Fiber To The Home RF Amplifier 47–1000 MHz



Product Compliance Information

ESD Information



Caution! ESD-Sensitive Device

ESD Rating: Class 1A
Value: Passes ≥ 250 V min.
Test: Human Body Model (HBM)
Standard: JEDEC Standard JESD22-A114

ESD Rating: Class IV
Value: Passes ≥ 1000 V min.
Test: Charged Device Model (CDM)
Standard:

MSL Rating

The part is rated Moisture Sensitivity Level 3 at 260°C per JEDEC standard IPC/JEDEC J-STD-020.

Solderability

Compatible with the latest version of J-STD-020, Lead free solder, 260°

This part is compliant with EU 2002/95/EC RoHS directive (Restrictions on the Use of Certain Hazardous Substances in Electrical and Electronic Equipment).

This product also has the following attributes:

- Lead Free

Contact Information

For the latest specifications, additional product information, worldwide sales and distribution locations, and information about TriQuint:

Web: www.triquint.com
Email: info-sales@tqs.com

Tel: +1.707.526.4498
Fax: +1.707.526.1485

For technical questions and application information:

Email: sicapplication.engineering@tqs.com

Important Notice

The information contained herein is believed to be reliable. TriQuint makes no warranties regarding the information contained herein. TriQuint assumes no responsibility or liability whatsoever for any of the information contained herein. TriQuint assumes no responsibility or liability whatsoever for the use of the information contained herein. The information contained herein is provided "AS IS, WHERE IS" and with all faults, and the entire risk associated with such information is entirely with the user. All information contained herein is subject to change without notice. Customers should obtain and verify the latest relevant information before placing orders for TriQuint products. The information contained herein or any use of such information does not grant, explicitly or implicitly, to any party any patent rights, licenses, or any other intellectual property rights, whether with regard to such information itself or anything described by such information.

TriQuint products are not warranted or authorized for use as critical components in medical, life-saving, or life-sustaining applications, or other applications where a failure would reasonably be expected to cause severe personal injury or death.