

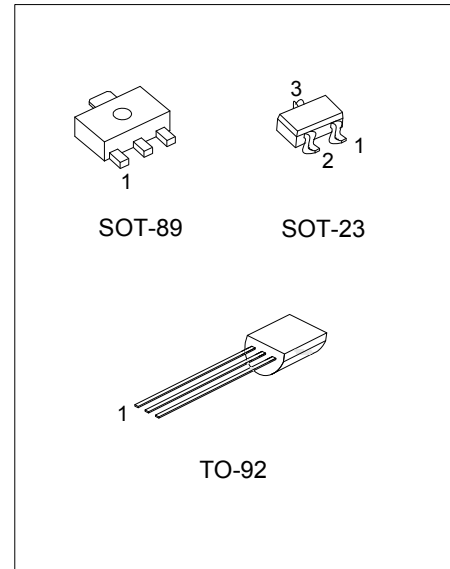

**MCR100**

**SCR**

SENSITIVE GATE SILICON  
CONTROLLED RECTIFIERS  
REVERSE BLOCKING  
THYRISTORS



Lead-free: MCR100L  
Halogen-free: MCR100G

■ DESCRIPTION

PNPN devices designed for high volume, line-powered consumer applications such as relay and lamp drivers, small motor controls, gate drivers for larger thyristors, and sensing and detection circuits.

■ FEATURES

- \* Sensitive gate allows triggering by micro controllers and other logic circuits
- \* Blocking voltage to 600V
- \* On-state current rating of 0.8A RMS at 80°C
- \* High surge current capability – 10A
- \* Minimum and maximum values of  $I_{GT}$ ,  $V_{GT}$  and  $I_H$  specified for ease of design
- \* Immunity to  $dV/dt$  – 20V/ $\mu$ sec minimum at 110°C
- \* Glass-passivated surface for reliability and uniformity

■ ORDERING INFORMATION

Ordering Number			Package	Pin assignment			Packing
Normal	Lead Free Plating	Halogen Free		1	2	3	
MCR100-4-x-AB3-R	MCR100L-4-x-AB3-R	MCR100G-4-x-AB3-R	SOT-89	G	A	K	Tape Reel
MCR100-4-x-AE3-R	MCR100L-4-x-AE3-R	MCR100G-4-x-AE3-R	SOT-23	G	K	A	Tape Reel
MCR100-4-x-T92-B	MCR100L-4-x-T92-B	MCR100G-4-x-T92-B	TO-92	K	G	A	Tape Box
MCR100-4-x-T92-K	MCR100L-4-x-T92-K	MCR100G-4-x-T92-K	TO-92	K	G	A	Bulk
MCR100-6-x-AB3-R	MCR100L-6-x-AB3-R	MCR100G-6-x-AB3-R	SOT-89	G	A	K	Tape Reel
MCR100-6-x-AE3-R	MCR100L-6-x-AE3-R	MCR100G-6-x-AE3-R	SOT-23	G	K	A	Tape Reel
MCR100-6-x-T92-B	MCR100L-6-x-T92-B	MCR100G-6-x-T92-B	TO-92	K	G	A	Tape Box
MCR100-6-x-T92-K	MCR100L-6-x-T92-K	MCR100G-6-x-T92-K	TO-92	K	G	A	Bulk
MCR100-8-x-AB3-R	MCR100L-8-x-AB3-R	MCR100G-8-x-AB3-R	SOT-89	G	A	K	Tape Reel
MCR100-8-x-AE3-R	MCR100L-8-x-AE3-R	MCR100G-8-x-AE3-R	SOT-23	G	K	A	Tape Reel
MCR100-8-x-T92-B	MCR100L-8-x-T92-B	MCR100G-8-x-T92-B	TO-92	K	G	A	Tape Box
MCR100-8-x-T92-K	MCR100L-8-x-T92-K	MCR100G-8-x-T92-K	TO-92	K	G	A	Bulk

Note: Pin assignment: G: Gate K: Cathode A: Anode

<p>MCR100L-4-x-AB3-R</p>	<p>(1) B: Tape Box, K: Bulk, R: Tape Reel</p> <p>(2) AB3: SOT-89, AE3: SOT-23, T92: TO-92</p> <p>(3) x: Refer to CLASSIFICATION OF <math>I_{GT}</math></p> <p>(4) G: Halogen Free, L: Lead Free, Blank: Pb/Sn</p>
--------------------------	-------------------------------------------------------------------------------------------------------------------------------------------------------------------------------------------------------------------

■ MARKING FOR SOT-23

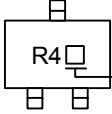
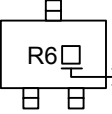
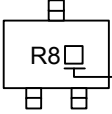
MCR100-4	MCR100-6	MCR100-8
 <p>L: Lead Free G: Halogen Free</p>	 <p>L: Lead Free G: Halogen Free</p>	 <p>L: Lead Free G: Halogen Free</p>



## MCR100

SCR

### ■ ABSOLUTE MAXIMUM RATINGS

PARAMETER		SYMBOL	RATINGS	UNIT
Peak Repetitive Off-State Voltage(Note 1) ( $T_J=-40 \sim 110^\circ\text{C}$ , Sine Wave, 50 ~ 60Hz; Gate Open)	MCR100-4	$V_{DRM}, V_{RRM}$	200	V
	MCR100-6		400	V
	MCR100-8		600	V
On-State RMS Current ( $T_C=80^\circ\text{C}$ ) 180°C Condition Angles		$I_{T(RMS)}$	0.8	A
Peak Non-Repetitive Surge Current (1/2 cycle, Sine Wave, 60Hz, $T_J=25^\circ\text{C}$ )		$I_{TSM}$	10	A
Circuit Fusing Considerations ( $t=8.3$ ms)		$I^2t$	0.415	$\text{A}^2\text{s}$
Forward Peak Gate Power ( $T_A=25^\circ\text{C}$ , Pulse Width $\leq 1.0\mu\text{s}$ )		$P_{GM}$	0.1	W
Forward Average Gate Power ( $T_A=25^\circ\text{C}$ , $t=8.3\text{ms}$ )		$P_{G(AV)}$	0.1	W
Peak Gate Current – Forward ( $T_A=25^\circ\text{C}$ , Pulse Width $\leq 1.0\mu\text{s}$ )		$I_{GM}$	1	A
Peak Gate Voltage – Reverse ( $T_A=25^\circ\text{C}$ , Pulse Width $\leq 1.0\mu\text{s}$ )		$V_{GRM}$	5	V
Operating Junction Temperature Range (Rated $V_{RRM}$ and $V_{DRM}$ )		$T_J$	-40 ~ +110	$^\circ\text{C}$
Storage Temperature Range		$T_{STG}$	-40 ~ +150	$^\circ\text{C}$

Note: Absolute maximum ratings are those values beyond which the device could be permanently damaged.

Absolute maximum ratings are stress ratings only and functional device operation is not implied.

### ■ THERMAL DATA

PARAMETER		SYMBOL	MAX	UNIT
Junction to Ambient	TO-92	$\theta_{JA}$	200	$^\circ\text{C/W}$
	SOT-23/SOT-89		400	$^\circ\text{C/W}$

### ■ ELECTRICAL CHARACTERISTICS ( $T_J=25^\circ\text{C}$ , unless otherwise stated)

PARAMETER		SYMBOL	TEST CONDITIONS	MIN	TYP	MAX	UNIT
<b>OFF CHARACTERISTICS</b>							
Peak Forward or Reverse Blocking Current	$T_C=25^\circ\text{C}$	$I_{DRM}, I_{RRM}$	$V_D=\text{Rated } V_{DRM} \text{ and } V_{RRM};$ $R_{GK}=1\text{k}\Omega$			10	$\mu\text{A}$
	$T_C=125^\circ\text{C}$					100	$\mu\text{A}$
<b>ON CHARACTERISTICS</b>							
Peak Forward On-State Voltage (Note 2)		$V_{TM}$	$I_{TM}=1\text{A Peak @ } T_A=25^\circ\text{C}$			1.7	V
Gate Trigger Current (Continuous DC)(Note3)		$I_{GT}$	$V_{AK}=7\text{Vdc}, R_L=100\Omega, T_C=25^\circ\text{C}$		40	200	$\mu\text{A}$
Holding Current (Note 4)	$T_C=25^\circ\text{C}$	$I_H$	$V_{AK}=7\text{Vdc}$ , initiating current=20mA		0.5	5	mA
	$T_C=-40^\circ\text{C}$					10	mA
Latch Current	$T_C=25^\circ\text{C}$	$I_L$	$V_{AK}=7\text{V}$ , $I_g=200\mu\text{A}$		0.6	10	mA
	$T_C=-40^\circ\text{C}$					15	mA
Gate Trigger Voltage (continuous dc) (Note 3)	$T_C=25^\circ\text{C}$	$V_{GT}$	$V_{AK}=7\text{Vdc}, R_L=100\Omega$		0.62	0.8	V
	$T_C=-40^\circ\text{C}$					1.2	V
<b>DYNAMIC CHARACTERISTICS</b>							
Critical Rate of Rise of Off-State Voltage		$d_V/dt$	$V_D=\text{Rated } V_{DRM}$ , Exponential Waveform, $R_{GK}=1000\Omega$ , $T_J=110^\circ\text{C}$	20	35		V/ $\mu\text{s}$
Critical Rate of Rise of On-State Current		$di/dt$	$I_{PK}=20\text{A}$ ; $P_w=10\mu\text{sec}$ ; $di/dt=1\text{A}/\mu\text{sec}$ , $I_{gt}=20\text{mA}$			50	A/ $\mu\text{s}$

Notes: 1.  $V_{DRM}$  and  $V_{RRM}$  for all types can be applied on a continuous basis. Ratings apply for zero or negative gate voltage; however, positive gate voltage shall not be applied concurrent with negative potential on the anode. Blocking voltages shall not be tested with a constant current source such that the voltage ratings of the devices are exceeded.

2. Indicates Pulse Test Width  $\leq 1.0\text{ms}$ , duty cycle  $\leq 1\%$

3.  $R_{GK}=1000\Omega$  included in measurement.

4. Does not include  $R_{GK}$  in measurement



**MCR100**

**SCR**

■ VOLTAGE CURRENT CHARACTERISTIC OF SCR

PARAMETER	SYMBOL
Peak Repetitive Off Stat Forward Voltage	$V_{DRM}$
Peak Forward Blocking Current	$I_{DRM}$
Peak Repetitive Off State Reverse Voltage	$V_{RRM}$
Peak Reverse Blocking Current	$I_{RRM}$
Peak On State Voltage	$V_{TM}$
Holding Current	$I_H$

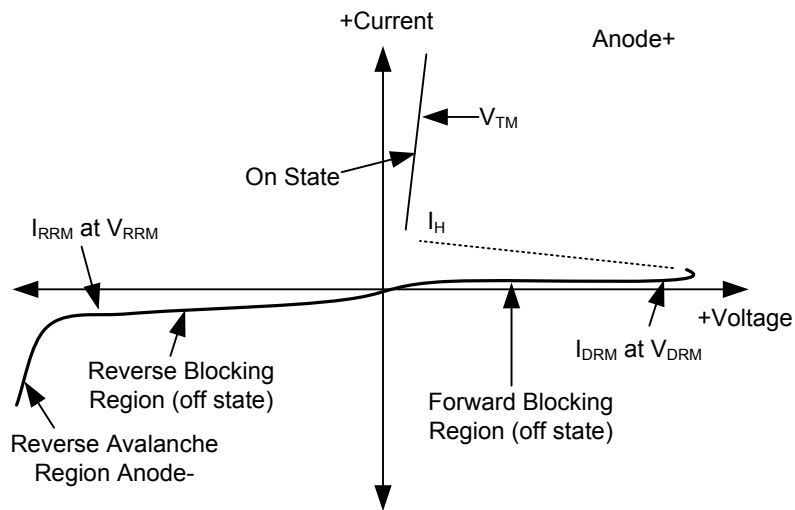

■ CLASSIFICATION OF  $I_{GT}$

RANK	B	C	AA	AB	AC	AD
RANGE	48~105 $\mu$ A	95~200 $\mu$ A	8~16 $\mu$ A	14~21 $\mu$ A	19~25 $\mu$ A	23~52 $\mu$ A

## ■ TYPICAL CHARACTERISTICS

Typical Gate Trigger Current vs. Junction Temperature

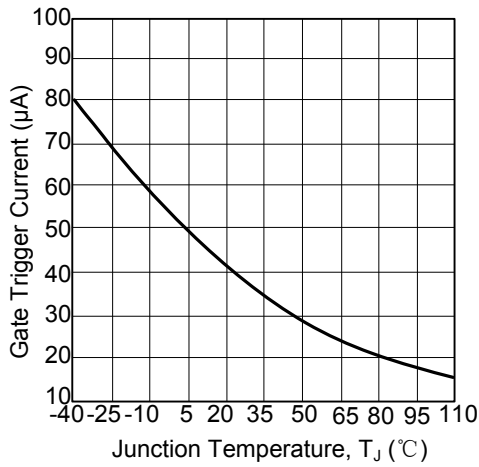

Typical Gate Trigger Voltage vs. Junction Temperature

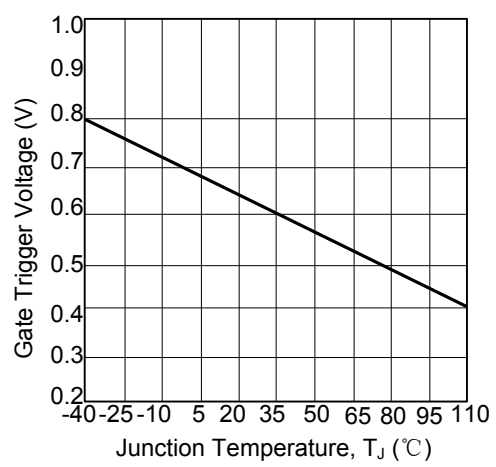

Typical Holding Current vs. Junction Temperature

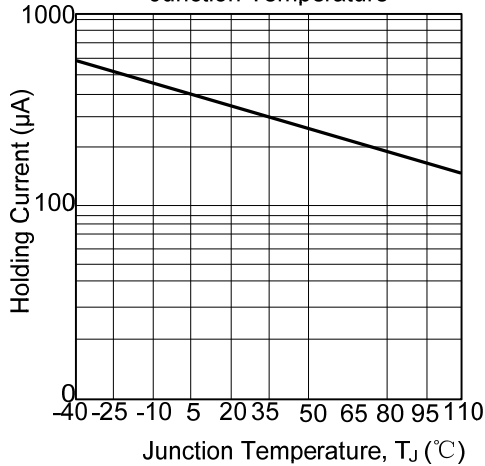

Typical Latching Current vs. Junction Temperature

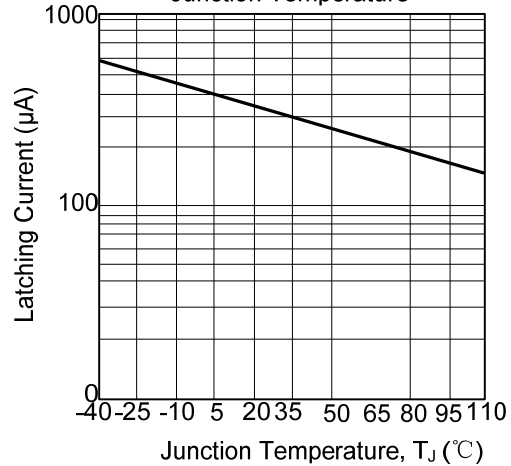

Typical RMS Current Derating

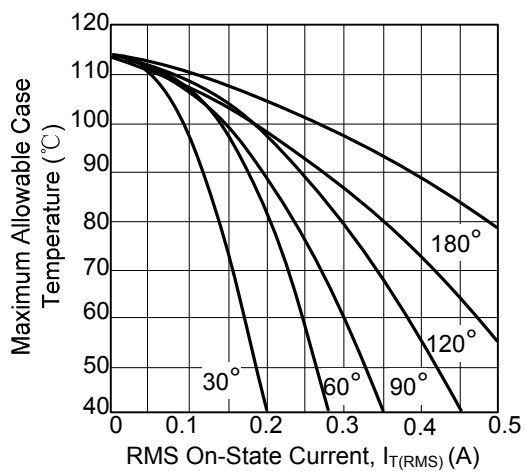

Typical On-State Characteristics

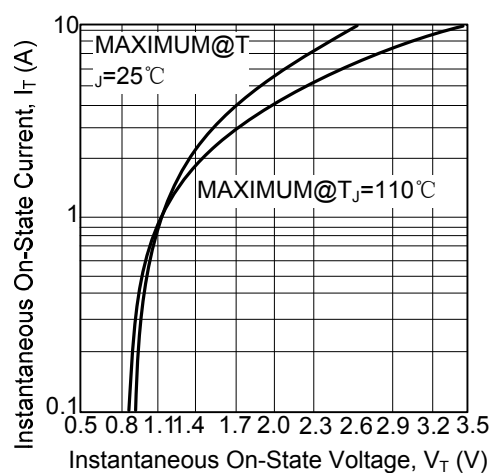

UTC assumes no responsibility for equipment failures that result from using products at values that exceed, even momentarily, rated values (such as maximum ratings, operating condition ranges, or other parameters) listed in products specifications of any and all UTC products described or contained herein. UTC products are not designed for use in life support appliances, devices or systems where malfunction of these products can be reasonably expected to result in personal injury. Reproduction in whole or in part is prohibited without the prior written consent of the copyright owner. The information presented in this document does not form part of any quotation or contract, is believed to be accurate and reliable and may be changed without notice.