

Description

The open LED protector provides a switching electronic shunt path when an LED in an LED array fails as an open circuit. This ensures that the entire array of LEDs will continue to function even if a single LED in the array does not. This provides higher reliable lighting functions in applications such as headlights, aircrafts, aircraft runway lighting, Roadside warning lights, etc. This device is compatible with one, two and three watt LEDs that have a nominal 3V forward characteristic.



SMA

Electrical Characteristics (Tamb=25°C)

Part Number	V _{DRM} breakdown	I _{DRM}	V _{BR} breakdown	I _S	V _T	I _T	I _H
	Min.	Max.	Max.	Max.	Max.	Max.	Min.
	V	uA	V	mA	V	A	mA
PLED06CA	6	10	15	600	1.5	1	5

General Notes:

- All measurements are made at an ambient temperature of 25°C. I_{pp} applies to -40°C through +85°C temperature range.
- Special voltage (V_{BO} and V_{DRM}) and holding current (I_H) requirements are available upon request.

Electrical Parameters (Tamb=25°C)

Symbol	Parameter	Symbol	Parameter
V _{DRM}	Stand-off voltage, is measured at I _{DRM}	I _H	Holding current
I _{DRM}	Leakage current, is measured at V _{DRM}	I _T	ON-state current
V _{BR}	Breakover voltage, is measured at 100V/μs	V _T	On-state voltage
I _S	Breakover current		

Thermal Considerations

Package DO214AC	Symbol	Parameter	Value	Unit
	T_J	Operating Junction Temperature	-40 to +150	$^{\circ}\text{C}$
	T_S	Storage Temperature Range	-60 to +150	$^{\circ}\text{C}$
	$R_{\theta JA}$	Junction to Ambient on printed circuit	90	$^{\circ}\text{C}/\text{W}$

V-I Characteristics

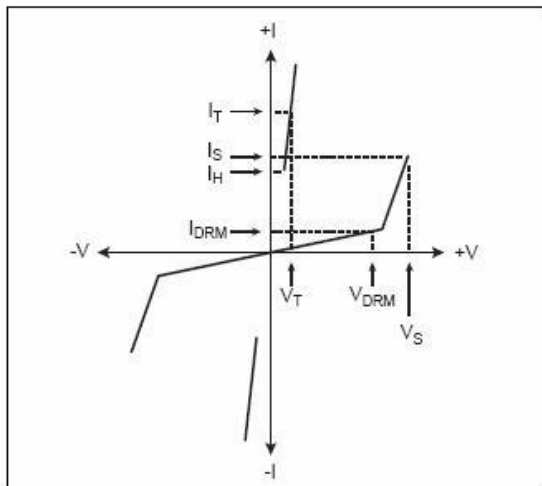

V_{BR} vs. Junction Temperature

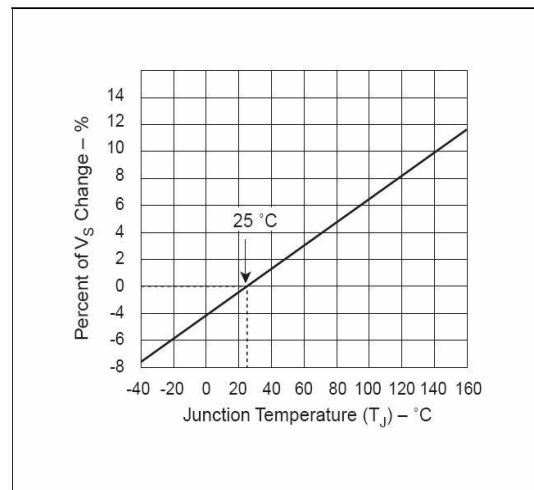

Normalized DC Holding Current vs. Case Temperature

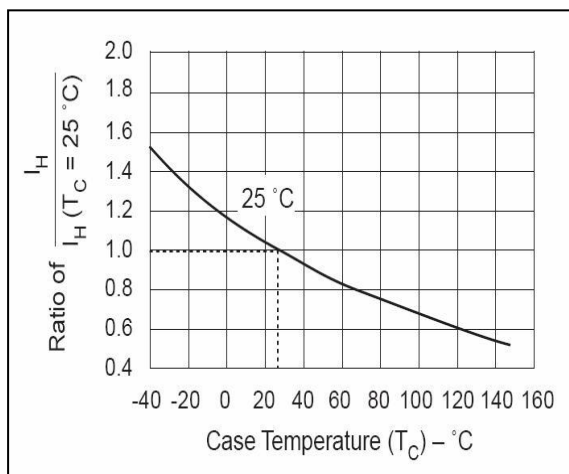

LED Interference Test Circuit

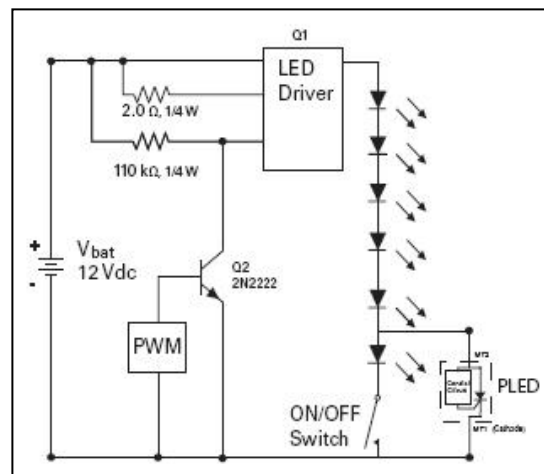

Product Dimensions

Dimension	Inches		Millimeters	
	MIN	MAX	MIN	MAX
A	0.098	0.114	2.50	2.90
B	0.188	0.208	4.80	5.28
C	0.055	0.062	1.40	1.60
D	0.157	0.181	4.00	4.60
E	0.030	0.060	0.76	1.52
F	0.078	0.096	2.00	2.44
H	0.080	0.104	2.051	2.643

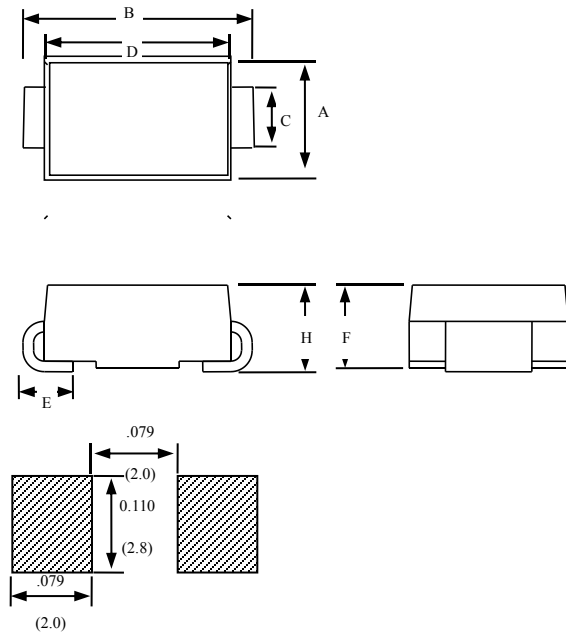

Summary of Packing Options

Package Type	Description	Packing Quantity	Industry Standard
D0214AC 	Embossed Carrier Reel Pack	5000PCS	