

## Schottky Rectifier, 2 x 20 A

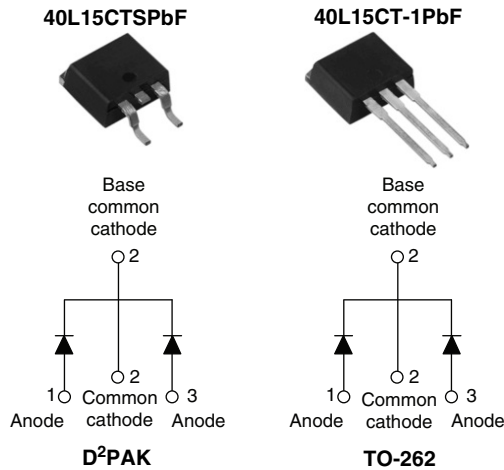

### FEATURES

- 125 °C T<sub>J</sub> operation (V<sub>R</sub> < 5 V)
- Center tap module
- Optimized for OR-ing applications
- Ultra low forward voltage drop
- High frequency operation
- High purity, high temperature epoxy encapsulation for enhanced mechanical strength and moisture resistance
- Guard ring for enhanced ruggedness and long term reliability
- Lead (Pb)-free ("PbF" suffix)
- Designed and qualified for Q101 level



Available  
**RoHS\***  
COMPLIANT

### DESCRIPTION

The center tap Schottky rectifier module has been optimized for ultra low forward voltage drop specifically for the OR-ing of parallel power supplies. The proprietary barrier technology allows for reliable operation up to 125 °C junction temperature. Typical applications are in parallel switching power supplies, converters, reverse battery protection, and redundant power subsystems.

### PRODUCT SUMMARY

I <sub>F(AV)</sub>	2 x 20 A
V <sub>R</sub>	15 V
I <sub>RM</sub>	600 mA at 100 °C

### MAJOR RATINGS AND CHARACTERISTICS

SYMBOL	CHARACTERISTICS	VALUES	UNITS
I <sub>F(AV)</sub>	Rectangular waveform	40	A
V <sub>RRM</sub>		15	V
I <sub>FSM</sub>	t <sub>p</sub> = 5 μs sine	700	A
V <sub>F</sub>	19 Apk, T <sub>J</sub> = 125 °C (per leg, typical)	0.25	V
T <sub>J</sub>		- 55 to 125	°C

### VOLTAGE RATINGS

PARAMETER	SYMBOL	TEST CONDITIONS	40L15CTSPbF 40L15CT-1PbF	UNITS
Maximum DC reverse voltage	V <sub>R</sub>	T <sub>J</sub> = 100 °C	15	V
Maximum working peak reverse voltage	V <sub>RWM</sub>			

### ABSOLUTE MAXIMUM RATINGS

PARAMETER	SYMBOL	TEST CONDITIONS	VALUES	UNITS
Maximum average forward current per leg per device	I <sub>F(AV)</sub>	50 % duty cycle at T <sub>C</sub> = 85 °C, rectangular waveform	20	A
			40	
Maximum peak one cycle non-repetitive surge current per leg	I <sub>FSM</sub>	5 μs sine or 3 μs rect. pulse	700	A
		10 ms sine or 6 ms rect. pulse	330	
Non-repetitive avalanche energy per leg	E <sub>AS</sub>	T <sub>J</sub> = 25 °C, I <sub>AS</sub> = 2 A, L = 6 mH	10	mJ
Repetitive avalanche current per leg	I <sub>AR</sub>	Current decaying linearly to zero in 1 μs Frequency limited by T <sub>J</sub> maximum V <sub>A</sub> = 1.5 x V <sub>R</sub> typical	2	A

\* Pb containing terminations are not RoHS compliant, exemptions may apply

# 40L15CTSPbF/40L15CT-1PbF



Vishay High Power Products Schottky Rectifier, 2 x 20 A

ELECTRICAL SPECIFICATIONS						
PARAMETER	SYMBOL	TEST CONDITIONS		TYP.	MAX.	UNITS
Maximum forward voltage drop per leg See fig. 1	$V_{FM}^{(1)}$	19 A	$T_J = 25\text{ }^\circ\text{C}$	-	0.41	V
		40 A		-	0.52	
		19 A	$T_J = 125\text{ }^\circ\text{C}$	0.25	0.33	
		40 A		0.37	0.50	
Reverse leakage current per leg See fig. 2	$I_{RM}^{(1)}$	$T_J = 25\text{ }^\circ\text{C}$	$V_R = \text{Rated } V_R$	-	10	mA
		$T_J = 100\text{ }^\circ\text{C}$		-	600	
Threshold voltage	$V_{F(TO)}$	$T_J = T_J \text{ maximum}$		0.182		V
Forward slope resistance	$r_t$	$T_J = T_J \text{ maximum}$		7.6		m $\Omega$
Maximum junction capacitance per leg	$C_T$	$V_R = 5 V_{DC}$ (test signal range 100 kHz to 1 MHz) 25 $^\circ\text{C}$		-	2000	pF
Typical series inductance per leg	$L_S$	Measured lead to lead 5 mm from package body		8	-	nH
Maximum voltage rate of change	dV/dt	Rated $V_R$		10 000		V/ $\mu\text{s}$

**Note**

(1) Pulse width < 300  $\mu\text{s}$ , duty cycle < 2 %

THERMAL - MECHANICAL SPECIFICATIONS					
PARAMETER	SYMBOL	TEST CONDITIONS	VALUES	UNITS	
Maximum junction temperature range	$T_J$		- 55 to 125	°C	
Maximum storage temperature range	$T_{Stg}$		- 55 to 150		
Maximum thermal resistance, junction to case per leg	$R_{thJC}$	DC operation See fig. 4	1.5	°C/W	
Typical thermal resistance, case to heatsink	$R_{thCS}$	Mounting surface, smooth and greased	0.50		
Maximum thermal resistance, junction to ambient	$R_{thJA}$	DC operation	40		
Approximate weight			2	g	
			0.07	oz.	
Mounting torque	minimum	Non-lubricated threads	6 (5)	kgf · cm (lbf · in)	
	maximum		12 (10)		
Marking device		Case style D <sup>2</sup> PAK	40L15CTS		
		Case style TO-262	40L15CT-1		

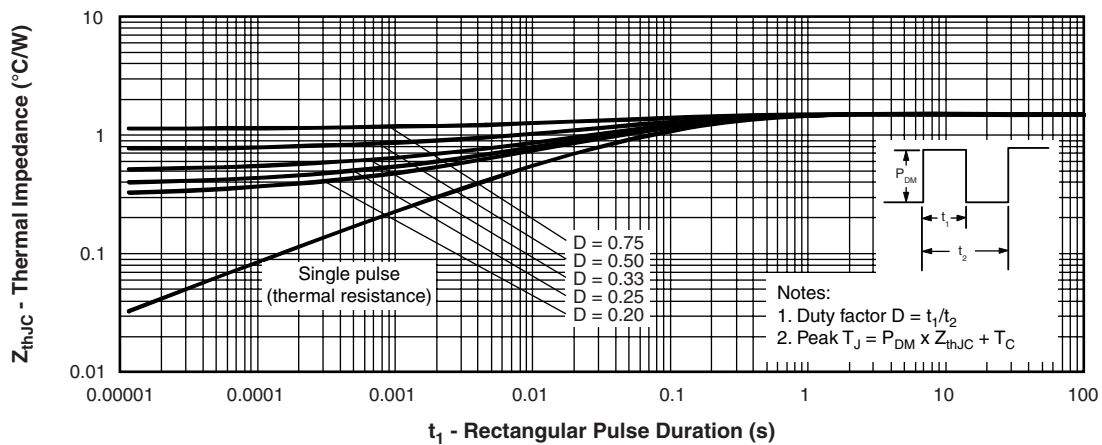
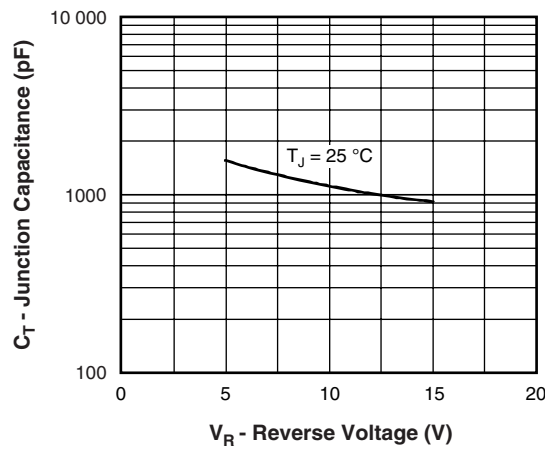
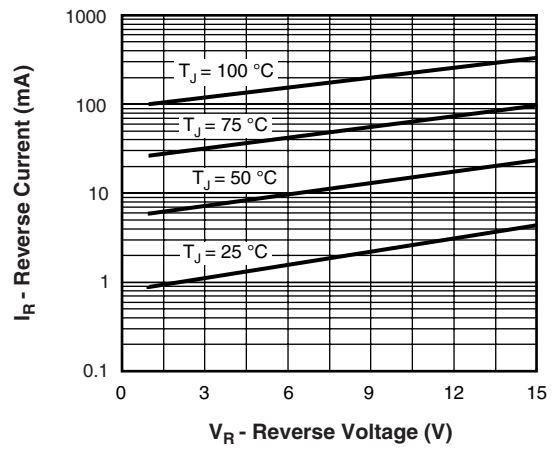
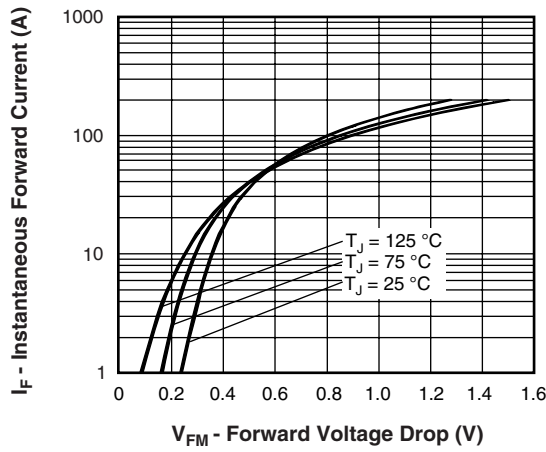

# 40L15CTSPbF/40L15CT-1PbF

Vishay High Power Products Schottky Rectifier, 2 x 20 A

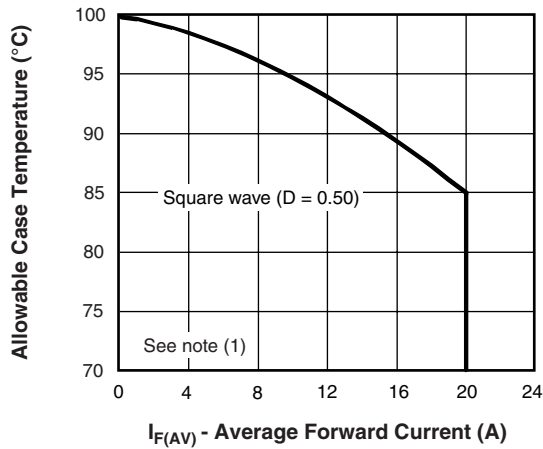

Fig. 5 - Maximum Allowable Case Temperature vs. Average Forward Current

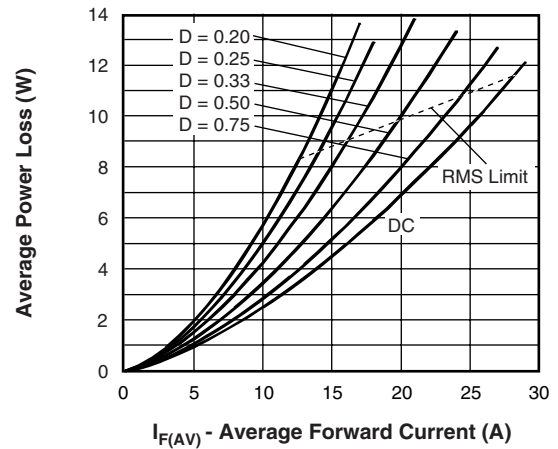

Fig. 6 - Forward Power Loss Characteristics

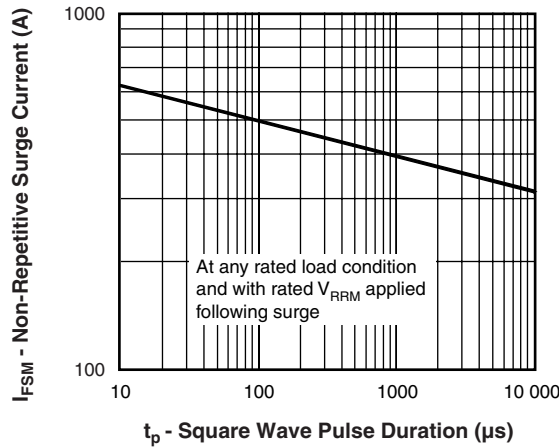

Fig. 7 - Maximum Non-Repetitive Surge Current

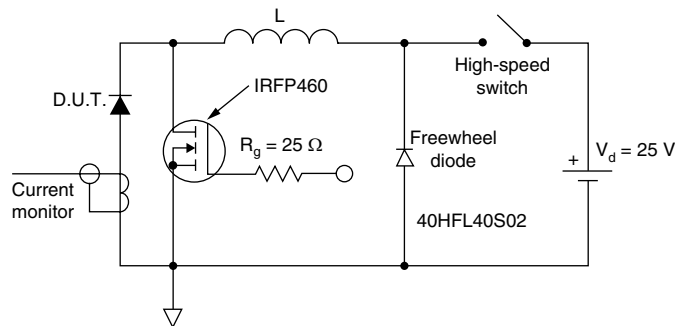

Fig. 8 Unclamped Inductive Test Circuit

**Note**

- (1) Formula used:  $T_C = T_J - (P_d + P_{d_{REV}}) \times R_{thJC}$ ;
- $P_d$  = Forward power loss =  $I_{F(AV)} \times V_{FM}$  at  $(I_{F(AV)}/D)$  (see fig. 6);
- $P_{d_{REV}}$  = Inverse power loss =  $V_{R1} \times I_R (1 - D)$ ;  $I_R$  at  $V_{R1} = 80\%$  rated  $V_R$



# 40L15CTSPbF/40L15CT-1PbF

Schottky Rectifier, 2 x 20 A Vishay High Power Products

## ORDERING INFORMATION TABLE

Device code	<b>40</b>	<b>L</b>	<b>15</b>	<b>C</b>	<b>T</b>	<b>S</b>	<b>TRL</b>	<b>PbF</b>
	①	②	③	④	⑤	⑥	⑦	⑧

- 1** - Current rating (40 A)
- 2** - L = Schottky "L" series
- 3** - Voltage rating (15 V)
- 4** - C = Common cathode
- 5** - T = TO-220
- 6** -
  - S = D<sup>2</sup>PAK
  - -1 = TO-262
- 7** -
  - None = Tube (50 pieces)
  - TRL = Tape and reel (left oriented - for D<sup>2</sup>PAK only)
  - TRR = Tape and reel (right oriented - for D<sup>2</sup>PAK only)
- 8** -
  - None = Standard production
  - PbF = Lead (Pb)-free

LINKS TO RELATED DOCUMENTS	
Dimensions	<a href="http://www.vishay.com/doc?95014">http://www.vishay.com/doc?95014</a>
Part marking information	<a href="http://www.vishay.com/doc?95008">http://www.vishay.com/doc?95008</a>
Packaging information	<a href="http://www.vishay.com/doc?95032">http://www.vishay.com/doc?95032</a>



## Disclaimer

All product specifications and data are subject to change without notice.

Vishay Intertechnology, Inc., its affiliates, agents, and employees, and all persons acting on its or their behalf (collectively, "Vishay"), disclaim any and all liability for any errors, inaccuracies or incompleteness contained herein or in any other disclosure relating to any product.

Vishay disclaims any and all liability arising out of the use or application of any product described herein or of any information provided herein to the maximum extent permitted by law. The product specifications do not expand or otherwise modify Vishay's terms and conditions of purchase, including but not limited to the warranty expressed therein, which apply to these products.

No license, express or implied, by estoppel or otherwise, to any intellectual property rights is granted by this document or by any conduct of Vishay.

The products shown herein are not designed for use in medical, life-saving, or life-sustaining applications unless otherwise expressly indicated. Customers using or selling Vishay products not expressly indicated for use in such applications do so entirely at their own risk and agree to fully indemnify Vishay for any damages arising or resulting from such use or sale. Please contact authorized Vishay personnel to obtain written terms and conditions regarding products designed for such applications.

Product names and markings noted herein may be trademarks of their respective owners.