

PLEASE CHECK WWW.MOLEX.COM FOR LATEST PART INFORMATION

Part Number: [0026034020](#)
Status: **Active**
Overview: [kk](#)
Description: 3.96mm (.156") Pitch KK® Crimp Terminal Housing - Use With Trifurcon® Terminals, Friction Ramp, 2 Circuits

Documents:

[3D Model](#) [Product Specification PS-40-02 \(PDF\)](#)
[Drawing \(PDF\)](#) [RoHS Certificate of Compliance \(PDF\)](#)

Agency Certification

CSA LR19980
 UL E29179

General

Product Family Crimp Housings
 Series [6442](#)
 Overview [kk](#)
 Product Name KK®

Physical

Circuits (maximum) 2
 Color - Resin Natural
 Flammability 94V-2
 Gender Female
 Glow-Wire Compliant No
 Lock to Mating Part Yes
 Material - Resin Nylon
 Number of Rows 1
 Packaging Type Bag
 Panel Mount No
 Pitch - Mating Interface (in) 0.156 In
 Pitch - Mating Interface (mm) 3.96 mm
 Stackable No
 Temperature Range - Operating 0°C to +75°C

Material Info

Old Part Number 6442-R02-Z

Reference - Drawing Numbers

Product Specification PS-40-02
 Sales Drawing SD-6442

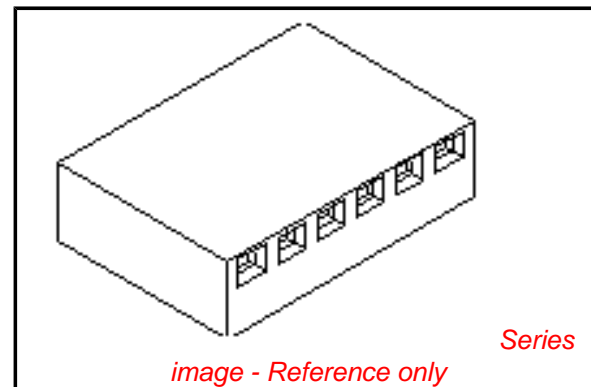

EU RoHS

**ELV and RoHS
 Compliant**
**REACH SVHC
 Contains SVHC: No**
**Halogen-Free
 Status
 Not Reviewed**

China RoHS



**Need more information on product
 environmental compliance?**

Email productcompliance@molex.com
 For a multiple part number RoHS Certificate of Compliance, [click here](#)

Please visit the [Contact Us](#) section for any non-product compliance questions.

Search Parts in this Series

[6442Series](#)

Mates With

Molex 3.96mm (.156") pitch KK® headers

Use With

[6838](#) and [7258](#) KK® Trifurcon crimp terminals

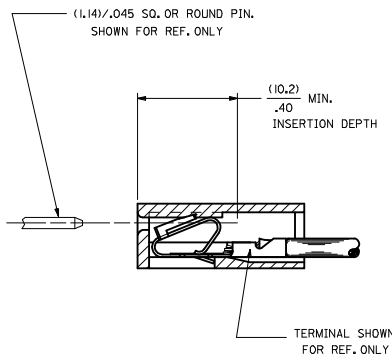
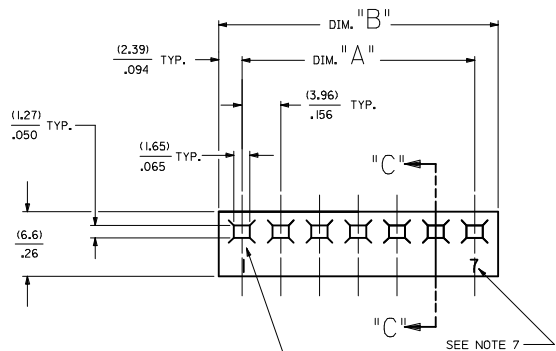

SECTION "C-C"

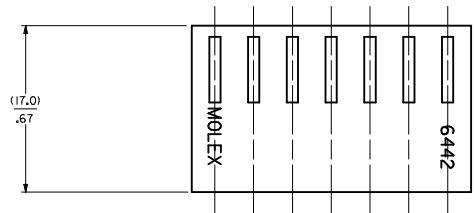

NO. OF CKT'S.	DIM. A	DIM. B
1	-----	(4.78+.18)
2	(3.96+.13)	(8.74+.18)
3	.156+.005	.344+.007
4	(7.92+.13)	(12.70+.18)
5	.312+.005	.500+.007
6	(11.89+.13)	(16.66+.18)
7	.468+.005	.656+.007
8	(15.85+.13)	(20.62+.18)
9	.624+.005	.812+.007
10	(19.81+.13)	(24.59+.18)
11	.780+.005	.968+.007
12	(23.77+.13)	(28.55+.18)
13	.936+.005	1.124+.007
14	(27.74+.25)	(32.51+.30)
15	1.092+.010	1.280+.012
16	(31.70+.25)	(36.47+.30)
17	1.248+.010	1.436+.012
18	(35.66+.25)	(40.44+.30)
19	1.404+.010	1.592+.012
20	(39.62+.25)	(44.40+.30)
21	1.560+.010	1.748+.012
22	(43.59+.25)	(48.36+.30)
23	1.716+.010	1.904+.012
24	(47.55+.30)	(52.32+.36)
	1.872+.012	2.060+.014
	(51.51+.36)	(56.29+.41)
	2.028+.014	2.216+.016
	(55.47+.36)	(60.25+.41)
	2.184+.014	2.372+.016
	(59.44+.36)	(64.21+.41)
	2.340+.014	2.528+.016
	(63.40+.36)	(68.17+.41)
	2.496+.014	2.684+.016
	(67.36+.36)	(72.14+.41)
	2.652+.014	2.840+.016
	(71.32+.36)	(76.10+.41)
	2.808+.014	2.996+.016
	(75.29+.46)	(80.06+.51)
	2.964+.018	3.152+.020
	(79.25+.46)	(84.02+.51)
	3.120+.018	3.308+.020
	(83.21+.46)	(87.99+.51)
	3.276+.018	3.464+.020
	(87.17+.46)	(91.95+.51)
	3.432+.018	3.620+.020
	(91.14+.46)	(95.91+.51)
	3.588+.018	3.776+.020

- NOTES:
1. MATERIAL A: NYLON 6/6 UL94V-2. COLOR: NATURAL
 2. FINISH: N/A
 3. THIS PART COMPLIES WITH PRODUCT SPECIFICATION PS-40-02.
 4. SEE SHEET 2 FOR OPTIONS.
 5. HOUSING SHOWN ABOVE IS STANDARD HOUSING WITH NO OPTIONS.
 6. THIS HOUSING FOR USE WITH TERMINAL NO.,
6438-N, (18-22 GA) WITH (2.79)/.110 MAX. INSULATION DIA.
6838-N, (18-24 GA) WITH (2.79)/.110 MAX. INSULATION DIA.
7258-N, (22-26 GA) WITH (1.65)/.065 MAX. INSULATION DIA.
 7. CIRCUIT SIZE MOLDED ON 4 THRU 24 CIRCUIT HOUSINGS ONLY.
 8. THIS PART CONFORMS TO CLASS B REQUIREMENTS OF COSMETIC SPECIFICATION PS-45499-002.

HOUSING OPTIONS

CODE	HOOKS	SIDE HOOKS	RAMP
BLANK	NONE	NONE	NONE
A	NONE	YES	NONE
R	NONE	NONE	FRICITION
B	NONE	NONE	TYPE B
C	NONE	NONE	TYPE C

6442- * N - * - * - *

VOLTAGE RATING OPTION
BLANK=NONE
V= '250 VAC' ON HOUSING

MAT'L OPTION
BLANK= MATERIAL A (SEE NOTE 1)

MOLDED VOID CODE
Z=NO VOIDS
A=CKT. 1 VOID,
B=CKT. 2 VOID, ETC.
5I=1ST MULTIPLE VOID,
52=2ND MULTIPLE VOID, ETC.

NO. OF CKT'S.

REMOVE D OPTION EC NO: UCP2009-3148 DRAWN/KIPER 2009/07/13 CHKD/SSOUSEK 2009/07/13 APPR/FSMTH 2009/08/05	QUALITY SYMBOLS	GENERAL TOLERANCES (UNLESS SPECIFIED)	DIMENSION STYLE	SCALE	DESIGN UNITS	THIRD ANGLE PROJECTION
	4 PLACES ± --- ± --- 3 PLACES ± --- ± .010 2 PLACES ± 0.25 ± .014 1 PLACE ± 0.36 ± --- ANGULAR ±1/2°	mm INCH	MM/IN	DATE	INCH	INCH
			DRAWN BY POLGAR 1986/12/03			TITLE
			CHECKED BY PATEL 1986/12/03			KK (3.96)/.156 TRIFURCON CRIMP TERMINAL HOUSING 6442 SERIES
			APPROVED BY ENZ 1986/12/03			MOLEX INCORPORATED
			MATERIAL NO. SEE CHART			DOCUMENT NO. SD-6442
			DRAFT WHERE APPLICABLE MUST REMAIN WITHIN DIMENSIONS			SHEET NO. 1 OF 4
			SIZE D THIS DRAWING CONTAINS INFORMATION THAT IS PROPRIETARY TO MOLEX INCORPORATED AND SHOULD NOT BE USED WITHOUT WRITTEN PERMISSION			

20 19 18 17 16 15 14 13 12 11 10 9 8 7 6 5 4 3 2 1

CONTINUOUS RAMP ON HOUSINGS UP TO 8 CIRCUITS, AND ON 9 THRU 24 CIRCUITS, RAMP ARE 4 CIRCUITS LONG, LOCATED AT BOTH ENDS.

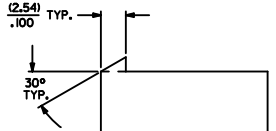
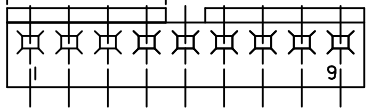

STD. RAMP OPTION CODE "R"

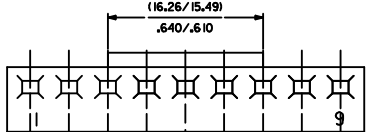

SELECTIVE RAMP OPTION CODE "C"

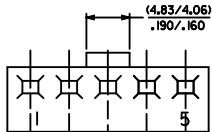

SELECTIVE RAMP OPTION CODE "B"

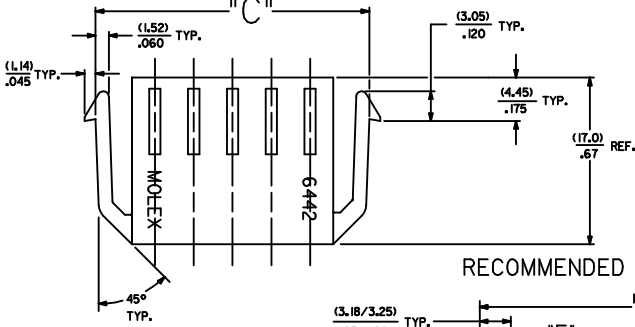
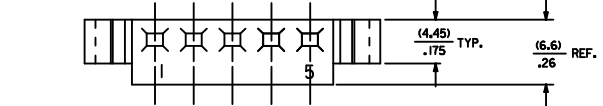

SIDE HOOKS OPTION CODE "A"

RECOMMENDED (2.03)/.080 THICK PANEL OPENING.

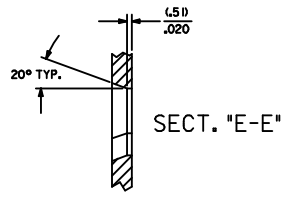
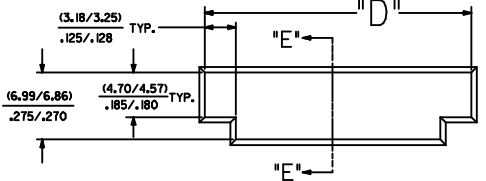

SECT. "E-E"

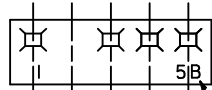

SINGLE VOID

SINGLE CKT. VOID CODE

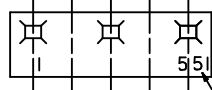

MULTIPLE VOIDS

MULTIPLE CKT. VOID CODE

MOLDED VOIDS
SEE LEGEND ON SHT. 1
SEE CHART FOR VOID CKT. LOCATIONS

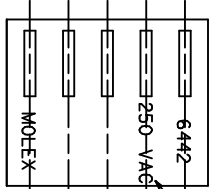

SEE LEGEND ON SHT. 1

OPT. VOLTAGE RATING

NO. OF CKT'S.	DIM. "C"	DIM. "D"
2	(16.48/15.60) .643/.614	(15.47/15.34) .609/.604
3	(20.45/19.56) .805/.770	(19.43/18.30) .765/.760
5	(28.37/27.48) 1.117/1.082	(27.36/27.23) L077/1.072

SEE SHEET 1 EC NO: UCP2009-3148 DRAWN BY: DRWNK/PPER CHKD BY: CHYDSS/USEK APP: FSW/TH REV: 2009/07/13 2009/08/05	QUALITY SYMBOLS	GENERAL TOLERANCES (UNLESS SPECIFIED)	DIMENSION STYLE	SCALE	DESIGN UNITS	THIRD ANGLE PROJECTION	
	▽=0	mm INCH	MM/IN	---	INCH	☉	
	▽=0	4 PLACES ± .010 3 PLACES ± .010 2 PLACES ± 0.25 ± .014 1 PLACE ± 0.36	DRAWN BY: POLGAR CHECKED BY: PATEL APPROVED BY: LENZ	DATE: 1986/12/05 DATE: 1986/12/05 DATE: 1986/12/05	TITLE: KK (3.96)/156 TRIFURCON CRIMP TERMINAL HOUSING 6442 SERIES	MATERIAL NO. MOLEX INCORPORATED	SHEET NO. 2 OF 4
	ANGULAR ±1/2°	DRAFT WHERE APPLICABLE MUST REMAIN WITHIN DIMENSIONS	SEE CHART	DOCUMENT NO. SD-6442			

19 18 17 16 15 14 13 12 11 10 9 8 7 6 5 4 3 2 1

