

Typical Applications

The HMC451LC3 is ideal for use as a medium power amplifier for:

- Microwave Radio & VSAT
- Military & Space
- Test Equipment & Sensors
- Fiber Optics
- LO Driver for HMC Mixers

Functional Diagram

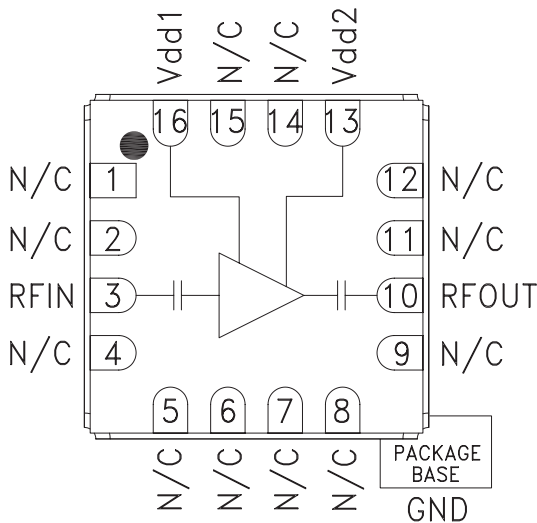

Features

- Gain: 19 dB
- Saturated Power: +21 dBm @ 21% PAE
- Output IP3: +30 dBm
- Single Supply: +5.0 V @ 114 mA
- 50 Ohm Matched Input/Output
- RoHS Compliant 3 x 3mm SMT package

General Description

The HMC451LC3 is an efficient GaAs PHEMT MMIC Medium Power Amplifier housed in a leadless RoHS compliant SMT package. Operating between 5 and 20 GHz, the amplifier provides 19 dB of gain, +21 dBm of saturated power and 21% PAE from a single +5.0V supply. This 50 Ohm matched amplifier does not require any external components and the RF I/O's are DC blocked, making it an ideal linear gain block or driver for HMC SMT mixers. The HMC451LC3 allows the use of surface mount manufacturing techniques.

Electrical Specifications, $T_A = +25^\circ C$, $V_{dd} = +5V$

Parameter	Min.	Typ.	Max.	Min.	Typ.	Max.	Min.	Typ.	Max.	Units
Frequency Range	5 -15			15 - 18			18 - 20			GHz
Gain	16	19		15	18		14	17		dB
Gain Variation Over Temperature		0.015	0.025		0.015	0.025		0.015	0.025	dB/ °C
Input Return Loss		13			13			12		dB
Output Return Loss		12			8			8		dB
Output Power for 1 dB Compression (P1dB)	16.5	19.5		16	19		16.5	19.5		dBm
Saturated Output Power (Psat)		21			20.5			21		dBm
Output Third Order Intercept (IP3)		32			29			29		dBm
Noise Figure		7			6.5			7		dB
Supply Current (Idd)		114			114			114		mA

Broadband Gain & Return Loss

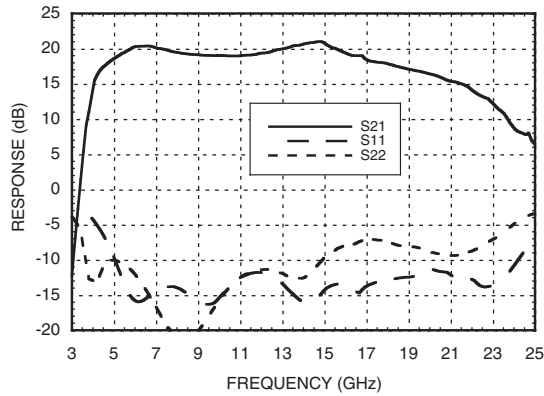

Gain vs. Temperature

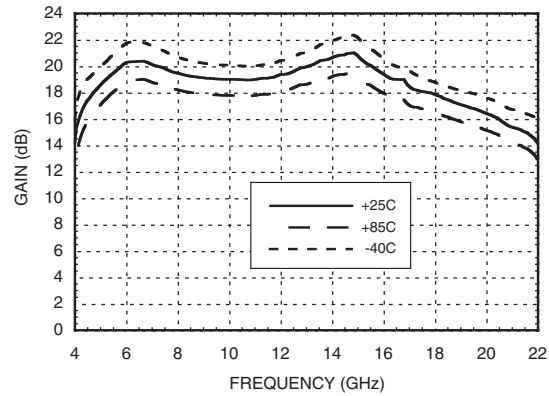

Input Return Loss vs. Temperature

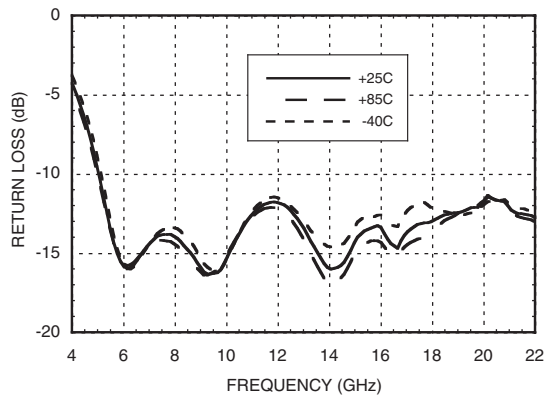

Output Return Loss vs. Temperature

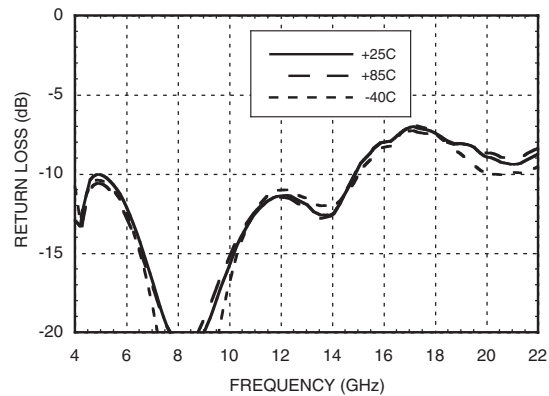

P1dB vs. Temperature

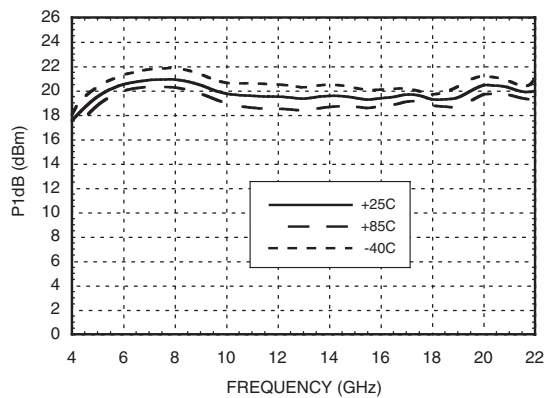

Psat vs. Temperature

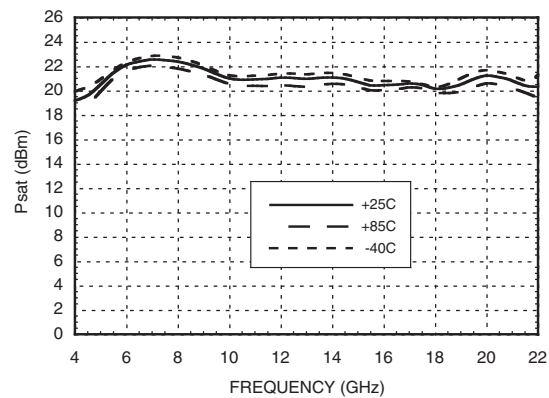



**GaAs PHEMT MMIC MEDIUM
POWER AMPLIFIER, 5 - 20 GHz**

Power Compression @ 10 GHz

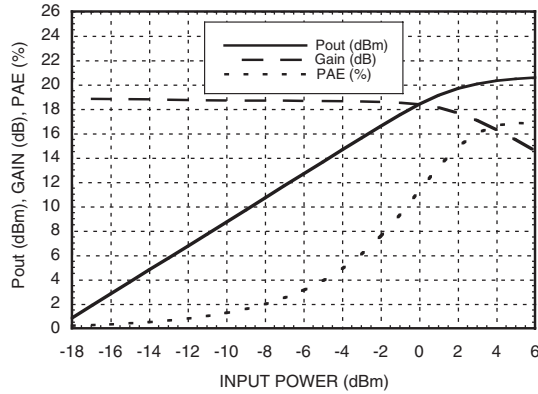

Power Compression @ 20 GHz

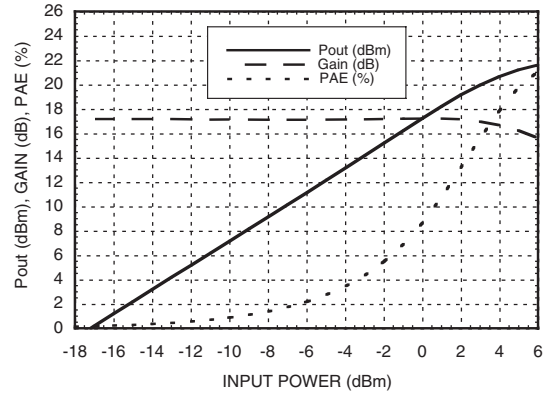

Output IP3 vs. Temperature

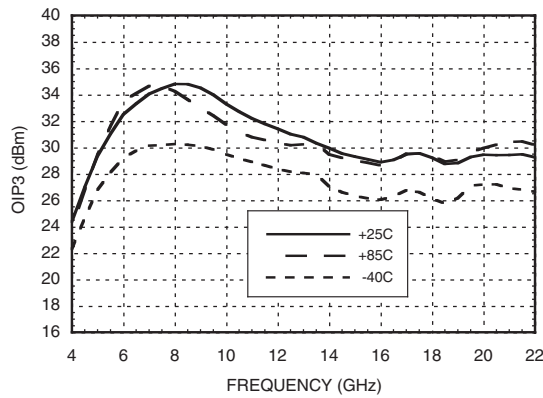

Noise Figure vs. Temperature

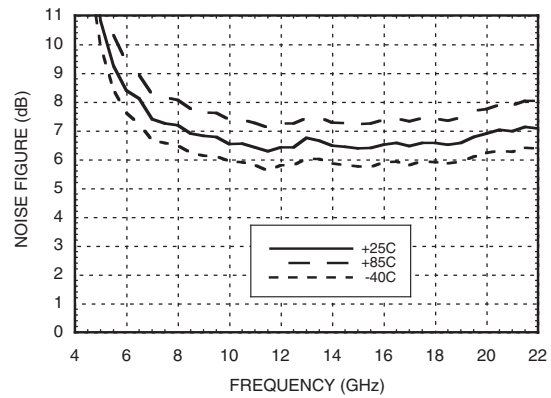

**Gain, P1dB & PSAT
vs. Supply Voltage @ 11 GHz**

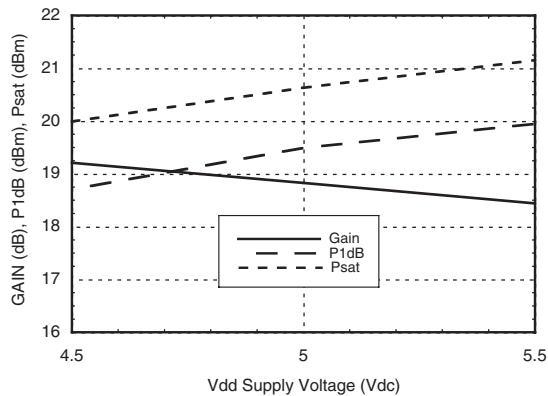

Reverse Isolation vs. Temperature

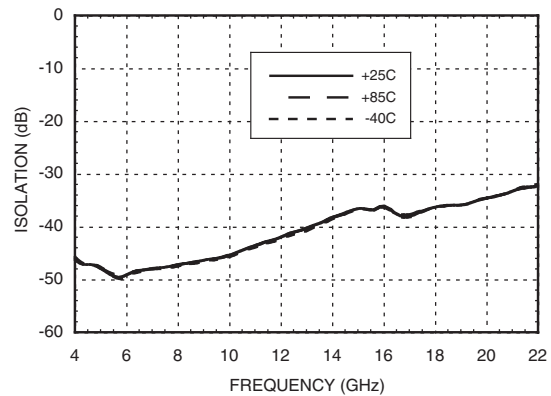

Absolute Maximum Ratings

Drain Bias Voltage (Vdd)	+5.5 Vdc
RF Input Power (RFIn)(Vdd = +5.0 Vdc)	+10 dBm
Channel Temperature	175 °C
Continuous Pdiss (T = 85 °C) (derate 10 mW/°C above 85 °C)	0.9 W
Thermal Resistance (channel to ground paddle)	100 °C/W
Storage Temperature	-65 to +150 °C
Operating Temperature	-40 to +85 °C

Typical Supply Current vs. Vdd

Vdd (V)	Idd (mA)
+4.5	111
+5.0	114
+5.5	116

Note: Amplifier will operate over full voltage range shown above



ELECTROSTATIC SENSITIVE DEVICE
OBSERVE HANDLING PRECAUTIONS

Outline Drawing

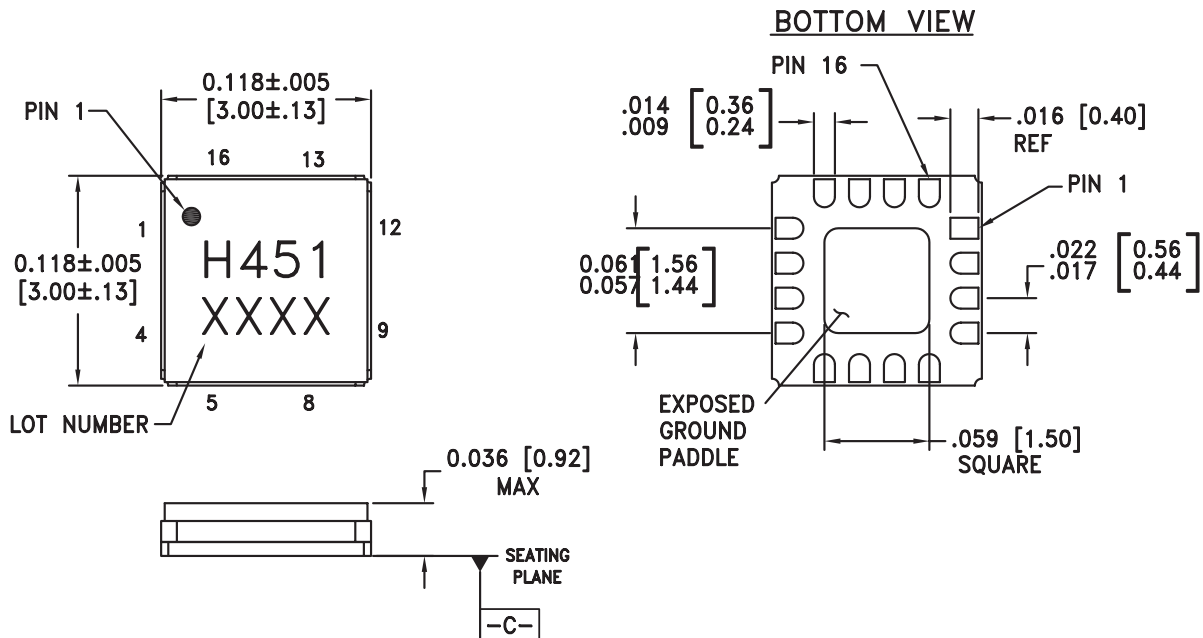



NOTES:

1. PACKAGE BODY MATERIAL: ALUMINA
2. LEAD AND GROUND PADDLE PLATING: 30-80 MICROINCHES GOLD OVER 50 MICROINCHES MINIMUM NICKEL
3. DIMENSIONS ARE IN INCHES [MILLIMETERS].
4. LEAD SPACING TOLERANCE IS NON-CUMULATIVE
5. PACKAGE WARP SHALL NOT EXCEED 0.05mm DATUM -C-
6. ALL GROUND LEADS AND GROUND PADDLE MUST BE SOLDERED TO PCB RF GROUND.

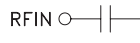
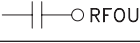
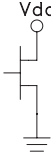

Pin Descriptions

Pin Number	Function	Description	Interface Schematic
1, 2, 4 - 9, 11, 12, 14, 15	N/C	This pin may be connected to RF/DC ground. Performance will not be affected.	
3	RFIN	This pin is AC coupled and matched to 50 Ohms from 5 - 20 GHz.	RFIN 
10	RFOUT	This pin is AC coupled and matched to 50 Ohms from 5 - 20 GHz.	 RFOUT
13	Vdd2	Power Supply Voltage for the amplifier. External bypass capacitors of 100 pF, 1,000 pF and 2.2 μF are required.	
16	Vdd1	Power Supply Voltage for the amplifier. External bypass capacitors of 100 pF, 1,000 pF and 2.2 μF are required.	
	GND	Package bottom must be connected to RF/DC ground.	

Application Circuit

Component	Value
C1, C2	100 pF
C3, C4	1,000 pF
C5, C6	2.2 μF

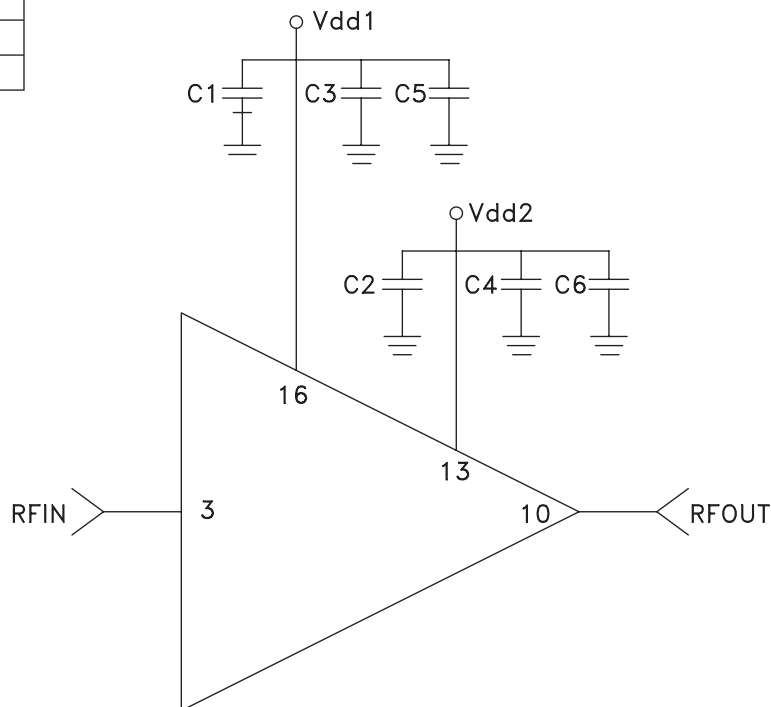

Evaluation PCB

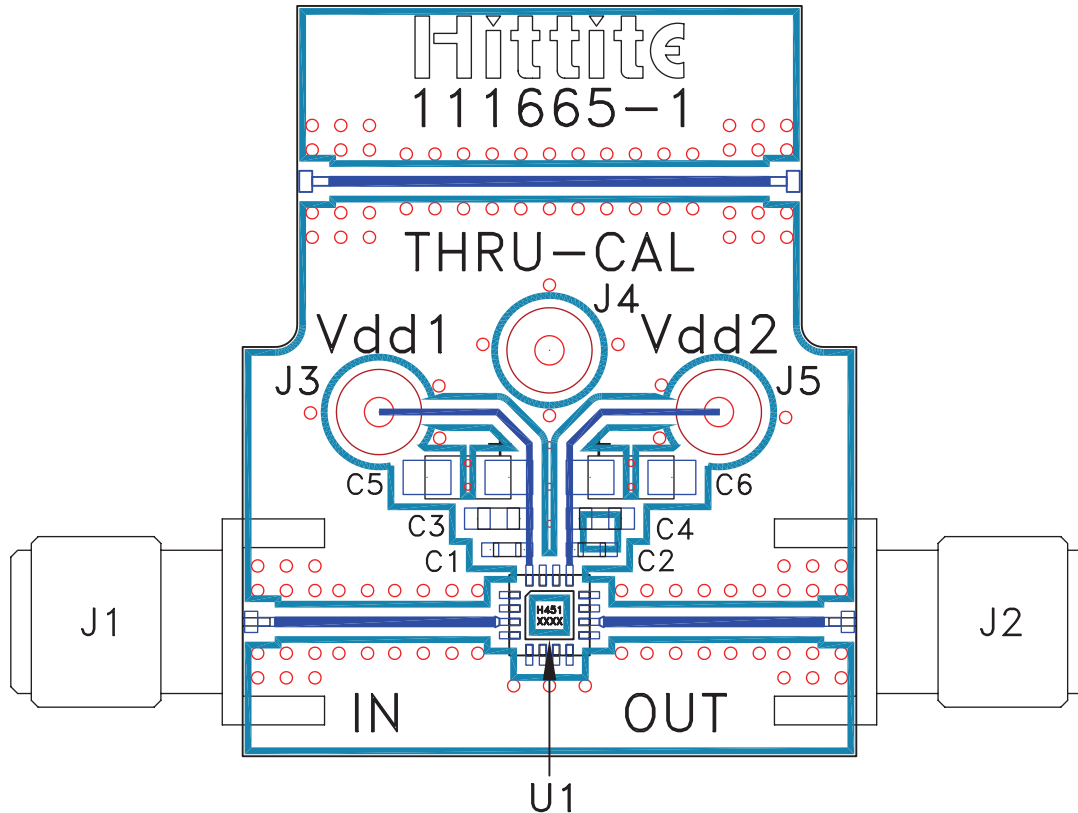

List of Materials for Evaluation PCB 111667 [1]

Item	Description
J1 - J2	PCB Mount SMA Connector
J3 - J5	DC Pin
C1, C2	100 pF Capacitor, 0402 Pkg.
C3, C4	1000 pF Capacitor, 0603 Pkg.
C5, C6	2.2 μ F Capacitor, Tantalum
U1	HMC451LC3 Amplifier
PCB [2]	111665 Evaluation PCB, 10 mils

[1] Reference this number when ordering complete evaluation PCB

[2] Circuit Board Material: Rogers 4350

The circuit board used in the final application should use RF circuit design techniques. Signal lines should have 50 ohm impedance while the package ground leads and exposed paddle should be connected directly to the ground plane similar to that shown. A sufficient number of VIA holes should be used to connect the top and bottom ground planes. The evaluation board should be mounted to an appropriate heat sink. The evaluation circuit board shown is available from Hittite upon request.