

**J108
J109
J110**

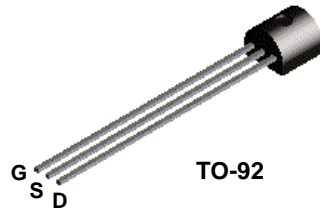

N-Channel Switch

This device is designed for analog or digital switching applications where very low on resistance is mandatory. Sourced from Process 58.

Absolute Maximum Ratings* TA = 25°C unless otherwise noted

Symbol	Parameter	Value	Units
V _{DG}	Drain-Gate Voltage	25	V
V _{GS}	Gate-Source Voltage	- 25	V
I _{GF}	Forward Gate Current	10	mA
T _J , T _{stg}	Operating and Storage Junction Temperature Range	-55 to +150	°C

*These ratings are limiting values above which the serviceability of any semiconductor device may be impaired.

NOTES:

- 1) These ratings are based on a maximum junction temperature of 150 degrees C.
- 2) These are steady state limits. The factory should be consulted on applications involving pulsed or low duty cycle operations.

Thermal Characteristics TA = 25°C unless otherwise noted

Symbol	Characteristic	Max	Units
		J108 / J109 / J110	
P _D	Total Device Dissipation Derate above 25°C	350	mW
		2.8	mW/°C
R _{θJC}	Thermal Resistance, Junction to Case	125	°C/W
R _{θJA}	Thermal Resistance, Junction to Ambient	357	°C/W

N-Channel Switch

(continued)

J108 / J109 / J110

Electrical Characteristics

TA = 25°C unless otherwise noted

Symbol	Parameter	Test Conditions	Min	Max	Units	
OFF CHARACTERISTICS						
$V_{(BR)GSS}$	Gate-Source Breakdown Voltage	$I_G = -10 \mu A, V_{DS} = 0$	-25		V	
I_{GSS}	Gate Reverse Current	$V_{GS} = -15 V, V_{DS} = 0$ $V_{GS} = -15 V, V_{DS} = 0, T_A = 100^\circ C$		-3.0 -200	nA nA	
$V_{GS(off)}$	Gate-Source Cutoff Voltage	$V_{DS} = 15 V, I_D = 10 nA$	J108 J109 J110	-3.0 -2.0 -0.5	-10 -6.0 -4.0	V V V

ON CHARACTERISTICS

I_{DSS}	Zero-Gate Voltage Drain Current*	$V_{DS} = 15 V, I_{GS} = 0$	J108 J109 J110	80 40 10		mA mA mA
$r_{DS(on)}$	Drain-Source On Resistance	$V_{DS} \leq 0.1 V, V_{GS} = 0$	J108 J109 J110		8.0 12 18	Ω Ω Ω

SMALL SIGNAL CHARACTERISTICS

$C_{dg(on)}$ $C_{sg(off)}$	Drain Gate & Source Gate On Capacitance	$V_{DS} = 0, V_{GS} = 0, f = 1.0 MHz$		85	pF
$C_{dg(off)}$	Drain-Gate Off Capacitance	$V_{DS} = 0, V_{GS} = -10 V, f = 1.0 MHz$		15	pF
$C_{sg(off)}$	Source-Gate Off Capacitance	$V_{DS} = 0, V_{GS} = -10 V, f = 1.0 MHz$		15	pF

*Pulse Test: Pulse Width $\leq 300 \mu s$, Duty Cycle $\leq 2.0\%$

Typical Characteristics

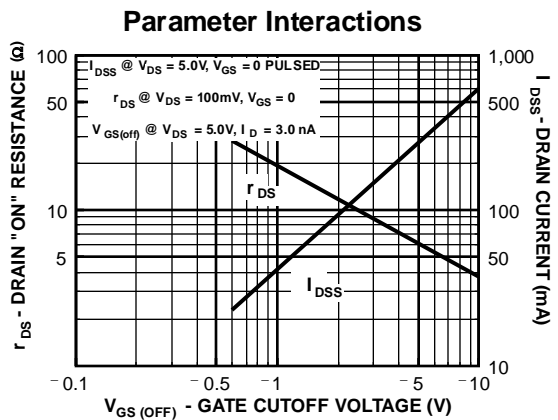
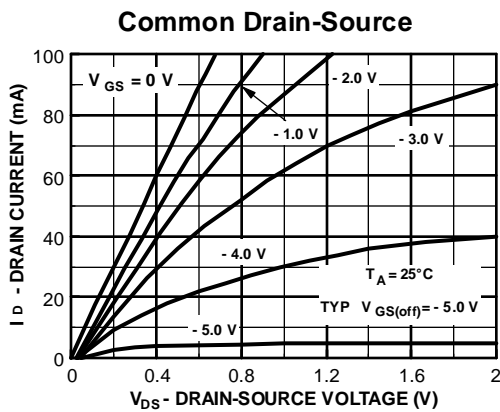

Typical Characteristics (continued)

Common Drain-Source

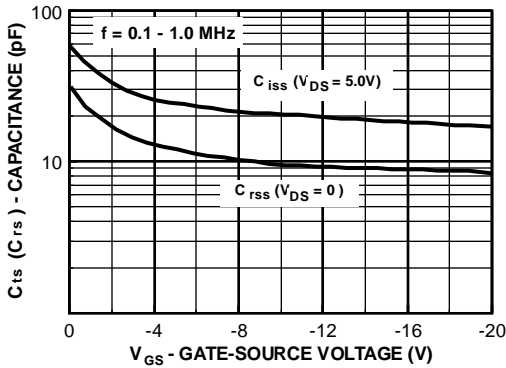

Common Drain-Source

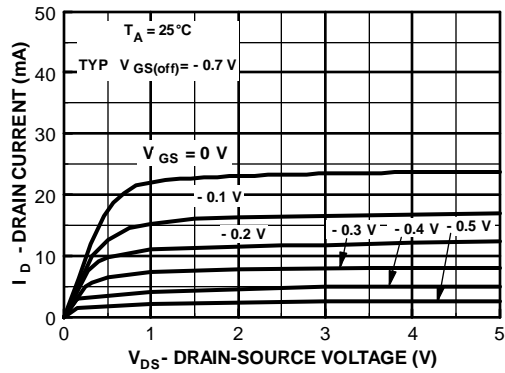

Normalized Drain Resistance vs Bias Voltage

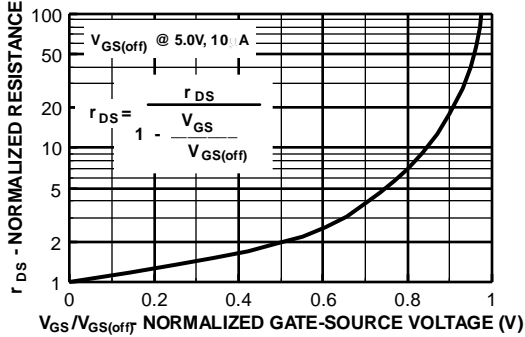

Noise Voltage vs Frequency

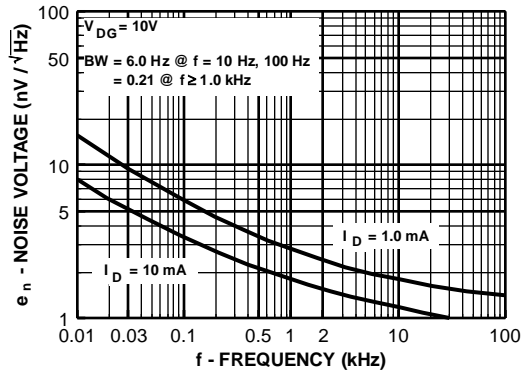

Switching Turn-On Time vs Gate-Source Cutoff Voltage

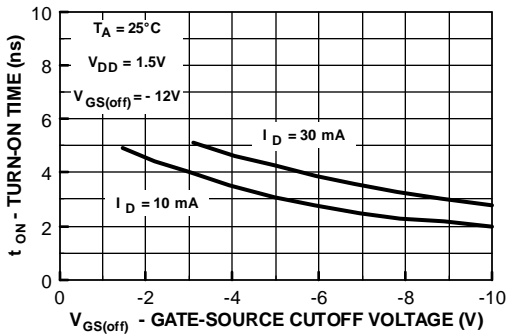

Switching Turn-Off Time vs Drain Current

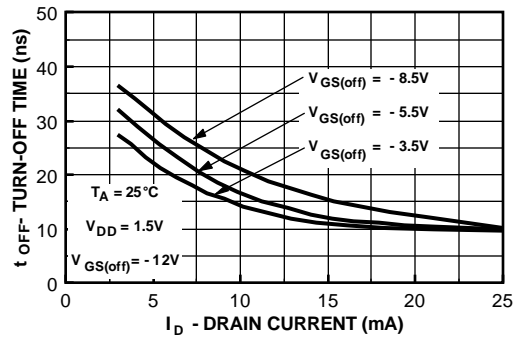

Typical Characteristics (continued)

