

### 描述 / Descriptions

TO-220F 塑封封装 N 沟道 MOS 场效应管。N-CHANNEL MOSFET in a TO-220F Plastic Package.

### 特征 / Features

低栅电荷,低反馈电容,开关速度快。  
Low gate charge, low crss, fast switching.

### 用途 / Applications

用于高效 DC/DC 转换和功率开关。  
These devices are well suited for high efficiency switching DC/DC converters and switch mode power supplies.

### 内部等效电路 / Equivalent Circuit

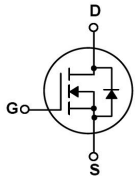

### 引脚排列 / Pinning

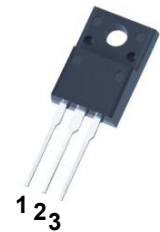

PIN 1 : G      PIN 2 : D      PIN 3 : S

### 放大及印章代码 / $h_{FE}$ Classifications & Marking

见印章说明。 See Marking Instructions.

**极限参数 / Absolute Maximum Ratings(Ta=25°C)**

参数 Parameter	符号 Symbol	数值 Rating	单位 Unit
Drain-Source Voltage	$V_{DSS}$	250	V
Drain Current	$I_D(T_C=25^\circ C)$	8.1	A
Drain Current	$I_D(T_C=100^\circ C)$	5.1	A
Drain Current - Pulsed	$I_{DM}$	32.4	A
Gate-Source Voltage	$V_{GSS}$	±30	V
Single Pulsed Avalanche Energy	$E_{AS}$	200	mJ
Repetitive Avalanche Energy	$E_{AR}$	7.4	mJ
Avalanche Current	$I_{AR}$	8.1	A
Power Dissipation	$P_D(T_C=25^\circ C)$	38	W
Operating and Storage Temperature Range	$T_J, T_{STG}$	-55 to 150	°C

**电性能参数 / Electrical Characteristics(Ta=25°C)**

参数 Parameter	符号 Symbol	测试条件 Test Conditions	最小值 Min	典型值 Typ	最大值 Max	单位 Unit
Drain-Source Breakdown Voltage	$BV_{DSS}$	$V_{GS}=0V$ $I_D=250\mu A$	250			V
Zero Gate Voltage Drain Current	$I_{DSS}$	$V_{DS}=250V$ $V_{GS}=0V$			10	μA
		$V_{DS}=200V$ $T_C=125^\circ C$			100	μA
Gate-Body Leakage Current Forward	$I_{GSS}$	$V_{GS}=\pm 30V$ $V_{DS}=0V$			±0.1	μA
Gate Threshold Voltage	$V_{GS(th)}$	$V_{DS}=V_{GS}$ $I_D=250\mu A$	2.0		4.0	V
Static Drain-Source On-Resistance	$R_{DS(on)}$	$V_{GS}=10V$ $I_D=4.05A$		0.37	0.45	Ω
Forward Transconductance	$g_{FS}$	$V_{DS}=40V$ $I_D=4.05A$		7.5		S
Drain-Source Diode Forward Voltage	$V_{SD}$	$V_{GS}=0V$ $I_S=8.1A$			1.5	V
Input Capacitance	$C_{iss}$	$V_{DS}=25V$ $V_{GS}=0V$ $f=1.0MHz$		735	960	pF
Output Capacitance	$C_{oss}$			120	155	
Reverse Transfer Capacitance	$C_{rss}$			35	45	
Turn-On Delay Time	$t_{d(on)}$	$V_{DD}=125V$ $I_D=8.1A$ $R_G=25\Omega$		15	40	ns
Turn-On Rise Time	$t_r$			85	180	
Turn-Off Delay Time	$t_{d(off)}$			80	170	
Turn-Off Fall Time	$t_f$			60	130	

**电参数曲线图 / Electrical Characteristic Curve**

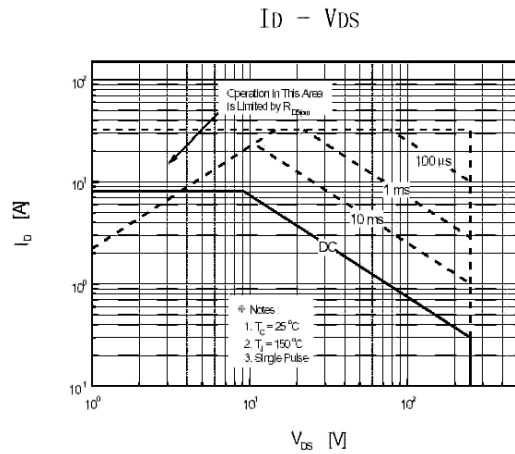
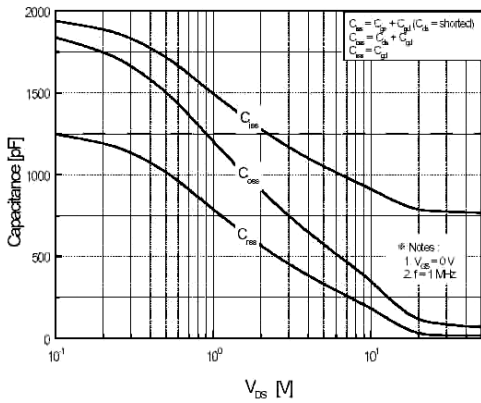
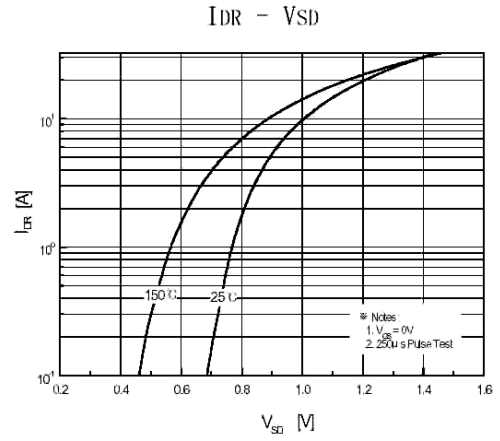
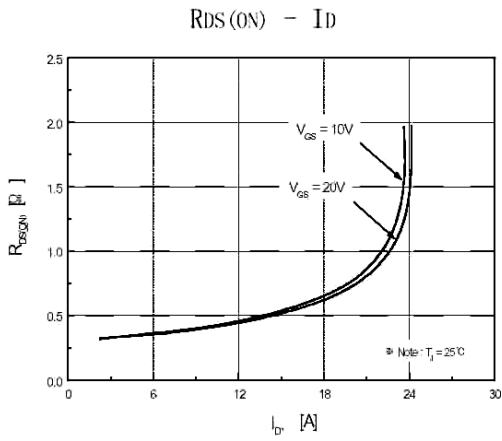
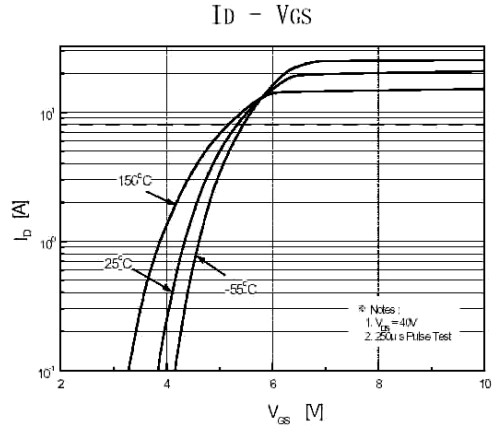
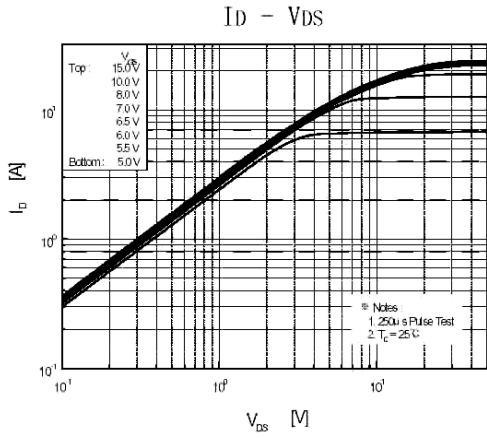

电参数曲线图 / Electrical Characteristic Curve

BVDSS - T<sub>J</sub>

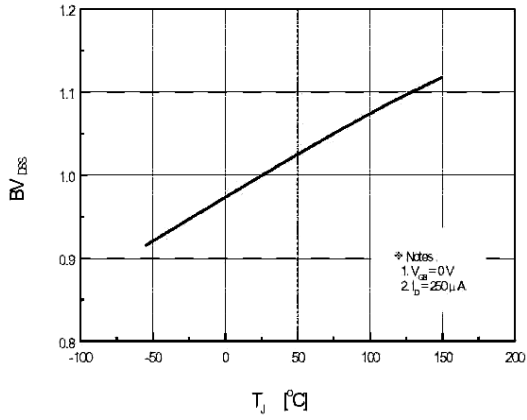

R<sub>DS(on)</sub> - T<sub>J</sub>

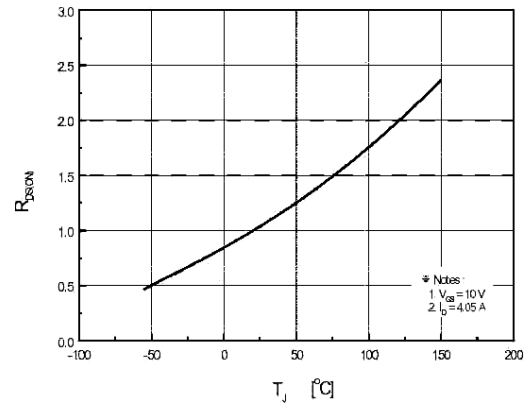

I<sub>D</sub> - T<sub>C</sub>

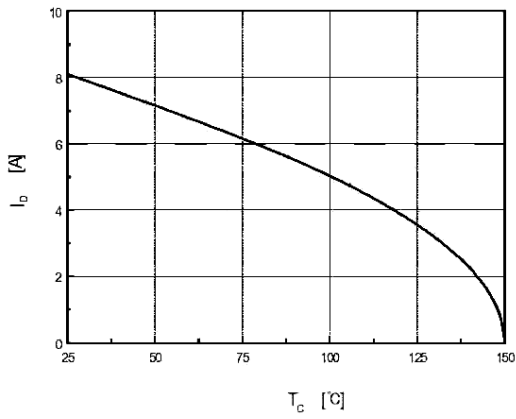

外形尺寸图 / Package Dimensions

TO-220F

单位: mm

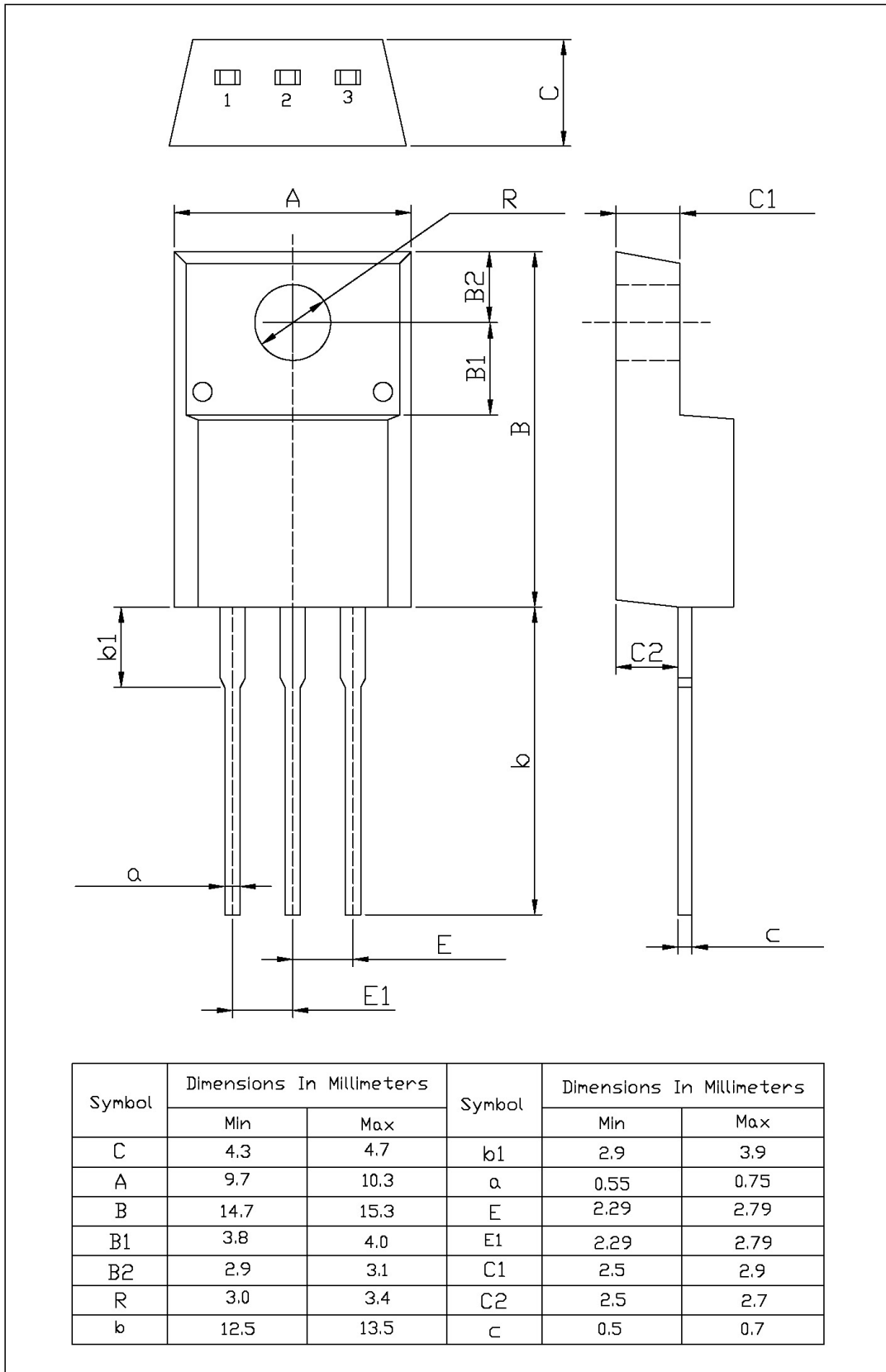

**印章说明 / Marking Instructions**

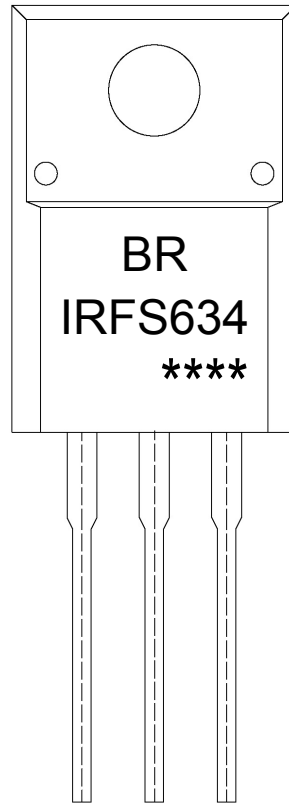

说明：

BR： 为公司代码

IRFS634： 为产品型号

\*\*\*\*： 为生产批号代码，随生产批号变化。

Note:

BR: Company Code

IRFS634: Product Type.

\*\*\*\*: Lot No. Code, code change with Lot No.

**波峰焊温度曲线图(无铅) / Temperature Profile for Dip Soldering(Pb-Free)**

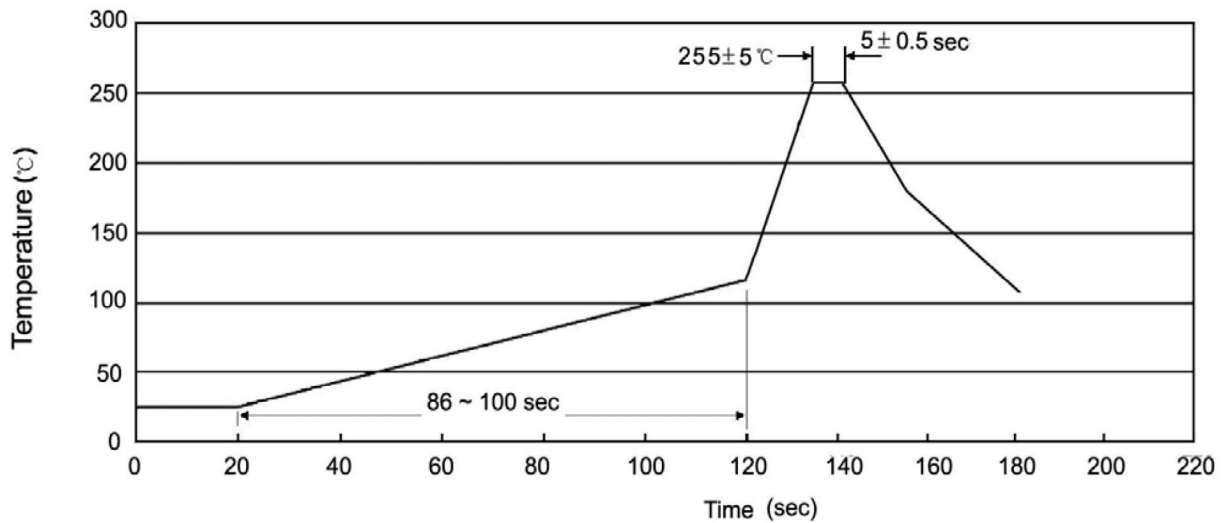

说明：

- 1、预热温度 25 ~ 150°C，时间 60 ~ 90sec；
- 2、峰值温度 255±5°C，时间持续为 5±0.5sec；
- 3、焊接制程冷却速度为 2 ~ 10°C/sec.

Note:

- 1.Preheating:25~150°C, Time:60~90sec.
- 2.Peak Temp.:255±5°C, Duration:5±0.5sec.
3. Cooling Speed: 2~10°C/sec.

**耐焊接热试验条件 / Resistance to Soldering Heat Test Conditions**

温度：270±5°C      时间：10±1 sec.      Temp.:270±5°C      Time:10±1 sec

**包装规格 / Packaging SPEC.**

散件包装 / BULK

Package Type 封装形式	Units 包装数量					Dimension 包装尺寸 (unit: mm <sup>3</sup> )		
	Units/Bag 只/袋	Bags/Inner Box 袋/盒	Units/Inner Box 只/盒	Inner Boxes/Outer Box 盒/箱	Units/Outer Box 只/箱	Bag 袋	Inner Box 盒	Outer Box 箱
TO-220/F	200	10	2,000	5	10,000	135×190	237×172×102	560×245×195

套管包装 / TUBE

Package Type 封装形式	Units 包装数量					Dimension 包装尺寸 (unit: mm <sup>3</sup> )		
	Units/Tube 只/套管	Tubes/Inner Box 套管/盒	Units/Inner Box 只/盒	Inner Boxes/Outer Box 盒/箱	Units/Outer Box 只/箱	Tube 套管	Inner Box 盒	Outer Box 箱
TO-220/F	50	20	1,000	5	5,000	532×31.4×5.5	555×164×50	575×290×180

**使用说明 / Notices**