

HSCH-53xx Series

Beam Lead Schottky Diodes for Mixers and Detectors
(1-26 GHz)



Data Sheet

Description

These beam lead diodes are constructed using a metal-semiconductor Schottky barrier junction. Advanced epitaxial techniques and precise process control insure uniformity and repeatability of this planar passivated microwave semiconductor. A nitride passivation layer provides immunity from contaminants which could otherwise lead to I_R drift.

The Avago beam lead process allows for large beam anchor pads for rugged construction (typical 6 gram pull strength) without degrading capacitance.

Applications

The beam lead diode is ideally suited for use in stripline or microstrip circuits. Its small physical size and uniform dimensions give it low parasitics and repeatable RF characteristics through K-band.

The basic medium barrier devices in this family are DC tested HSCH-5310 and -5312. Equivalent low barrier devices are HSCH-5330 and -5332. Batch matched versions are available as HSCH-5331.

The HSCH-5340 is selected for applications requiring guaranteed RF-tested performance up to 26 GHz. The HSCH-5314 is rated at 7.2 dB maximum noise figure at 16 GHz.

Assembly Techniques

Thermocompression bonding is recommended. Welding or conductive epoxy may also be used. For additional information, see Application Note 979, *The Handling and Bonding of Beam Lead Devices Made Easy*, or Application Note 993, *Beam Lead Device Bonding to Soft Substances*.

Features

- **Platinum tri-metal system**
High temperature stability
- **Silicon nitride passivation**
Stable, reliable performance
- **Low noise figure**
Guaranteed 7.5 dB at 26 GHz
- **High uniformity**
Tightly controlled process insures uniform RF characteristics
- **Rugged construction**
4 grams minimum lead pull
- **Low capacitance**
0.10 pF max. at 0 V
- **Polyimide scratch protection**

Outline 07

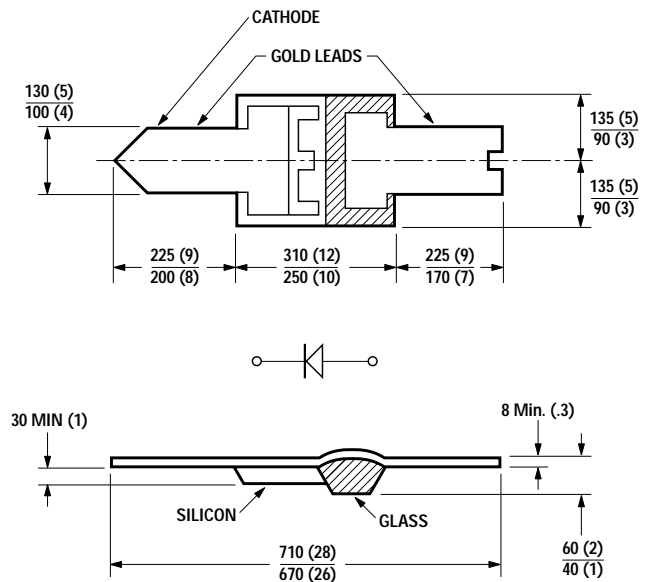

DIMENSIONS IN μm (1/1000 inch)

Maximum Ratings

Pulse Power Incident at $T_A = 25^\circ\text{C}$ 1 W
 Pulse Width = 1 ms, $D_u = 0.001$
 CW Power Dissipation at $T_A = 25^\circ\text{C}$ 150 mW
*Measured in an infinite heat sink derated linearly
 to zero at maximum rated temperature*
 T_{OPR} – Operating Temperature Range -65°C to $+175^\circ\text{C}$
 T_{STG} – Storage Temperature Range -65°C to $+200^\circ\text{C}$
 Minimum Lead Strength 4 grams pull on any lead
 Diode Mounting Temperature $+350^\circ\text{C}$ for 10 sec. max.

These diodes are ESD sensitive. Handle with care to avoid static discharge through the diode.

Table IA. Electrical Specifications for RF Tested Diodes at $T_A = 25^\circ\text{C}$

Part Number HSCH-	Barrier	Max. Noise Figure NF (dB)	I_F Impedance Z_{IF} (Ω)		Max. SWR	Min. Break-down Voltage V_{BR} (V)	Max. Dynamic Resistance R_D (Ω)	Max. Total Capacitance C_T (pF)	Max. Forward Voltage V_F (mV)	Max. Leakage Current I_R (nA)
			Min.	Max.						
5314	Medium	7.2 at 16 GHz	200	400	1.5:1	4	16	0.15	500	100
5340	Low	7.5 at 26 GHz	150	350			20	0.10	375	400
Test Conditions			DC Load Resistance - $0\ \Omega$ LO Power = 1 mW $I_F = 30\ \text{MHz}$, 1.5 dB NF			$I_R \leq 10\ \mu\text{A}$	$I_F = 5\ \text{mA}$	$V_R = 0\ \text{V}$ $f = 1\ \text{MHz}$	$I_F = 1\ \text{mA}$	$V_R = 1\ \text{V}$

*Minimum batch size 20 units.

Note:

1. $C_T = C_J + 0.02\ \text{pF}$ (fringing cap).

Table IB. Electrical Specifications for DC Tested Diodes at $T_A = 25^\circ\text{C}$

Part Number HSCH-	Batch* Matched HSCH-	Barrier	Minimum Breakdown Voltage V_{BR} (V)	Maximum Dynamic Resistance R_D (Ω)	Maximum Total Capacitance C_T (pF)	Maximum Forward Voltage V_F (mV)	Maximum Leakage Current I_R (nA)
5312 5310		Medium	4	16 20	0.15 0.10	500	100
5332 5330	5331	Low	4	16 20	0.15 0.10	375	400
Test Conditions	$\Delta V_F \leq 15$ mV @ 5 mA		$I_R \leq 10$ μA	$I_F = 5$ mA	$V_R = 0$ V $f = 1$ MHz	$I_F = 1$ mA	$V_R = 1$ V

*Minimum batch size 20 units.

Typical Detector Characteristics at $T_A = 25^\circ\text{C}$

Medium Barrier and Low Barrier (DC Bias)

Parameter	Symbol	Typical Value	Units	Test Conditions
Tangential Sensitivity	TSS	-54	dBm	20 μA Bias, $R_L = 100$ k Ω Video Bandwidth = 2 MHz $f = 10$ GHz
Voltage Sensitivity	γ	6.6	mV/ μW	
Video Resistance	R_V	1400	Ω	

Low Barrier (Zero Bias)

Parameter	Symbol	Typical Value	Units	Test Conditions
Tangential Sensitivity	TSS	-44	dBm	Zero Bias, $R_L = 10$ M Ω Video Bandwidth = 2 MHz $f = 10$ GHz
Voltage Sensitivity	γ	10	mV/ μW	
Video Resistance	R_V	1.8	M Ω	

SPICE Parameters

Parameter	Units	HSCH-5312 HSCH-5314	HSCH-5310	HSCH-5330 HSCH-5340	HSCH-5332
B_V	V	5	5	5	5
C_{J0}	pF	0.13	0.09	0.09	0.13
E_G	eV	0.69	0.69	0.69	0.69
I_{BV}	A	10E-5	10E-5	10E-5	10E-5
I_S	A	3 x 10E-10	3 x 10E-10	4 x 10E-8	4 x 10E-8
N		1.08	1.08	1.08	1.08
R_S	Ω	9	13	13	9
P_B	V	0.65	0.65	0.5	0.5
P_T		2	2	2	2
M		0.5	0.5	0.5	0.5

Typical Parameters

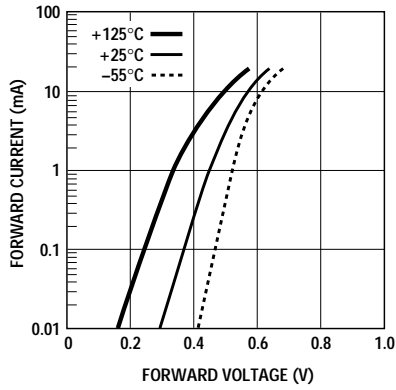

Figure 1. Typical forward characteristics for medium barrier beam lead diodes. HSCH-5310 series.

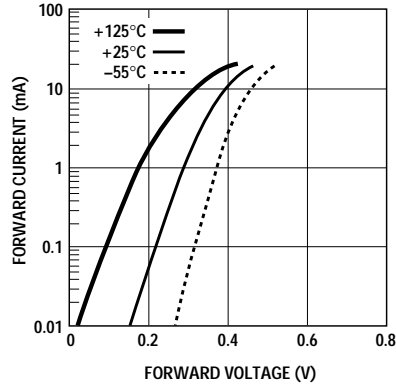

Figure 2. Typical forward characteristics for low barrier beam lead diodes. HSCH-5330, -5340 series.

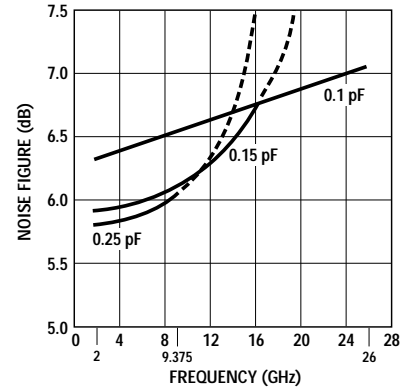

Figure 3. Typical noise figure vs. frequency.

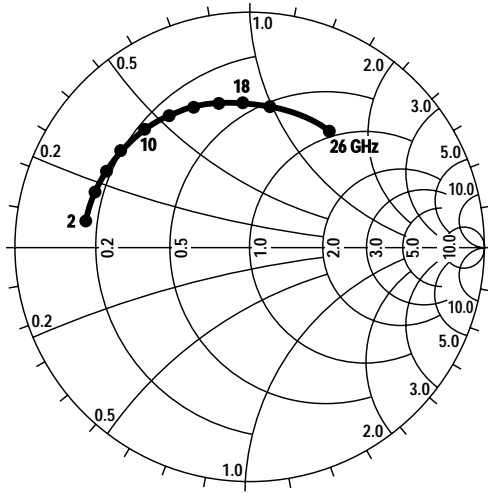

Figure 4. Typical admittance characteristics with 1 mA self bias. HSCH-5340.

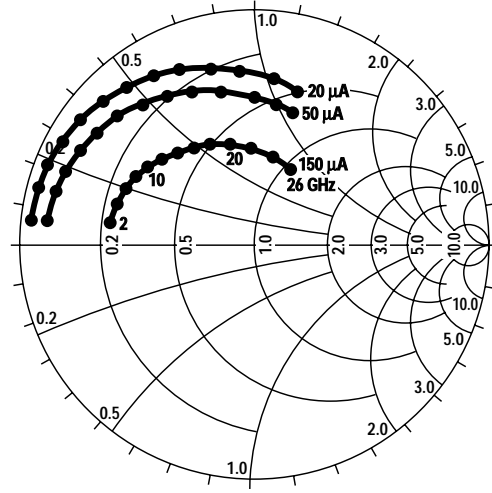

Figure 5. Typical admittance characteristics with external bias. HSCH-5340.

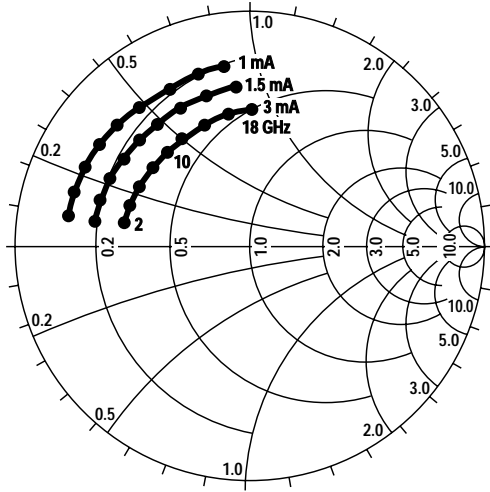

Figure 6. Typical admittance characteristics with self bias. HSCH-5314.

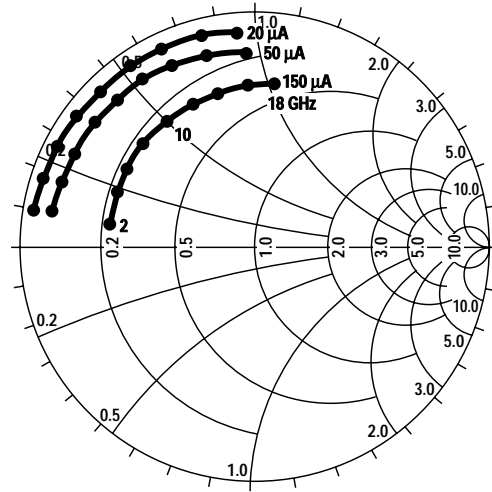
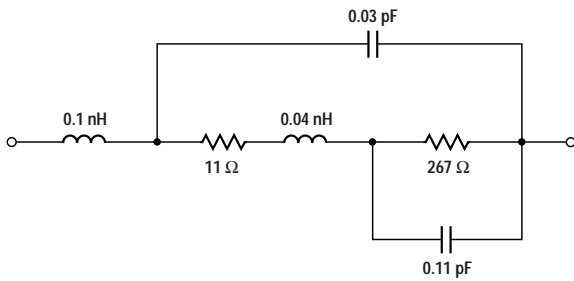

Figure 7. Typical admittance characteristics with external bias. HSCH-5314.

Models for Each Beam Lead Schottky Diode

HSCH-5340

1 mA Self Bias



Other HSCH-53xx

Self Bias

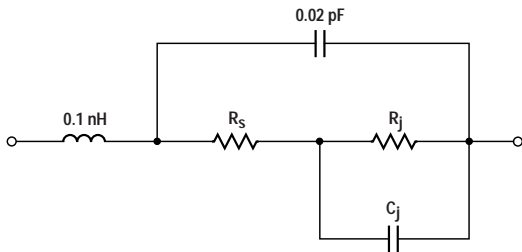

Part Numbers	1.0 mA Self Bias			1.5 mA Self Bias			3.0 mA Self Bias		
	R_S (Ω)	R_J (Ω)	C_J (pF)	R_S (Ω)	R_J (Ω)	C_J (pF)	R_S (Ω)	R_J (Ω)	C_J (pF)
HSCH-5314	5.0	393	0.11	5.2	232	0.11	5.0	150	0.12

HSCH-5340

External Bias

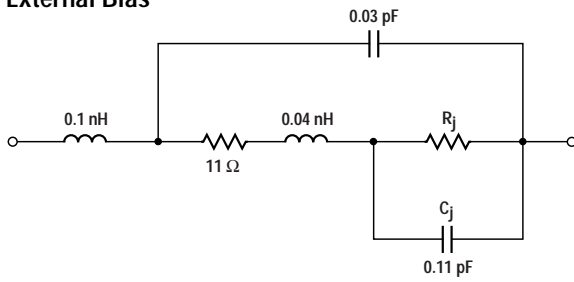

Part Numbers	20 μ A DC Bias		50 μ A DC Bias		150 μ A DC Bias	
	R_j (Ω)	C_j (pF)	R_j (Ω)	C_j (pF)	R_j (Ω)	C_j (pF)
HSCH-5340	1300	0.09	560	0.09	187	0.10

Other HSCH-53xx

External Bias

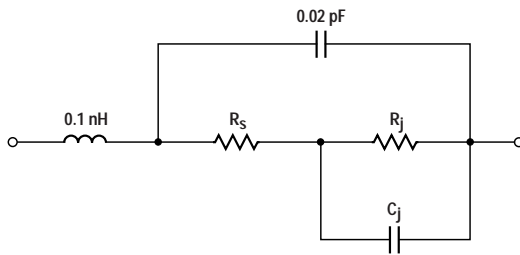

Part Numbers	20 μ ADC Bias			50 μ ADC Bias			150 μ ADC Bias		
	R_s (Ω)	R_j (Ω)	C_j (pF)	R_s (Ω)	R_j (Ω)	C_j (pF)	R_s (Ω)	R_j (Ω)	C_j (pF)
HSCH-5314	2.8	1300	0.11	4.7	520	0.12	2.7	180	0.13

For product information and a complete list of distributors, please go to our website: www.avagotech.com

Avago, Avago Technologies, and the A logo are trademarks of Avago Technologies Limited in the United States and other countries. Data subject to change. Copyright © 2006 Avago Technologies Pte. All rights reserved. Obsoletes AV01-0127EN AV01-0484EN September 21, 2006

AVAGO
TECHNOLOGIES