

Title	<i>Engineering Prototype Report – 3 W Universal Input TinySwitch[®]-II TNY264 Power Supply</i>
Specification	3 W, (9 V, 0.33 A), 85–265 V _{AC} input
Target Applications	AC Adapters (cordless phones, answering machines and other consumer products)
Author	Power Integrations Applications Dept.
Doc Num.	EPR-000014
Date	22 Feb 2002
Revision	1.3

Features

- Cost effective (minimum parts count and single sided PC board)
- Low Cost EF12.6 transformer (132 kHz operation)
- Compact design: 2.0" x 1.2" x 0.75"
- No-load consumption < 250mW (230 V_{AC})
- Auto-restart function limits overload output power
- Short circuit protected
- Built-in circuitry practically eliminates audible noise (standard varnished transformer)
- ON/OFF control allows simple Zener reference and eliminates the need for loop compensation
- No-load regulation achieved without preload resistor
- Low EMI due to frequency jittering: meets CISPR22B with output capacitively grounded
- Optional under-voltage detect eliminates power-up glitches
- Hysteretic thermal shutdown: Protects power supply and automatically recovers when fault is removed

Table of Contents

1	Introduction.....	3
2	Power Supply Specification	4
3	Schematic.....	5
4	Description.....	5
5	PCB Layout.....	7
6	Bill of Materials	7
7	Transformer Specification.....	8
	7.1 Electrical Specifications	8
	7.2 Materials.....	8
	7.3 Transformer Diagram	9
	7.4 Transformer Construction	9
	7.5 Transformer Sources.....	9
8	Performance Data.....	10
	8.1 Output Regulation	10
	8.2 Efficiency.....	11
	8.3 Standby Power Consumption.....	11
	8.4 Output Overload.....	12
	8.5 Thermal Performance.....	12
	8.6 Conducted Emissions.....	14
	8.7 Acoustic Emissions	16
9	Waveform Scope Plots	18
	9.1 Output Ripple Measurement Results	18
	9.1.1 DC Ripple Measurement Technique.....	19
	9.2 DC Output Load Transient Response	20
	9.2.1 10% to 50% load change, 265 V _{AC}	20
	9.2.2 10% to 100% load change, 265 V _{AC}	20
	9.3 Turn-On Delay and Overshoot.....	21
	9.4 Drain Switching Waveforms	22
	9.4.1 85 V _{AC} , Full load, 132 kHz operation.....	22
	9.4.2 85 V _{AC} , Full load, ~100 kHz operation.....	22
	9.4.3 265 V _{AC} , Full load, 132 kHz operation.....	23
	9.4.4 265 V _{AC} , Full load, ~60 kHz operation.....	23
10	AC Surge and 100 kHz Ring Wave Immunity.....	24
	10.1 Differential Mode Surge Test Results.....	24
	10.2 Common Mode Surge Test Results.....	25
	10.3 Differential Mode 100 kHz Ring Wave Test Results	25
	10.4 Common Mode 100kHz Ring Wave Test Results	26
11	Revision History.....	27

Important Note:

Although the EP14 is designed to satisfy safety isolation requirements, the engineering prototype has not been agency approved. Therefore all testing should be performed using an isolation transformer to provide the AC input to the prototype board.



1 Introduction

This document is an engineering report that describes a 9 V, 0.33 A, 3 W output and universal input power supply utilizing the TNY264P. For evaluation, a fully built and tested prototype (EP14) can be found within the Design Accelerator Kit, DAK-14.

This document contains the power supply specification, schematic, bill of materials and transformer documentation. Typical operating characteristics are presented at the rear of the report and consist of performance curves, tables and waveform photos.

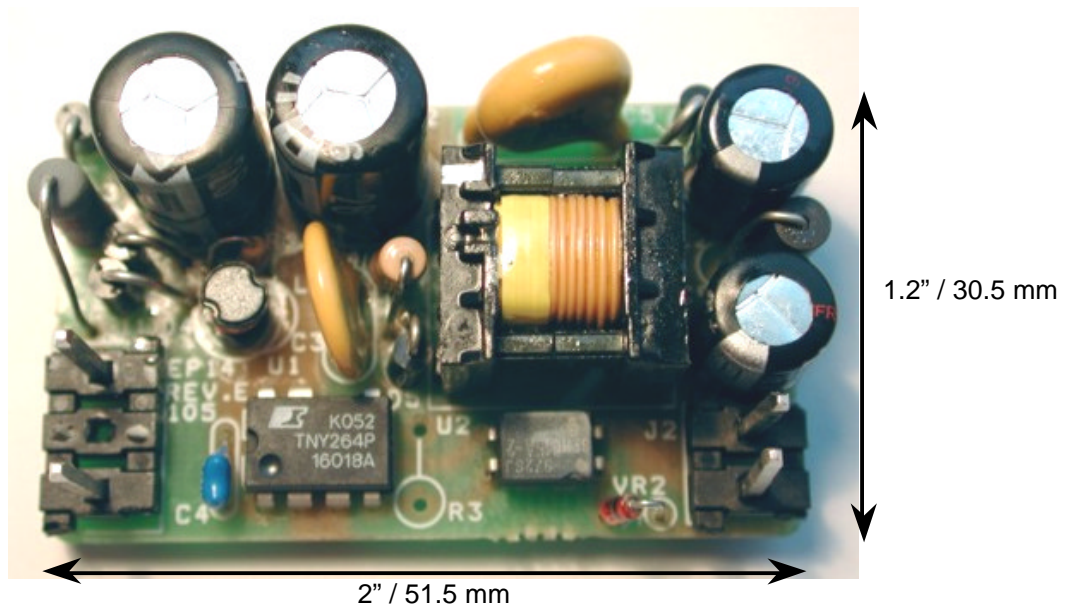

Figure 1. EP14 Populated Circuit Board (approx. 2:1 scale)

2 Power Supply Specification

Description	Symbol	Min	Typ	Max	Units	Comment
Input						
Input Voltage	V_{IN}	85	115/230	265	V_{AC}	
Input Frequency	f_{LINE}	47	50/60	64	Hz	
No-load Input Power (115 V_{AC})				125	mW	
No-load Input Power (230 V_{AC})				250	mW	
Output						
Output Voltage	V_{OUT}	8.37		9.63	V_{DC}^{\dagger}	($\pm 7\%$) At output terminals
Output Ripple Voltage	V_{RIPPLE}			100	mV _{PK-PK}	20 MHz BW
Output Current	I_{OUT}	0		0.33	A	
Continuous Output Power	P_{OUT}	0		3.0	W	
Total Regulation		-2		+2	%	0 – 100% load 85 – 265 V_{AC}
Efficiency	η	67	71			At full load
Environmental						
Conducted EMI						Meets CISPR22 B
Safety						Designed to meet IEC950
External Ambient Temperature	T_{AMB}	0		50	$^{\circ}C$	Natural convection

[†] Output voltage tolerance may be improved through choice of feedback components

Table 1. Power Supply Specification



3 Schematic

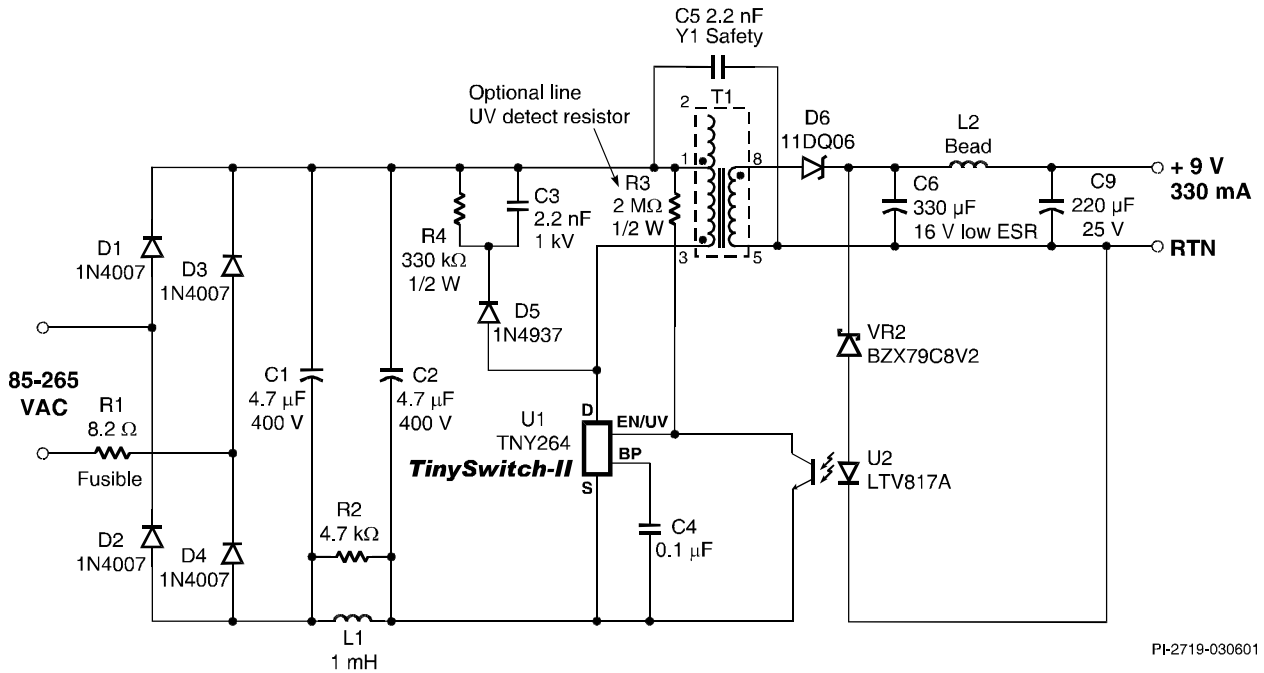

Figure 2. EP14 Power Supply Schematic

4 Description

The EP14 is a single 9 V_{DC} output power supply rated at 3 W. The power supply was designed to operate over an AC input range of 85-265 V_{AC}, 47-64Hz and provides 9 V_{DC} output with $\pm 7\%$ accuracy to no-load. Operating efficiency is 67% worst case at full load across the entire AC line range. Compliance to CISPR22 / EN55022 Class B conducted emissions and surge immunity test level 1 (1 kV, 1.2 / 50 μ S - IEC1000-4-5) is achieved with minimum component count. The unit is designed to comply with international safety standards per IEC950. Minimum parts count enables a space conscious design, with outside dimensions 1.2" x 2.0" x 0.75".

TinySwitch-II provides several advantages in this application. The enhanced ON/OFF control scheme allows tight regulation using a simple, low-cost secondary side Zener reference and no loop compensation. No-load regulation is achieved without a dummy load. The enhanced ON/OFF control scheme dynamically alters the internal current limit as load requirements dictate. This approach reduces cycle skipping when the core flux density is high; thus minimizing acoustic noise. This eliminates the need for special construction, the transformer merely needs to be dip varnished.

Increased operating frequency (132 kHz) allows the use of a small EF12.6 core, while frequency jittering reduces conducted emissions and resulting filtering requirements. These features, combined with primary-side transformer shielding, allows EP14 to comply with CISPR22 B (FCC Class B) emissions without the use of a large, expensive



common mode input choke. Class B emissions are achieved for applications requiring an 'artificial hand' tied to secondary return; which makes this design fully compliant with handheld applications. Standby power consumption is below 250 mW at 230 V_{AC} input.

TinySwitch-II provides greatly reduced device tolerances and incorporates built-in hysteretic overtemperature protection. These features minimize component count while maximizing device power capability. Auto-restart functionality minimizes device thermal stresses during short-circuit conditions; providing performance similar to that available with the *TOPSwitch* families.

A fusible, flameproof resistor (R1) is used in place of a fuse to reduce cost and increase differential mode filtering. This, combined with the π filter formed by L1, C1 and C2 in addition to C5, allows the unit to meet EN55022 B (CISPR22 B) conducted emission standards.

The AC input is rectified and smoothed by D1-4, C1 and C2. The resulting DC bus is applied to one end of the transformer primary. The other end of the primary is connected to the *TinySwitch-II* DRAIN pin. Low cost RCD clamping (R4, C3 & D6) limits the maximum DRAIN voltage to below 700 V due to transformer leakage inductance. C4 provides the local bypass for *TinySwitch-II*. This capacitor is kept charged during the off time of the internal MOSFET, providing the energy to supply the IC.

An optional line sense resistor (R3) implements under-voltage detect. This is accomplished by sensing the DC voltage across the bulk input capacitors (C1 & C2) at power-up. *TinySwitch-II* is disabled until the DC voltage reaches the required level. With R3 as shown (2 M Ω) this occurs at 100 V_{DC}. Under-voltage detect ensures that the outputs are glitch free on power-up and power down, preventing the power supply from starting if the input voltage is too low, and stopping the supply when the output falls out of regulation on power down. *TinySwitch-II* will detect the absence of R3 and disable the under-voltage function if not required.

The secondary is rectified by D6 and C6. Second stage output filtering consists of ferrite bead (L2) and output capacitor (C7) which eliminate high frequency switching noise and reduce output ripple below 100 mVp-p.

VR2 and U2 sense the output voltage. The combined voltage drop of these two components sets the output voltage to 9 V. A 5% Zener was used giving an overall tolerance and regulation variation of $\pm 7\%$. Using a 3% or 2% Zener allows a more tightly controlled output voltage tolerance.



5 PCB Layout

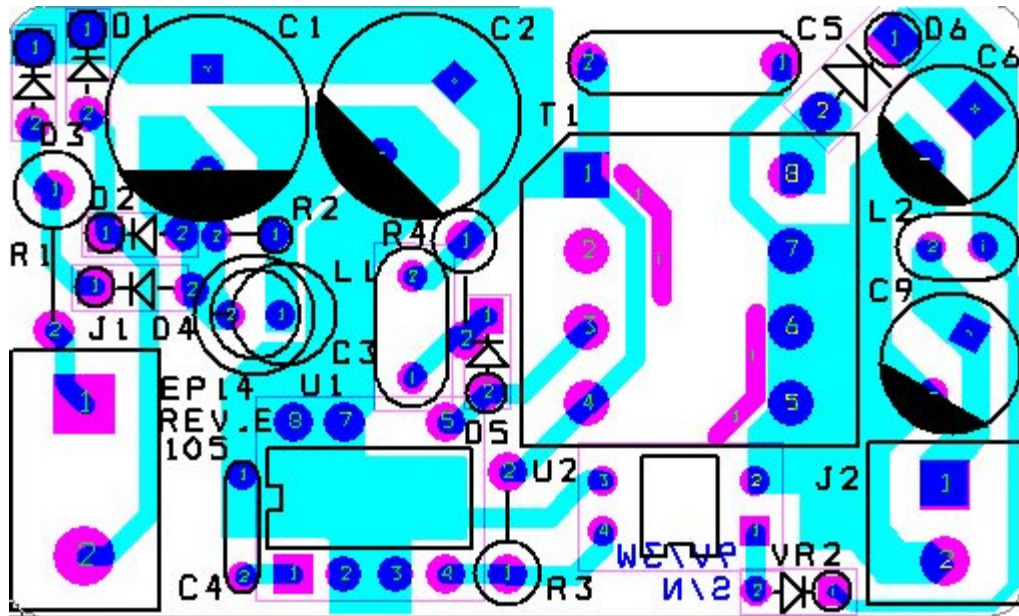

Figure 3. PCB Layout (2.0 × 1.2 × 0.75")

6 Bill of Materials

Item Number	Quantity	Value	Part Reference	Manufacturer
1	2	4.7 uF, 400 V	C1, C2	
2	1	2.2 nF, 1 kV, Z5U	C3	
3	1	0.1 uF, 50 V	C4	
4	1	2200 pF, Y1, 250 V	C5	
5	1	330 uF, 16 V, HFQ	C6	
6	1	220 uF, 25 V, NHE	C9	
7	4	1N4007	D1, D2, D3, D4	
8	1	1N4937, 1 A, 600 V	D5	
9	1	11DQ06, 1.1 A, 60 V	D6	
10	1	1 mH	L1	Tokin
11	1	Bead	L2	Fair-rite
12	1	8R2, fusible, flameproof	R1	Vitrohm
13	1	4.7 kΩ, 1/8W	R2	
14	1	2 MΩ, 1/2W	R3	*optional for UV detect
15	1	330 kΩ, 1/2W	R4	
16	1	Transformer, EF12.6	T1	Hical
17	1	TNY264P	U1	
18	1	LTV817A	U2	
19	1	BZX79-C8V2, 5%	VR2	

Note: assumes 5% resistors



7 Transformer Specification

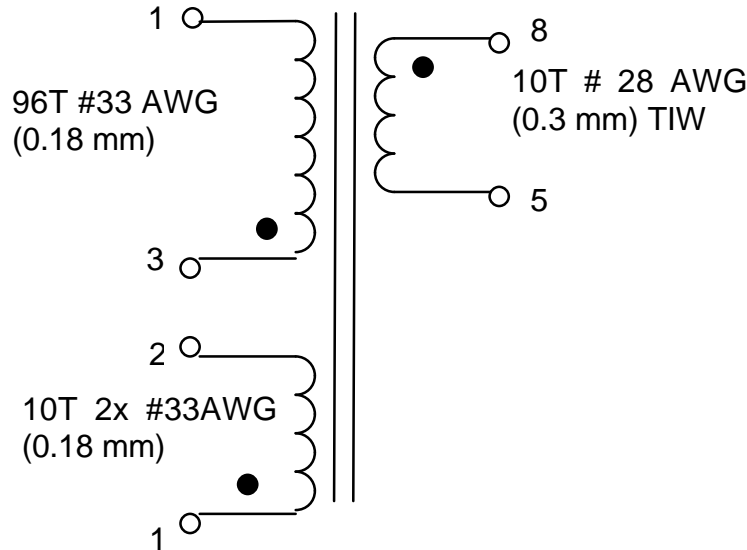

7.1 Electrical Specifications

Electrical Strength	60 Hz 1minute, from Pins 1-3 to Pins 5-8	3000 V _{AC}
Primary Inductance	All windings open, from Pins 1-3	1250 μH ±20%
Resonant Frequency	All windings open, from Pins 1-3	700 kHz (Min.)
Primary Leakage Inductance	Pins 1-3, from Pins 5-8 shorted	< 50 μH

7.2 Materials

Item	Description
[1]	Core: EF12.6, Gapped for AL of 135nH/T ²
[2]	Bobbin: Hical EF12.6, 8P
[3]	Magnet Wire: # 33 AWG (0.18 mm) Double Nyleze
[4]	Magnet Wire: # 28 AWG (0.3 mm) Triple Insulated
[5]	Tape: 3M 1298 Polyester Film (white) 7.8mm wide by 2.2 mils (0.06mm) thick
[6]	Varnish



7.3 Transformer Diagram

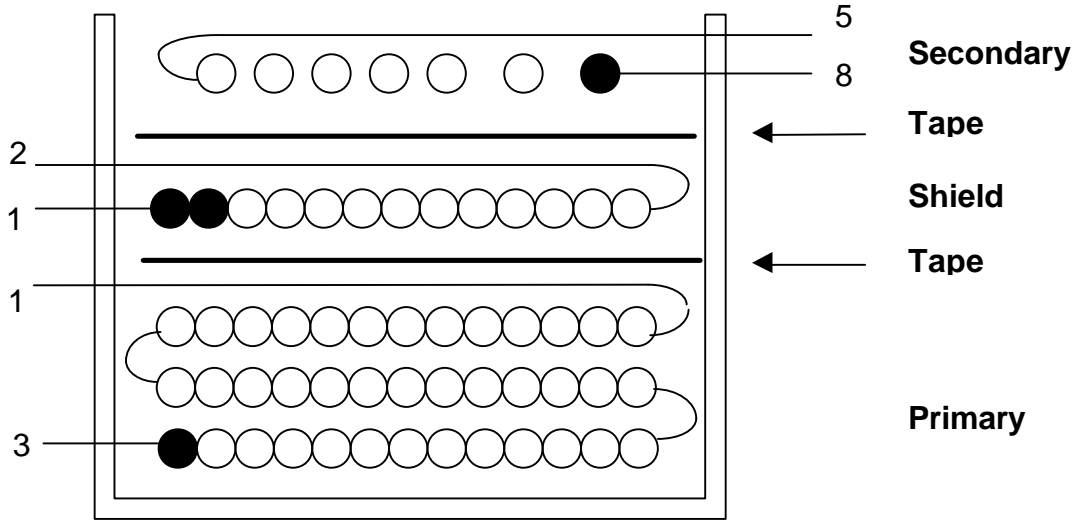

7.4 Transformer Construction

Primary Layer	Start at Pin 3. Wind 33 turns of item [3] from left to right. Wind 33 turns in the next layer from right to left. Wind remaining 30 turns in the next layer from left to right. Finish on Pin 1.
Insulation	1 Layer of tape [5] for insulation.
Shield Winding	Continue at Pin 1. Wind 10 turns of bifilar item [3] from left to right. Wind uniformly, in a single layer, across entire width of bobbin. Finish on Pin 2.
Insulation	1 Layers of tape [5] for insulation.
Secondary Winding	Start at Pin 8. Wind 10 turns of item [4] from right to left. Wind uniformly, in a single layer, across entire width of bobbin. Finish on Pin 5.
Final Assembly	Assemble and secure core halves. Impregnate uniformly (dip varnish) [6] and bake.

7.5 Transformer Sources

For information on the vendors used to source the transformer, please visit our website at the address below and select Engineering Prototype Boards

<http://www.powerint.com/componentsuppliers.htm>



8 Performance Data

Performance data was collected on a single prototype unit (UUT2) at room temperature, unless specified otherwise. Testing was done using a programmable AC generator, Kikusui PLZ-72W electronic load and high resolution AC wattmeter. Details of the test set-up are available in the individual sections.

8.1 Output Regulation

AC source set at 50 Hz with a DC load and a DC ammeter. DC regulation data represents the deviation on the output channel across the full load range (no load – 0 A, ½ load - 0.17 A and full load - 0.33 A) and while varying AC input (85 – 265 V_{AC}). Output voltage transitions may occur when shifting between operating modes; producing a slight deviation to the curve fit presented.

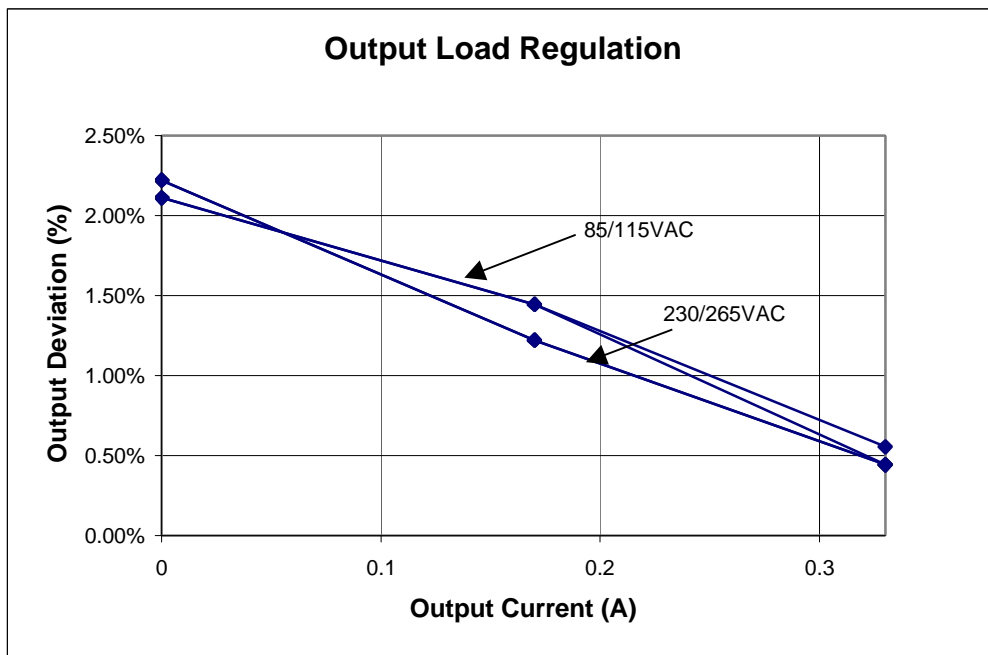

Figure 4. Output Load Regulation vs AC Line Voltage



8.2 Efficiency

Efficiency data was collected at full load while varying the AC input, 50 Hz line frequency. Thermal stabilization was verified. Data represents worst-case efficiency in high frequency operating mode. Due to capacitive switching losses, high voltage efficiency is reduced in high frequency mode (132 kHz).

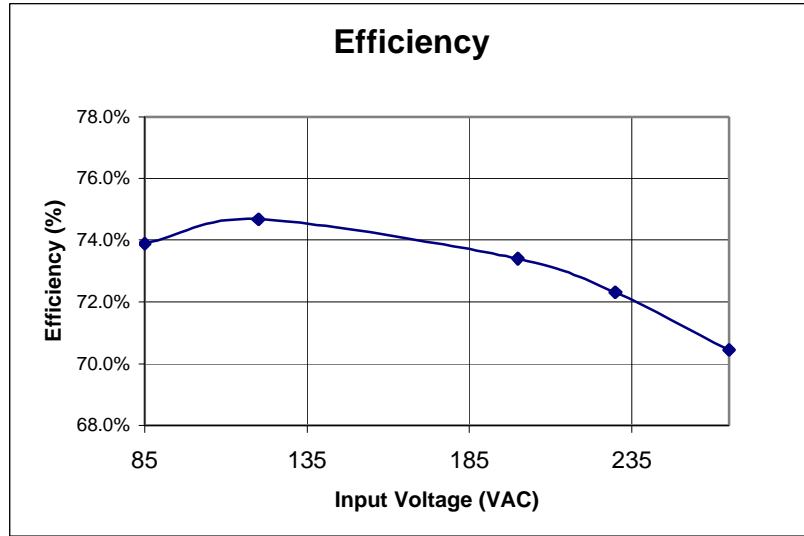

Figure 5. Supply Efficiency vs Line Voltage

8.3 Standby Power Consumption

Standby power was measured with output load disconnected utilizing a high resolution AC wattmeter after the supply had thermally stabilized

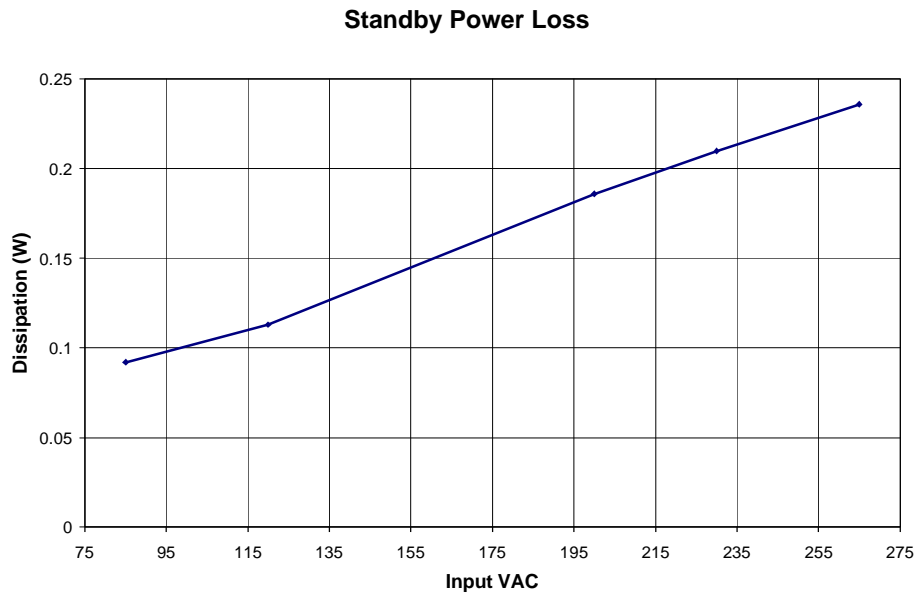

Figure 6. Supply Standby Power vs Line Voltage



8.4 Output Overload

The following curve shows results with the output overload, at room ambient. Output load was adjusted to obtain maximum continuous output current while varying the AC line input. The power supply will operate in auto-restart mode when maximum output current is exceeded. A reduction in maximum output current and input power can be expected as operating temperature is increased.

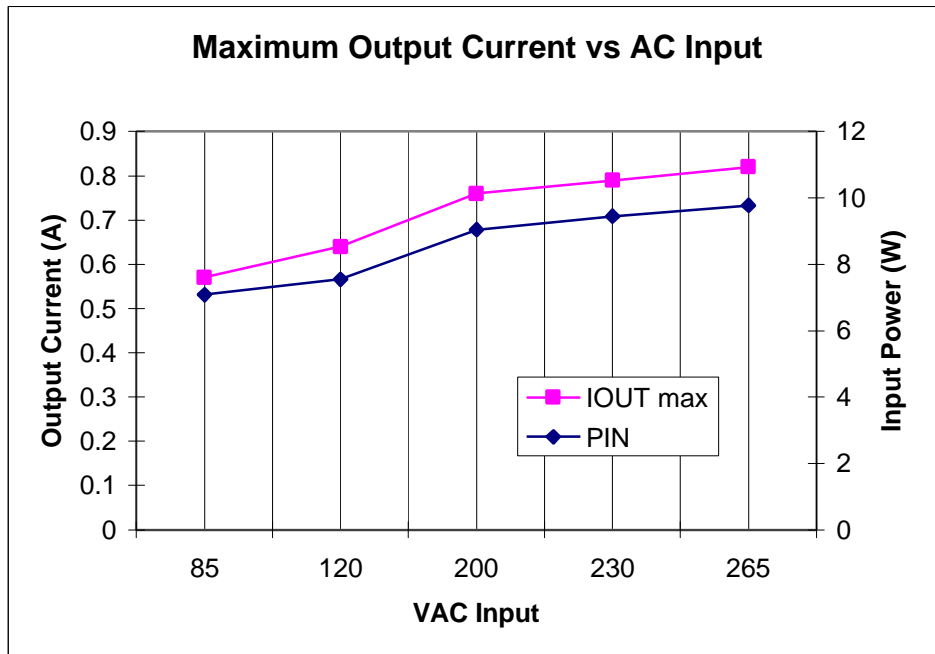

Figure 7. Maximum Output Current vs Line Voltage

8.5 Thermal Performance

Thermal data was collected at room temperature and raised ambient with natural convection, no power supply enclosure, and at a full load of 3 W with the AC line varied. All temperatures were recorded with T-type thermocouples and represent the temperature rise over power supply external ambient, in degrees Celsius (+°C).

- Transformer measured on core, outer leg (glued between core leg and output windings)
- TNY264P soldered to Source lead (pin 2)
- All other thermocouples glued to component body
- Local power supply ambient air temperature was monitored
- The following data represents worst-case dissipation, operating at 132 kHz mode(s)



DAK-14 Component Temperature Rise (+°C)						
V _{AC}	P _{IN} (W)	T _{AMB}	TNY264P	T1 core	L1 inductor	C4 capacitor
85	4.08	25	34.9	26.7	9.5	16.9
115	4.01	25	32.1	26.0	8.9	17.6
230	4.16	25	39.9	28.3	9.5	18.7
265	4.27	25	47.8	31.7	10.2	19.1
85	4.16	50	34.7	21.8	9.8	16.1
265	4.35	50	46.2	27.7	10.0	17.5

Table 2. Key Component Thermal Rise Data

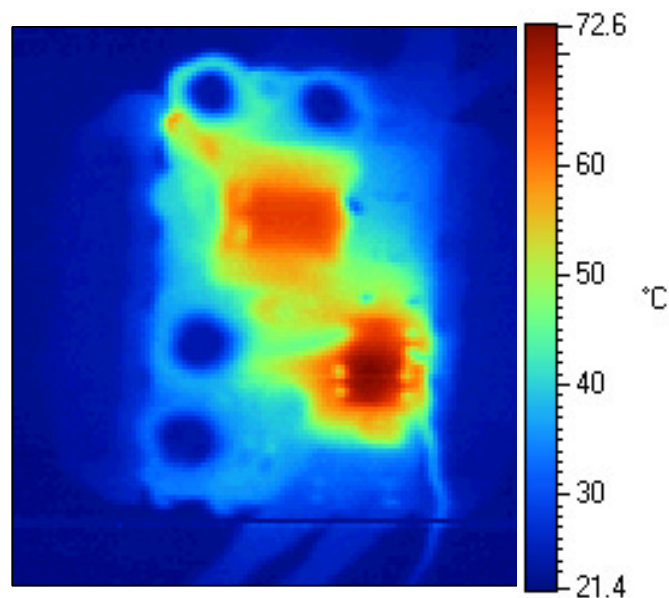

Figure 8. Infra Red Scan of DAK-14, 25 °C Ambient

These results indicate that this is an optimum thermal design. The TNY264 is the hottest component with a 46 °C rise above ambient. This gives an acceptable device temperature of ~100 °C at an external ambient of 50 °C.

8.6 Conducted Emissions

The following conducted emissions scans were recorded operating at full load (resistive 3 W), 115/230 V_{AC}, 60 Hz. A two-wire AC cord was used. In all cases the 'artificial hand' connection of the LISN was tied to secondary side RTN. The worst-case phase was recorded (conducted emissions on alternate phase typically varies 1-2 dB μ V). Rohde & Schwarz Model ESPC receiver and LISN Model ESH3-Z5.

In all cases it was verified that the TNY264 operated at full frequency (132 kHz), to ensure worst-case results.

Line emissions were measured across the frequency range. Pre-scan sweeps for each detector type are presented, Quasi-Peak (top / blue) and Average (bottom / green). Limit lines for CISPR 22 (EN55022) Class B Quasi-Peak (top / red) and Average (bottom / magenta) are visible.

Any peak within 15 dB of the limit line was verified with a 1sec measurement. These results are shown on the scans (Figures 9 & 10) as a red cross (×) or a magenta plus (+).



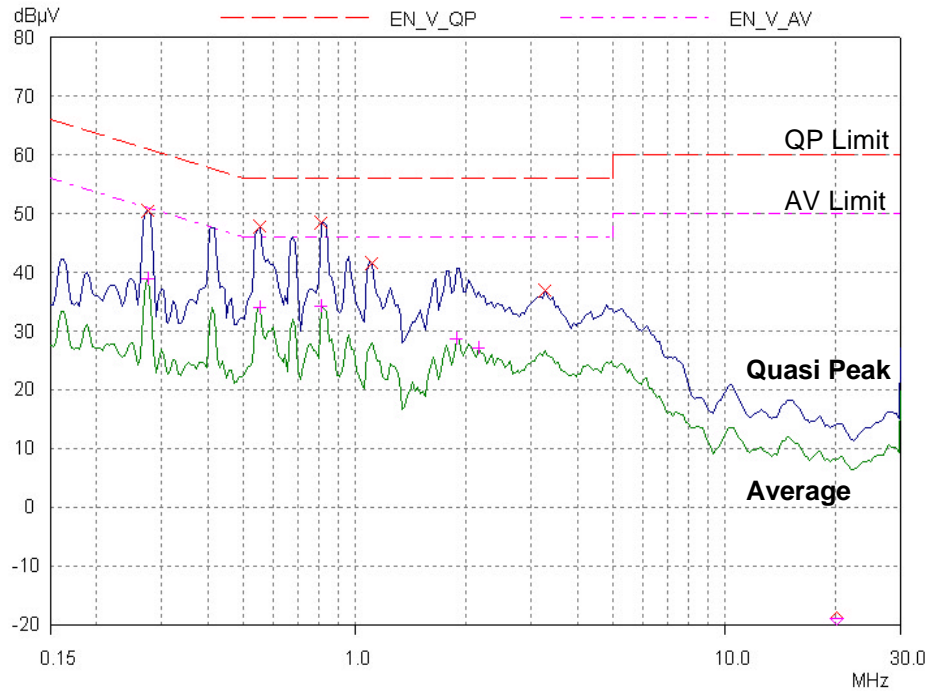

Figure 9. Conducted Emissions, 115 V_{AC} Line

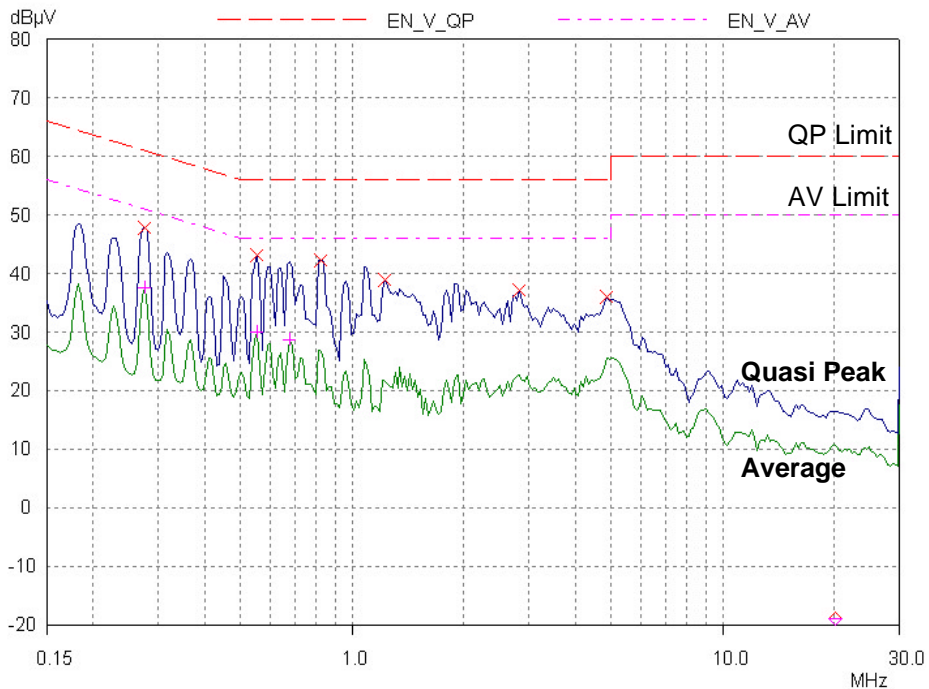

Figure 10. Conducted Emissions, 230 V_{AC} Line

A 2-3 dB μ V reduction in broadband emissions is obtained with the 'artificial hand' disconnected. Increased emissions can be expected with secondary RTN tied to the LISN ground connection (PE).



8.7 Acoustic Emissions

The power supply was subjected to acoustic emissions measurement. The worst-case noise was measured for variations of both AC line and output loading conditions. These results are presented in Figure 12 and Figure 13. In all cases, acoustic emissions were below acceptable levels.

The test unit was placed in an anechoic acoustic chamber, with a microphone located approximately 1" (25 mm) above the transformer (T1) as shown in Figure 11. The power supply was oriented in a horizontal position with the power supply output loaded via an external Kikusui electronic load. The microphone output was fed to an Audio Precision audio analyser to provide the measurements shown.



Figure 11. Test Arrangement for Audio Noise Measurement

The curves shown indicate the spectral content of the noise generated by the supply once the ANSI-A weighting factor has been applied.

The audio limit line (Figure 12, 13) visible at +35 dB represents the generally accepted threshold for power supply audio noise. A discrete audio frequency amplitude was used rather than a dBA value (dBA represents the whole audio spectrum). Large peaks may not raise the dBA value yet can result in unacceptable perceived noise.

As a reference, the approximate dBA background noise floor level is 30 dBA. The microphone sensitivity is such that $20 \mu\text{P} = 0 \text{ dB SPL}$.



Up to a further 20 dB reduction can be expected, from the measurement shown, once the power supply is sealed inside an enclosure.

Audio Precision

FFT SPECTRUM ANALYSIS

02/26/01 10:51:54

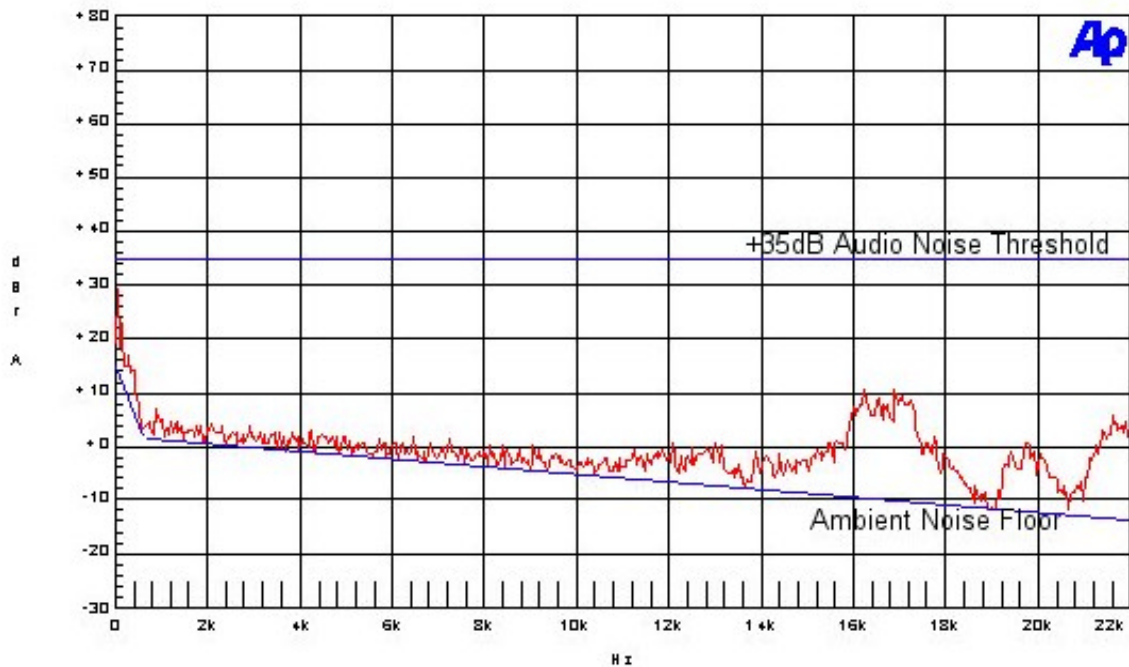

Figure 12. Acoustic Emissions Spectrum, 230 V_{AC} Input, 9 V, 0.21 A Output

Audio Precision

FFT SPECTRUM ANALYSIS

02/26/01 10:49:08

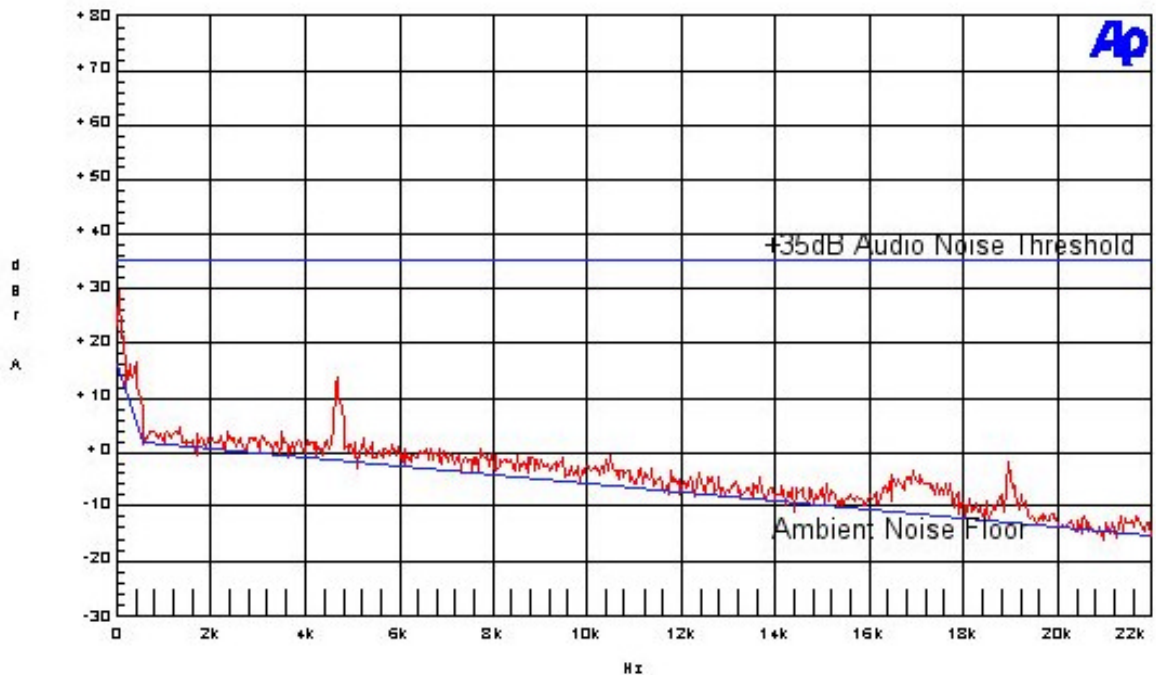

Figure 13. Acoustic Emissions Spectrum, 230 V_{AC} Input, 9 V, 0 A Output



9 Waveform Scope Plots

The following bench data was collected with a Yokogawa DL1540L oscilloscope, Kikusui electronic load and at an AC input frequency of 50 Hz.

9.1 Output Ripple Measurement Results

Output ripple measurement at worst-case 265 V_{AC} is presented across the loading range, 20 MHz oscilloscope bandwidth. In all cases, output ripple is maintained below 100 mVp-p. See Figure 15 for details of scope probe. The output ripple waveshape is a function of AC input voltage and load and may vary with the TNY264 operating mode.

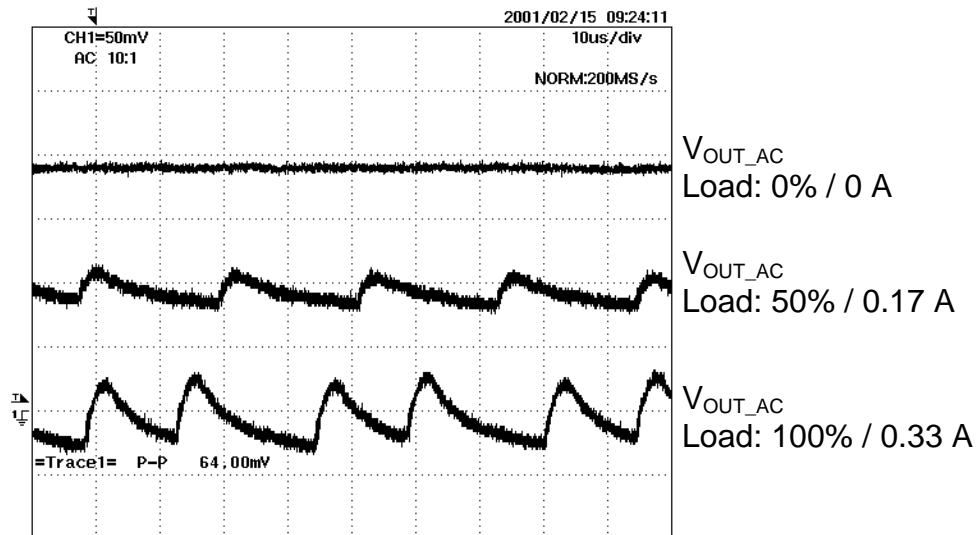

Figure 14. Output Ripple (265 V_{AC}, 0 A, 0.17 A & 0.33 A Loading, 50 mV/div)



9.1.1 DC Ripple Measurement Technique

Details of output ripple probe are provided below. Decoupling capacitors are included to minimize the effects of high frequency probe coupling and ensure a consistent measurement setup.

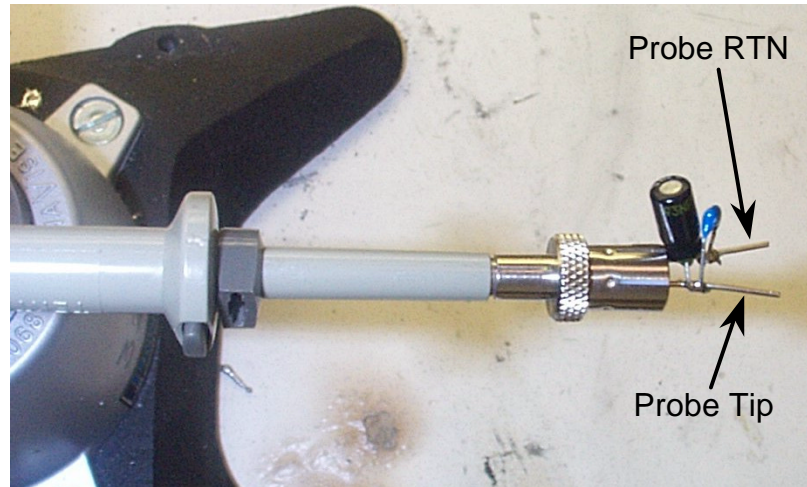

Figure 15. Tektronix P6105A Oscilloscope Probe with Probe Master 5125BA BNC adapter, modified with wires for Probe Ground for ripple measurement. Two parallel decoupling capacitors have been added (1.0 μF , 50 V aluminum electrolytic and a 0.1 μF , 50 V ceramic)

9.2 DC Output Load Transient Response

Worst case transient measurements were obtained with a Kikusui electronic load and a Yokogawa DL1540L oscilloscope (20 MHz bandwidth) during output load steps at 265 V_{AC}. The transient response exhibits negligible overshoot.

9.2.1 10% to 50% load change, 265 V_{AC}

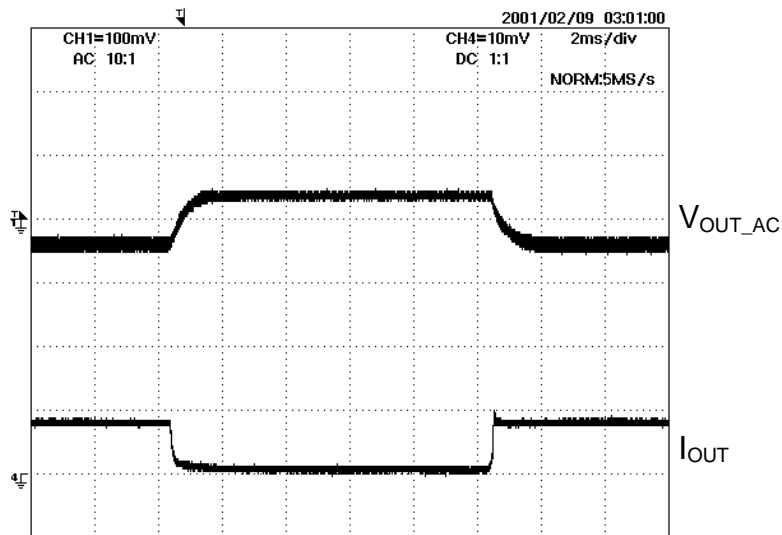

Figure 16. Transient Response 265 V_{AC} 50 Hz, I_{OUT}: 0.03 A to 0.17 A
V_{OUT} & I_{OUT} (100 mV & 200 mA/div, 2 ms/div)

9.2.2 10% to 100% load change, 265 V_{AC}



Figure 17. Transient Response 265 V_{AC} 50 Hz, I_{OUT}: 0.03 A to 0.33 A
V_{OUT} & I_{OUT} (100 mV & 200 mA/div, 2 ms/div)



9.3 Turn-On Delay and Overshoot

Turn-on delay was recorded as referenced to the DRAIN-SOURCE voltage. A resistive load is recommended to avoid incorrect results when using electronic loads.

In all cases, overshoot is negligible and turn-on delay is less than 8 ms, worst-case.

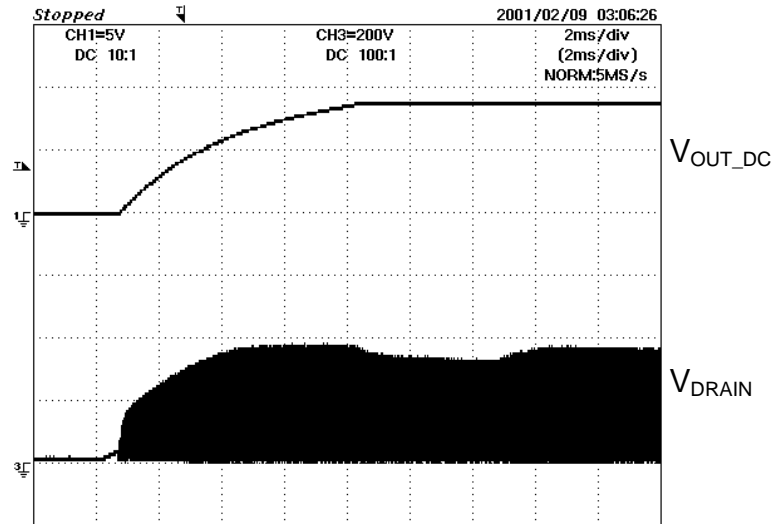

Figure 18. Start-up, 0.33 A Load, 85 V_{AC}
 V_{OUT} & V_{DRAIN} (5 & 200 V/div, 2ms/div)

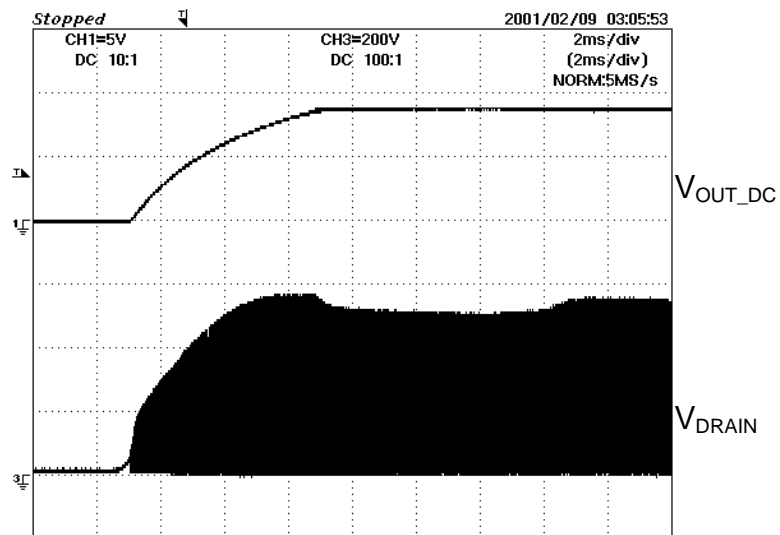

Figure 19. Start-up, 0.33 A Load, 265 V_{AC}
 V_{OUT} & V_{DRAIN} (5 & 200 V/div, 2ms/div)



9.4 Drain Switching Waveforms

The following waveforms detail DRAIN-SOURCE voltage and current at full load while varying the AC input. The operating mode of the TNY264 can vary under identical operating conditions. The waveforms display both the high and low switching frequencies possible under identical operating conditions. Actual operating mode depends on magnetizing inductance (LP), current limit (ILIM), together with line voltage and load.

9.4.1 85 V_{AC}, Full load, 132 kHz operation

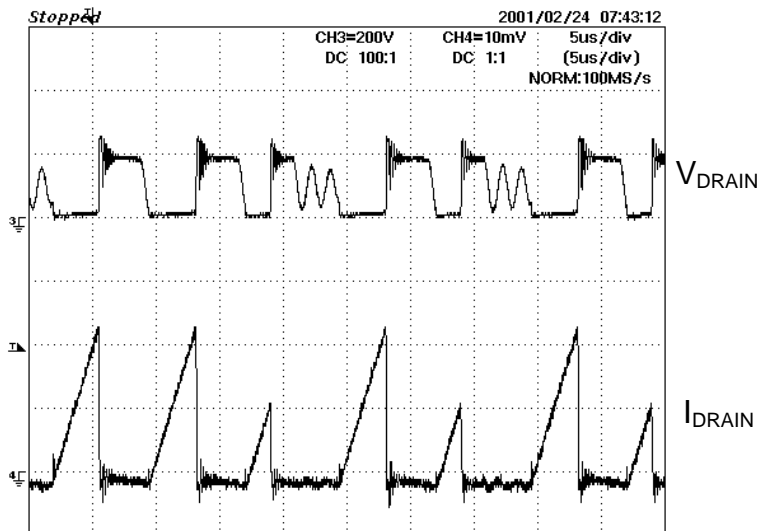

Figure 20. V_{DRAIN} & I_{DRAIN} (200 V & 0.1 A/div) at 3 W Load, 85 V_{AC} Input. (5 µs/div)

9.4.2 85 V_{AC}, Full load, ~100 kHz operation

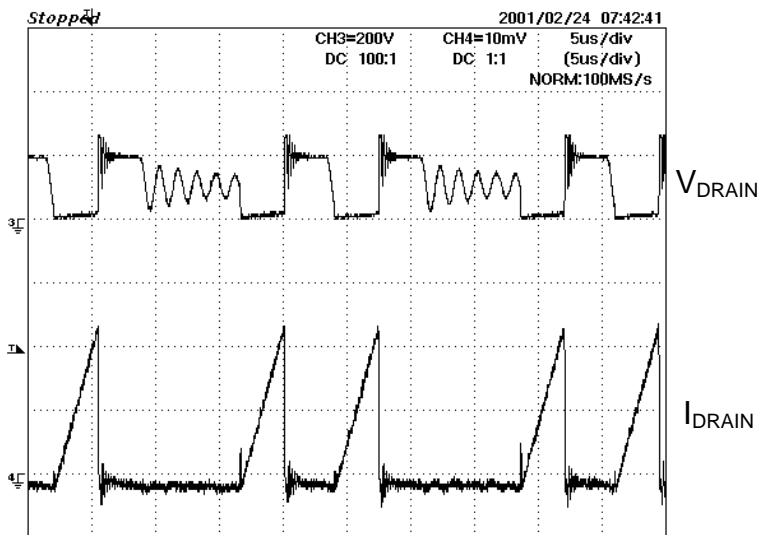

Figure 21. V_{DRAIN} & I_{DRAIN} (200 V & 0.1 A/div) at 3 W Load, 85 V_{AC} Input. (5 µs/div)



9.4.3 265 V_{AC}, Full load, 132 kHz operation

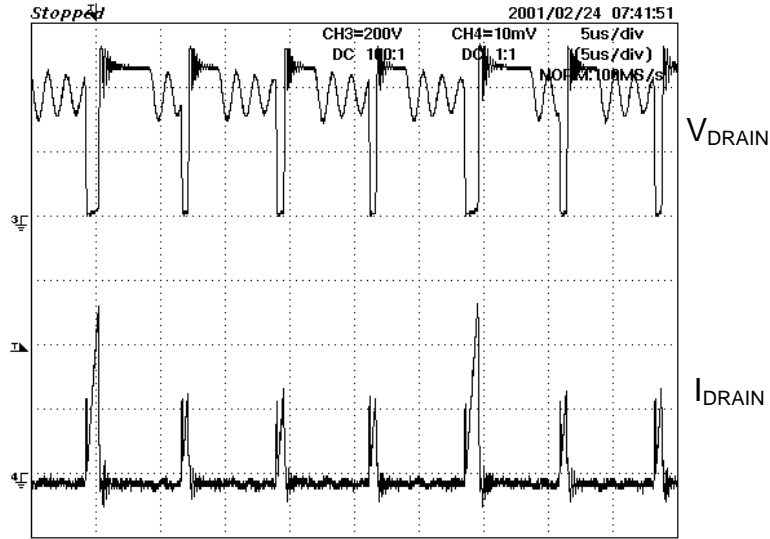

Figure 22. V_{DRAIN} & I_{DRAIN} (200 V & 0.1 A/div) at 3 W Load, 265 V_{AC} Input. (5 μs/div)

9.4.4 265 V_{AC}, Full load, ~60 kHz operation

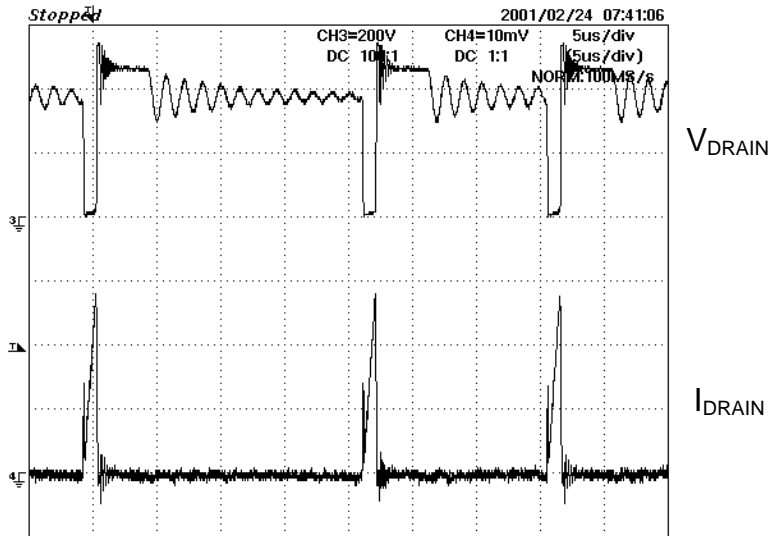

Figure 23. V_{DRAIN} & I_{DRAIN} (200 V & 0.1 A/div) at 3 W Load, 265 V_{AC} Input. (5 μs/div)



10 AC Surge and 100 kHz Ring Wave Immunity

Running at full load (resistive 3 W), 115 and 230 V_{AC}, 60 Hz. the power supply was subjected to repeated high voltage AC Surge (IEC 1000-4-5) and Ring Wave tests (IEEE C62.41). These included both common mode and differential mode injection. A Keytek EMCPro was utilized with a 2 Ω/12 Ω source impedance (as indicated).

In typical adapter applications immunity to 1 kV (IEC 1000-4-5, class 2) would be required. From the results below it can be seen that this is exceeded.

To monitor power supply status, LED were connected across the DC output. Evaluation was completed with reference to the following:

<u>Pass</u>	Normal performance within specification limits
<u>Blink</u>	Temporary degradation (PSU glitches - LED blink)
<u>Latch-up</u>	Temporary degradation with operator intervention (PSU stops - LED turns off, but returns with AC cycle)
<u>Fail</u>	Permanent, unrecoverable degradation (power supply and/or component damage)

Conditions were a single sample (UUT4) with tests performed in the order indicated. Corrective action between test failures were as indicated. The environmental conditions were a room ambient of 23 °C with ~70 % humidity, a repetition rate 1of 5 s, an internal trigger and 90° phase injection.

10.1 Differential Mode Surge Test Results

The results for differential mode surge immunity testing are shown below (IEC 1000-4-5, 1.2/50 μs - 8/20 μs, L-N). For differential mode tests, a two-wire AC cord was utilized. AC Ground (PE) was disconnected. There was a 2 Ω generator source impedance.

Compliance beyond Class 3 (1 kV), with no degradation, was confirmed.

Iteration Voltage (VAC)	1 115/230	2 115/230	3 115/230	4 115/230	5 115/230	Test Sequence
+500	Pass/Pass	Pass/Pass	Pass/Pass	Pass/Pass	Pass/Pass	1
-500	Pass/Pass	Pass/Pass	Pass/Pass	Pass/Pass	Pass/Pass	2
+1000	Pass/Pass	Pass/Pass	Pass/Pass	Pass/Pass	Pass/Pass	3
-1000	Pass/Pass	Pass/Pass	Pass/Pass	Pass/Pass	Pass/Pass	4
+1500	Pass/Pass	Pass/Pass	Pass/Pass	Pass/Pass	Pass/Pass	5
-1500	Pass/Pass	Pass/Pass	Pass/Pass	Pass/Pass	Pass/Pass	6
+2000	Pass/Pass	Pass/Pass	Pass/Pass	Pass/Pass	Pass/ Fail	7
-2000	n/a	n/a	n/a	n/a	n/a	8

Table 3. Differential Mode Surge Test Results

Differential Surge failure at +2 kV required replacement of input fusible resistor (R1), TNY264P (U1) and transformer (T1). Testing was completed on UUT4.



10.2 Common Mode Surge Test Results

The results for common mode surge immunity testing are shown below (IEC 1000-4-5, 1.2/50 μ s - 8/20 μ s, L/N-G). For common mode tests, a three-wire AC cord was utilized. AC Ground (PE) was tied from AC outlet to power supply output RTN through a copper strap. There was a 2 Ω generator source impedance.

Compliance beyond Class 3 (2 kV), with no degradation, was confirmed.

Iteration Voltage (VAC)	1 115/230	2 115/230	3 115/230	4 115/230	5 115/230	Test Sequence
+500	Pass/Pass	Pass/Pass	Pass/Pass	Pass/Pass	Pass/Pass	1
-500	Pass/Pass	Pass/Pass	Pass/Pass	Pass/Pass	Pass/Pass	2
+1000	Pass/Pass	Pass/Pass	Pass/Pass	Pass/Pass	Pass/Pass	3
-1000	Pass/Pass	Pass/Pass	Pass/Pass	Pass/Pass	Pass/Pass	4
+1500	Pass/Pass	Pass/Pass	Pass/Pass	Pass/Pass	Pass/Pass	5
-1500	Pass/Pass	Pass/Pass	Pass/Pass	Pass/Pass	Pass/Pass	6
+2000	Pass/Pass	Pass/Pass	Pass/Pass	Pass/Pass	Pass/Pass	7
+2000	Pass/Pass	Pass/Pass	Pass/Pass	Pass/Pass	Pass/Pass	8
+3000	Pass/Pass	Pass/Pass	Pass/Pass	Pass/Pass	Pass/Pass	9
-3000	Pass/Pass	Pass/Pass	Pass/Pass	Pass/Pass	Pass/Pass	10

Table 4. Common Mode Surge Testing Results

Y-capacitor verified prior to proceeding with immunity testing.

10.3 Differential Mode 100 kHz Ring Wave Test Results

The results for differential mode 100 kHz Ring Wave immunity testing are shown below (IEEE C62.41, L-N). For differential mode tests, a two-wire AC cord was utilized. AC Ground (PE) was disconnected. There was a 12 Ω generator source impedance.

Compliance to 3 kV, with no degradation, was confirmed.

Iteration Voltage (VAC)	1 115/230	2 115/230	3 115/230	4 115/230	5 115/230	Test Sequence
+500	Pass/Pass	Pass/Pass	Pass/Pass	Pass/Pass	Pass/Pass	1
-500	Pass/Pass	Pass/Pass	Pass/Pass	Pass/Pass	Pass/Pass	2
+1000	Pass/Pass	Pass/Pass	Pass/Pass	Pass/Pass	Pass/Pass	3
-1000	Pass/Pass	Pass/Pass	Pass/Pass	Pass/Pass	Pass/Pass	4
+1500	Pass/Pass	Pass/Pass	Pass/Pass	Pass/Pass	Pass/Pass	5
-1500	Pass/Pass	Pass/Pass	Pass/Pass	Pass/Pass	Pass/Pass	6
+2000	Pass/Pass	Pass/Pass	Pass/Pass	Pass/Pass	Pass/Pass	7
+2000	Pass/Pass	Pass/Pass	Pass/Pass	Pass/Pass	Pass/Pass	8
+3000	Pass/Pass	Pass/Pass	Pass/Pass	Pass/Pass	Pass/Pass	9
-3000	Pass/Pass	Pass/Pass	Pass/Pass	Pass/Pass	Pass/Pass	10

Table 5. Differential Mode 100 kHz Ring Wave Test Results



10.4 Common Mode 100kHz Ring Wave Test Results

The results for common mode 100 kHz Ring Wave immunity testing are shown below (IEEE C62.41, L/N-PE). For common mode tests, a two wire AC cord was utilized. AC Ground (PE) was tied from AC outlet to power supply RTN through a copper strap. There was a 12 Ω generator source impedance.

Compliance to 3 kV, with no degradation, was confirmed.

Iteration Voltage (VAC)	1 115/230	2 115/230	3 115/230	4 115/230	5 115/230	Test Sequence
+500	Pass/Pass	Pass/Pass	Pass/Pass	Pass/Pass	Pass/Pass	1
-500	Pass/Pass	Pass/Pass	Pass/Pass	Pass/Pass	Pass/Pass	2
+1000	Pass/Pass	Pass/Pass	Pass/Pass	Pass/Pass	Pass/Pass	3
-1000	Pass/Pass	Pass/Pass	Pass/Pass	Pass/Pass	Pass/Pass	4
+1500	Pass/Pass	Pass/Pass	Pass/Pass	Pass/Pass	Pass/Pass	5
-1500	Pass/Pass	Pass/Pass	Pass/Pass	Pass/Pass	Pass/Pass	6
+2000	Pass/Pass	Pass/Pass	Pass/Pass	Pass/Pass	Pass/Pass	7
+2000	Pass/Pass	Pass/Pass	Pass/Pass	Pass/Pass	Pass/Pass	8
+3000	Pass/Pass	Pass/Pass	Pass/Pass	Pass/Pass	Pass/Pass	9
-3000	Pass/Pass	Pass/Pass	Pass/Pass	Pass/Pass	Pass/Pass	10

Table 6. Common Mode 100 kHz Ring Wave Test Results



11 Revision History

Date	Author	Revision	Description & changes
09-Feb-2001	SH	0.1	Original draft
21-Feb-2001	SH	0.2	Update new transformer results
26-Feb-2001	SH	0.3	Format changes, rev thermal results
15-Mar-2001	SH	1.0	Format changes
20-Mar-2001	PV	1.1	Format changes – audio noise set photo added
02-Apr-2001	PV	1.2	Spelling and formatting errors corrected
22-Feb-2002	PV	1.3	p.6 – reference to D6 corrected to read D5 in fourth paragraph



For the latest updates, visit our website: www.powerint.com

Power Integrations reserves the right to make changes to its products at any time to improve reliability or manufacturability. Power Integrations does not assume any liability arising from the use of any device or circuit described herein, nor does it convey any license under its patent rights or the rights of others.

PI Logo, *TOPSwitch* and *TinySwitch* are registered trademarks of Power Integrations, Inc.
©Copyright 2001, Power Integrations, Inc.

WORLD HEADQUARTERS

NORTH AMERICA - WEST

Power Integrations, Inc.
5245 Hellyer Avenue
San Jose, CA 95138 USA.
Main: +1•408•414•9200
Customer Service:
Phone: +1•408•414•9665
Fax: +1•408•414•9765

**NORTH AMERICA - EAST
& SOUTH AMERICA**

Power Integrations, Inc.
Eastern Area Sales Office
1343 Canton Road, Suite C1
Marietta, GA 30066 USA
Phone: +1•770•424•5152
Fax: +1•770•424•6567

EUROPE & AFRICA

Power Integrations (Europe)
Ltd.
Centennial Court
Easthampstead Road
Bracknell
Berkshire RG12 1YQ,
United Kingdom
Phone: +44•1344•462•300
Fax: +44•1344•311•732

TAIWAN

Power Integrations International
Holdings, Inc.
2F, #508, Chung Hsiao E. Rd.,
Sec. 5,
Taipei 105, Taiwan
Phone: +886•2•2727•1221
Fax: +886•2•2727•1223

CHINA

Power Integrations, China
Rm# 1705, Bao Hua Bldg.
1016 Hua Qiang Bei Lu
Shenzhen Guangdong, 518031
Phone: +86•755•377•9485
Fax: +86•755•377•9610

KOREA

Power Integrations International
Holdings, Inc.
Rm# 402, Handuk Building,
649-4 Yeoksam-Dong,
Kangnam-Gu,
Seoul, Korea
Phone: +82•2•568•7520
Fax: +82•2•568•7474

JAPAN

Power Integrations, K.K.
Keihin-Tatemono 1st Bldg.
12-20 Shin-Yokohama 2-
Chome,
Kohoku-ku, Yokohama-shi,
Kanagawa 222, Japan
Phone: +81•45•471•1021
Fax: +81•45•471•371

INDIA (Technical Support)

Innovatech
#1, 8th Main Road
Vasanthnagar
Bangalore 560052, India
Phone: +91•80•226•6023
Fax: +91•80•228•9727

APPLICATIONS HOTLINE

World Wide +1•408•414•9660

APPLICATIONS FAX

World Wide +1•408•414•9760



Power Integrations, Inc.

Tel: +1 408 414 9200 Fax: +1 408 414 9201
www.powerint.com