

1 Hz to 400 kHz\*  
Low Noise Fixed Frequency

**6 - Pole Single Power Supply  
Anti-Aliasing Low-Pass Filters**

**Description:**

The D96 Series of small 6-pole fixed-frequency, precision active filters provide high performance linear active filtering in a compact package, with a broad range of corner frequencies and a choice of Butterworth or Bessel transfer functions. These filters are designed to work with up to 16 Bit A/D converters. These fully self-contained units require no external components or adjustments.

Each model comes factory tuned to a user-specified corner frequency between 1 Hz and 400 kHz\* and operate with low total harmonic distortion over a wide dynamic input voltage range from non-critical single +5VDC to +18VDC power supply. Each filter has a built in internal +6VDC and -6VDC power supplies to power the filter.

**Features/Benefits:**

- Low harmonic distortion and wide signal-to-noise ratio to 16 bit resolution.
- Available with Single or Differential inputs.
- Available with DC coupled or AC coupled inputs. (The AC corner frequency is a single pole at 2 Hz.)
- Compact 1.5"L x 2.0"W x 0.4"H minimizes board space requirements.
- Plug-in ready-to-use, reducing engineering design and manufacturing cycle time.
- Factory tuned, no external clocks or adjustments needed.
- Available in Butterworth or Bessel transfer functions to meet a wide range of applications.
- Requires a single +5V to +18V power supply to operate (The module generates  $\pm 6$  VDC internally to operate the filter).
- One to one offset input that works with your A/Ds reference output to set the output of the filter in the center of your A/Ds input range.
- Available with built in gains from 0 dB to 60 dB.

\* Bessel 1 Hz to 200 Khz

**Applications**

- Anti-alias filtering
- Data acquisition systems
- Communication systems and electronics
- Medical electronics equipment and research
- Aerospace, navigation and sonar applications
- Sound and vibration testing
- Acoustic and vibration analysis and control
- Noise elimination
- Signal reconstruction



**Available Low-Pass Models:**

- |               |                    |
|---------------|--------------------|
| <b>D96L6B</b> | 6-Pole Butterworth |
| <b>D96L6L</b> | 6-Pole Bessel      |



1 Hz to 400 kHz\*  
Low Noise Fixed Frequency

6 - Pole Single Power Supply  
Anti-Aliasing Low-Pass Filters

|  | D96L6B   | D96L6L   |
|--|--|--|
| <b>Transfer Function</b>                           | 6-Pole Butterworth   | 6-Pole Bessel  |
| <b>Size</b>  | 1.5" x 2.0" x 0.4"   | 1.5" x 2.0" x 0.4"   |
| <b>Range <math>f_c</math></b>                      | 1.0 Hz to 400 kHz  | 1.0 Hz to 200 kHz  |
| <b>Theoretical Transfer Characteristics</b>        | Appendix A<br>Page 8   | Appendix A<br>Page 3   |
| <b>Passband Ripple<br/>(theoretical)</b>           | 0.0 dB   | 0.0 dB   |
| <b>DC Voltage Gain<br/>(non-inverting)</b>         | 0 ± 0.1 dB max.<br>0 ± 0.05 dB typ.  | 0 ± 0.1 dB max.<br>0 ± 0.05 dB typ.  |
| <b>Stopband<br/>Attenuation Rate</b>               | 36 dB/octave   | 30 dB/octave   |
| <b>Cutoff Frequency<br/>Stability</b>              | $f_c$ ± 1% max.<br>± 0.01%/°C  | $f_c$ ± 1% max.<br>± 0.01%/°C  |
| <b>Amplitude<br/>Phase</b>                         | -3 dB<br>-270°   | -3 dB<br>-155°   |
| <b>Filter Attenuation<br/>(theoretical)</b>        | 0.29 dB 0.80 $f_c$<br>3.01 dB 1.00 $f_c$<br>60.0 dB 3.16 $f_c$<br>80.0 dB 4.64 $f_c$ | 1.99 dB 0.80 $f_c$<br>3.01 dB 1.00 $f_c$<br>60.0 dB 5.42 $f_c$<br>80.0 dB 7.99 $f_c$ |
| <b>Amplitude Accuracy<br/>(theoretical)</b>        | 0 – 0.8 $f_c$<br>±0.2 dB max.<br>±0.1 dB typ.  | 0 – 0.8 $f_c$<br>±0.2 dB max.<br>±0.1 dB typ.  |
|  | 0.8 $f_c$ – 1.0 $f_c$<br>±0.3 dB max.<br>±0.15 dB typ.                               | 0.8 $f_c$ – 1.0 $f_c$<br>±0.3 dB max.<br>±0.15 dB typ.                               |
| <b>(THD) Total Harmonic<br/>Distortion @ 1 kHz</b> | <-100 dB   | <-100 dB   |
| <b>Wide Band Noise<br/>(5 Hz – 2 MHz)</b>          | < 200 $\mu$ Vrms   | < 200 $\mu$ Vrms   |
| <b>SINAD</b>                                       | <-100 dB   | <-100 dB   |

**Specifications**  
 (25°C and  $V_s + 5$  VDC to + 18 VDC)

**Pin-Out and Package Data**  
**Ordering Information**
**Analog Input Characteristics<sup>1</sup>**

|                   |                |
|-------------------|----------------|
| Impedance         | 1 M $\Omega$   |
| Voltage Range     | $\pm 6$ V peak |
| Max. Safe Voltage | $\pm 6$ V      |

**Analog Output Characteristics**

|                                     |                                   |
|-------------------------------------|-----------------------------------|
| Impedance<br>(Closed Loop)          | 1 $\Omega$ typ., 10 $\Omega$ max. |
| Linear Operating Range <sup>3</sup> | $\pm 5$ V                         |
| Maximum Current <sup>2</sup>        | $\pm 5$ mA                        |
| Offset Voltage <sup>3</sup>         | $\pm 5$ VDC                       |

**Power Supply ( $\pm V$ )**

|                   |                     |
|-------------------|---------------------|
| Rated Voltage     | + 5 VDC to + 18 VDC |
| Quiescent Current | ~110 mA             |

**Temperature Range**

|           |                |
|-----------|----------------|
| Operating | 0°C to +70°C   |
| Storage   | -25°C to +85°C |

## Notes:

1. Input and output signal voltage referenced to supply common.
2. Output is short circuit protected to common. DO NOT CONNECT TO  $\pm V_s$ .
3. Any voltage applied to the offset pin appears at the output and an output offset. Note that if, for instance, the offset pin is at 2 VDC the maximum linear operating range will be  $\pm 3$  V not  $\pm 5$  V. This is because you cannot exceed +5V or -5V linear operating range. Any voltage applied to the Offset Pin is low pass filtered to remove noise.
4. Units operate with or without offset pin connected.
5. How to specify Corner Frequency. Corner frequency is specified by attaching a three-digit frequency designator to the basic model number. Corner frequencies can range from 1.00 Hz to 400 kHz.

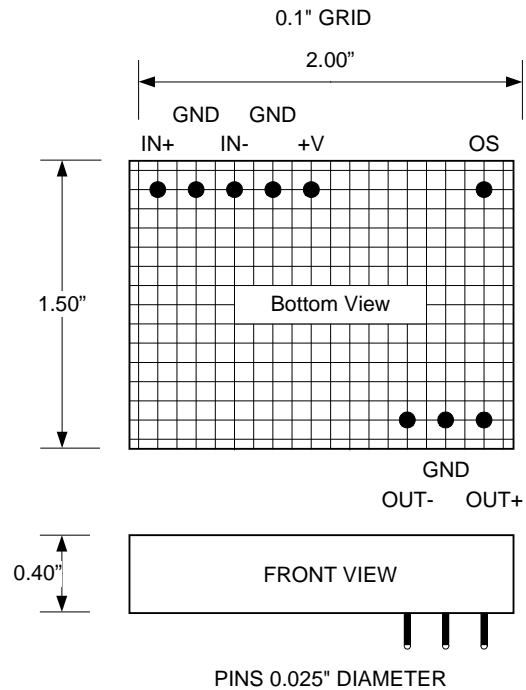
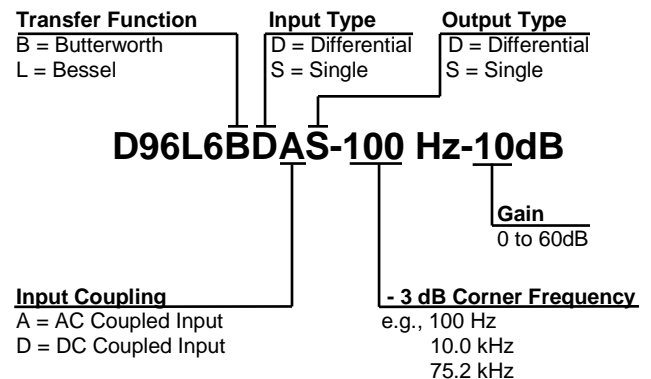
**Pin-Out and Package Data**

**ORDERING INFORMATION**



**Appendix A**

**Theoretical Transfer Characteristics**

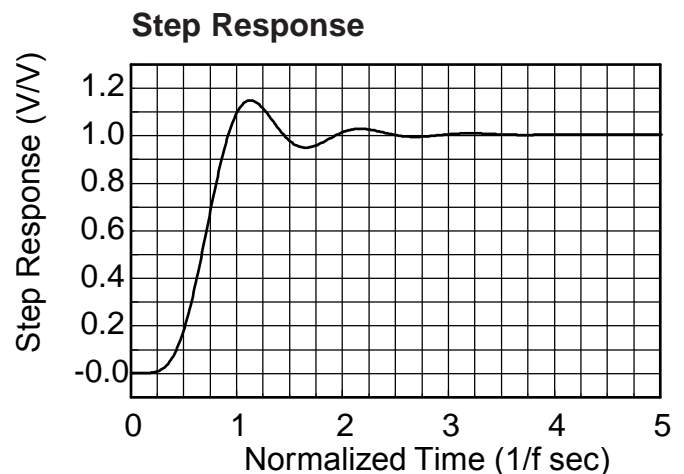
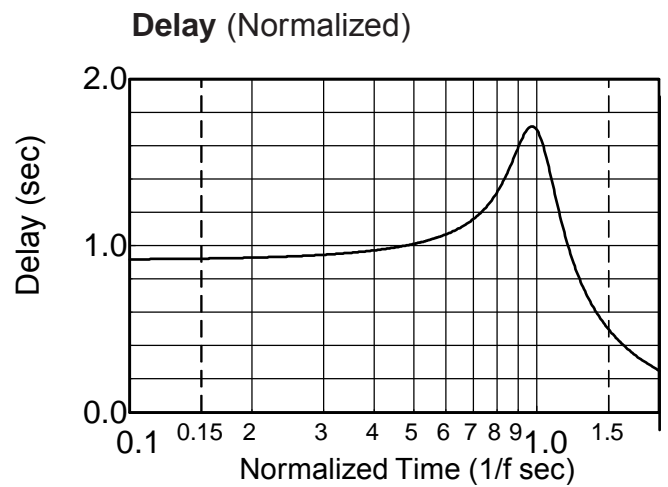
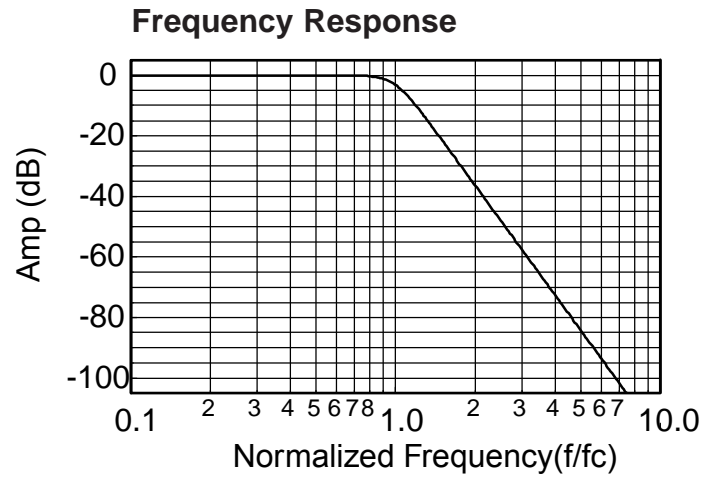
| f/fc<br>(Hz) | Amp<br>(dB) | Phase<br>(deg) | Delay <sup>1</sup><br>(sec) |
|--------------|-------------|----------------|-----------------------------|
| 0.00         | 0.00        | 0.00           | .615                        |
| 0.10         | 0.00        | -22.2          | .617                        |
| 0.20         | 0.00        | -44.5          | .624                        |
| 0.30         | 0.00        | -67.2          | .637                        |
| 0.40         | 0.00        | -90.4          | .656                        |
| 0.50         | -0.001      | -115           | .685                        |
| 0.60         | -0.009      | -140           | .731                        |
| 0.70         | -0.060      | -167           | .803                        |
| 0.80         | -0.289      | -198           | .911                        |
| 0.85         | -0.578      | -215           | .970                        |
| 0.90         | -1.080      | -233           | 1.02                        |
| 0.95         | -1.88       | -252           | 1.03                        |
| 1.00         | -3.01       | -270           | 1.00                        |
| 1.10         | -6.17       | -304           | .845                        |
| 1.20         | -9.96       | -331           | .660                        |
| 1.30         | -13.9       | -352           | .518                        |
| 1.40         | -17.6       | -368           | .417                        |
| 1.50         | -21.2       | -382           | .345                        |
| 1.60         | -24.5       | -393           | .291                        |
| 1.70         | -27.7       | -403           | .251                        |
| 1.80         | -30.6       | -412           | .219                        |
| 1.90         | -33.5       | -419           | .193                        |
| 2.00         | -36.1       | -425           | .171                        |
| 2.25         | -42.3       | -439           | .132                        |
| 2.50         | -47.8       | -450           | .105                        |
| 2.75         | -52.7       | -458           | .086                        |
| 3.00         | -57.3       | -465           | .071                        |
| 3.25         | -61.4       | -471           | .060                        |
| 3.50         | -65.3       | -476           | .052                        |
| 4.00         | -72.2       | -484           | .039                        |
| 5.00         | -83.9       | -496           | .025                        |
| 6.00         | -93.4       | -503           | .017                        |
| 7.00         | -101        | -508           | .012                        |
| 8.00         | -108        | -512           | .0097                       |
| 9.00         | -115        | -515           | .0076                       |
| 10.0         | -120        | -518           | .0062                       |



**1. Normalized Group Delay:**

The above delay data is normalized to a corner frequency of 1.0Hz. The actual delay is the normalized delay divided by the actual corner frequency (fc).

$$\text{Actual Delay} = \frac{\text{Normalized Delay}}{\text{Actual Corner Frequency (fc) in Hz}}$$



**Appendix A**

**Theoretical Transfer Characteristics**

| f/fc<br>(Hz) | Amp<br>(dB) | Phase<br>(deg) | Delay <sup>1</sup><br>(sec) |
|--------------|-------------|----------------|-----------------------------|
| 0.00         | 0.00        | 0.00           | .430                        |
| 0.10         | -0.029      | -15.5          | .430                        |
| 0.20         | -0.116      | -31.0          | .430                        |
| 0.30         | -0.261      | -46.5          | .430                        |
| 0.40         | -0.465      | -62.0          | .430                        |
| 0.50         | -0.728      | -77.4          | .430                        |
| 0.60         | -1.05       | -92.9          | .430                        |
| 0.70         | -1.44       | -108           | .430                        |
| 0.80         | -1.89       | -124           | .430                        |
| 0.85         | -2.15       | -132           | .430                        |
| 0.90         | -2.42       | -139           | .430                        |
| 0.95         | -2.70       | -147           | .430                        |
| 1.00         | -3.01       | -155           | .430                        |
| 1.10         | -3.68       | -170           | .429                        |
| 1.20         | -4.44       | -186           | .428                        |
| 1.30         | -5.29       | -201           | .426                        |
| 1.40         | -6.23       | -216           | .422                        |
| 1.50         | -7.29       | -232           | .416                        |
| 1.60         | -8.46       | -246           | .401                        |
| 1.70         | -9.74       | -261           | .393                        |
| 1.80         | -11.1       | -275           | .376                        |
| 1.90         | -12.6       | -287           | .357                        |
| 2.00         | -14.2       | -300           | .335                        |
| 2.25         | -18.3       | -328           | .279                        |
| 2.50         | -22.6       | -351           | .228                        |
| 2.75         | -26.7       | -369           | .187                        |
| 3.00         | -30.7       | -385           | .156                        |
| 3.25         | -34.5       | -398           | .131                        |
| 3.50         | -38.1       | -408           | .111                        |
| 4.00         | -44.7       | -426           | .083                        |
| 5.00         | -55.9       | -449           | .052                        |
| 6.00         | -65.2       | -465           | .036                        |
| 7.00         | -73.2       | -476           | .026                        |
| 8.00         | -80.1       | -484           | .020                        |
| 9.00         | -86.2       | -490           | .015                        |
| 10.0         | -91.6       | -495           | .013                        |

**Frequency Response**

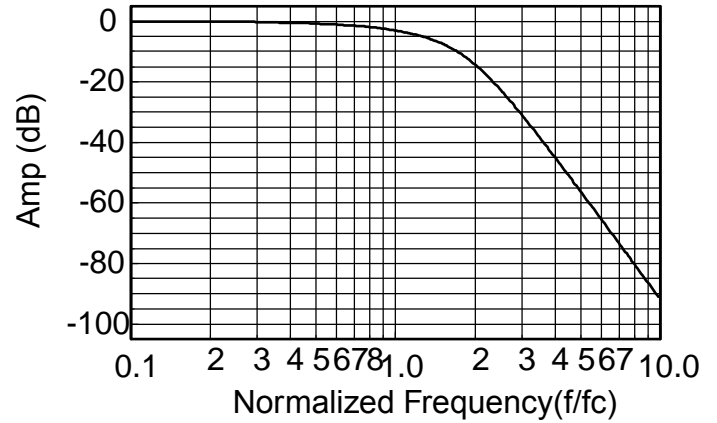

**Delay (Normalized)**

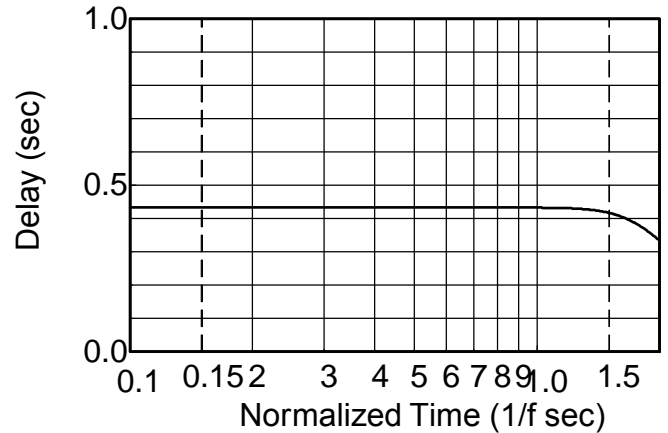

**Step Response**

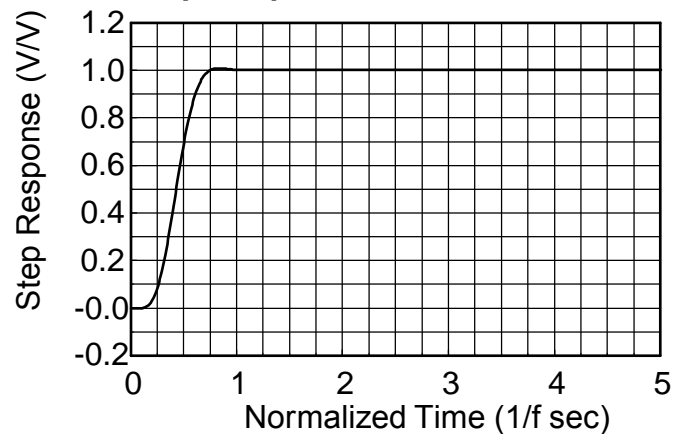

**1. Normalized Group Delay:**

The above delay data is normalized to a corner frequency of 1.0Hz. The actual delay is the normalized delay divided by the actual corner frequency (fc).

$$\text{Actual Delay} = \frac{\text{Normalized Delay}}{\text{Actual Corner Frequency (fc) in Hz}}$$