

## Descriptions

The S1117 series of positive adjustable and fixed regulators are designed to provide 1A with high efficiency. All internal circuitry is designed to operate down to 1.3V input to output differential. On-chip trimming adjusts reference voltage to 2%.

## Features

- Adjustable or fixed output
- Output current of 1A
- Low dropout, 1.3V maximum at 1A output current
- Thermal shutdown protection

## Ordering Information

Type NO.	Marking	Package Code
S1117AQ/S1117xxQ	S1117□□Q / S1117□□□Q	SOT-223
□□: Voltage Code (Aj : 1.25V, 15:1.5V;18: 1.8V, 25:2.5V, 33:3.3V, 50:5.0V) □□□: Voltage Code (285:2.85V)		

## Outline Dimensions (Unit : mm)

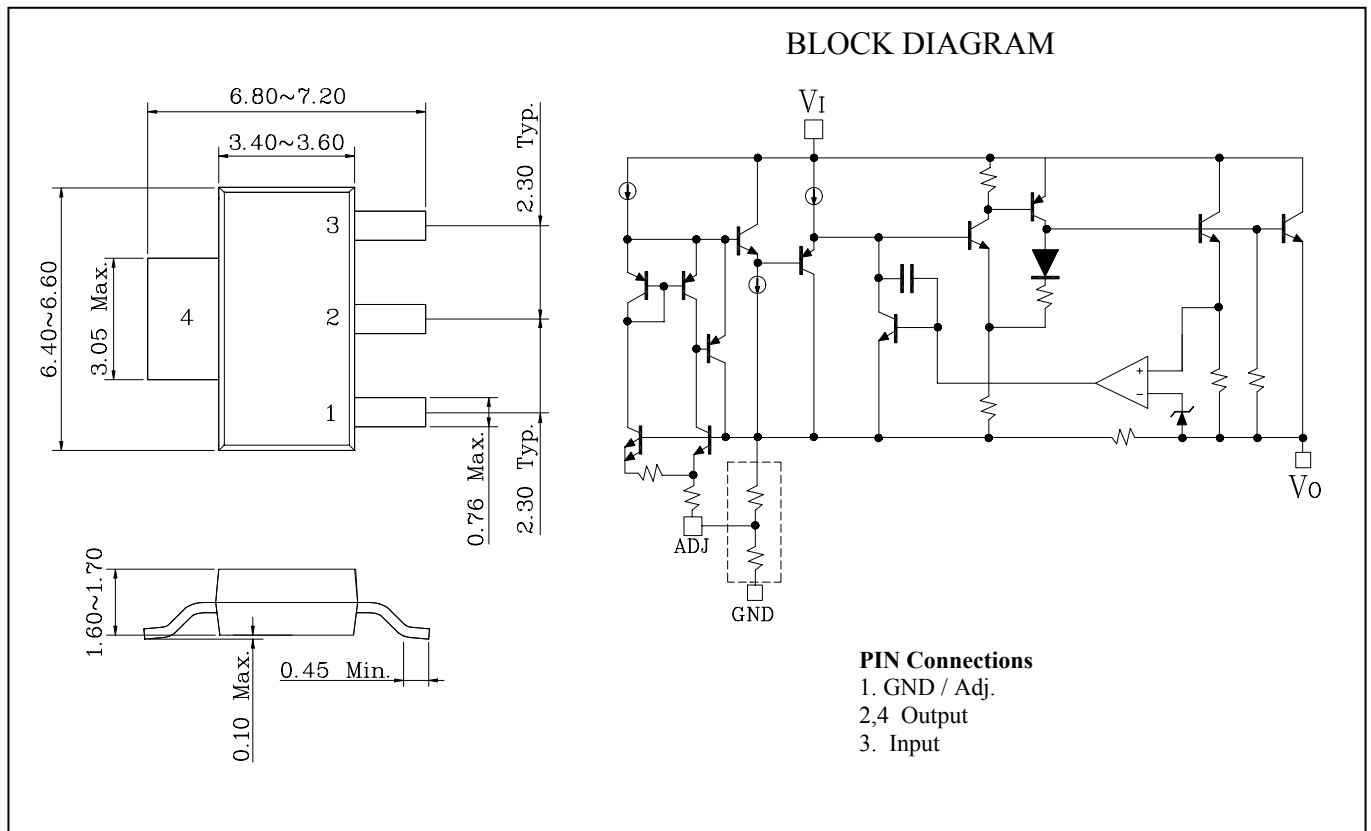

## Absolute Maximum Ratings

[Ta=25°C]

Characteristic	Symbol	Rating	Unit
Input voltage	$V_I$	16	V
Power Dissipation	$P_{D1}$ (Note1)	2.8	W
	$P_{D2}$ (Note2)	0.8	
Junction Temperature	$T_J$	150	°C
Operating temperature range	$T_{opr}$	0 ~ +125	°C
Storage temperature range	$T_{stg}$	-55 ~ +150	°C

Note 1 : Mounted on a glass epoxy circuit board of 25.4 × 25.4mm. (at 1oz copper area)

Note 2 : No Heat sink

## Recommended operating conditions

Characteristic	Symbol	Min.	Max.	Unit
Input voltage	$V_I$	$V_O+1.5V$	$V_O+7V$	V
Output current	$I_O$	1	1000	mA

## Device Selection Guide

Device	Output Voltage
S1117AQ	Adjustable
S1117-15Q	1.50V
S1117-18Q	1.80V
S1117-25Q	2.50V
S1117-285Q	2.85V
S1117-33Q	3.30V
S1117-50Q	5.00V

Note 3 : Other fixed versions are available  $V_O=1.5V \sim 5V$

## Electrical Characteristics

(Electrical Characteristics at  $0^{\circ}\text{C} \leq T_a \leq 125^{\circ}\text{C}$  and  $V_I = (V_O + 1.5\text{V})$ ,  $I_O = 10\text{mA}$ ,  $C_O = 10\mu\text{F}$ , unless otherwise specified.)

Characteristic	Symbol	Device	Test Condition	Min	Typ	Max	Unit	
Output voltage	$V_O$	S1117A		*	1.23	1.28	V	
			$V_I = (V_O + 1.5\text{V})$ to 7V $I_O = 0$ to 1000mA		1.20	1.30		
		S1117-15		*	1.47	1.53	1.50	
			$V_I = (V_O + 1.5\text{V})$ to 7V $I_O = 0$ to 1000mA		1.44	1.56		
		S1117-18		*	1.76	1.84	1.80	
			$V_I = (V_O + 1.5\text{V})$ to 7V $I_O = 0$ to 1000mA		1.73	1.87		
		S1117-25		*	2.45	2.55	2.50	
			$V_I = (V_O + 1.5\text{V})$ to 7V $I_O = 0$ to 1000mA		2.40	2.60		
		S1117-285		*	2.79	2.91	2.85	
			$V_I = (V_O + 1.5\text{V})$ to 7V $I_O = 0$ to 1000mA		2.74	2.96		
		S1117-33		*	3.23	3.37	3.30	
			$V_I = (V_O + 1.5\text{V})$ to 7V $I_O = 0$ to 1000mA		3.17	3.43		
S1117-50		*	4.90	5.10	5.00			
	$V_I = (V_O + 1.5\text{V})$ to 7V $I_O = 0$ to 1000mA		4.80	5.20				
Line regulation (Note4)	$ \Delta V_{O(\Delta V_I)} $	All	$1.5\text{V} \leq V_I - V_O \leq 7\text{V}$ $I_O = 10\text{mA}$	*	-	5	10	mV
Load regulation (Note4)	$ \Delta V_{O(\Delta I_L)} $	All	$1.5\text{V} \leq V_I - V_O \leq 7\text{V}$ $I_O = 10\text{mA} \sim 1000\text{mA}$	*	-	10	30	mV
Quiescent current	$I_{QC}$	All	$I_O = 0$		-	7	13	mA
Minimum load current	$I_{L(\text{MIN})}$	S1117A	$V_{\text{Adj}} = 0\text{V}$			3	7	mA
Adjust pin current	$I_{\text{ADJ}}$	S1117A	$V_I = (V_O + 1.5\text{V})$ to 7V $I_O = 100\text{mA}$			55	90	$\mu\text{A}$
Adjust pin current change	$ \Delta I_{\text{ADJ}} $	S1117A	$1.5\text{V} \leq V_I - V_O \leq 7\text{V}$ $I_O = 10\text{mA} \sim 1000\text{mA}$			1	5	$\mu\text{A}$
Dropout voltage	$V_{\text{DROP}}$	All	$I_O = 1000\text{mA}$	*	-	1.2	1.3	V
Ripple rejection ratio	RR	All	$I_O = 1000\text{mA}$ $V_{\text{Ripple}} = 1\text{V}_{\text{P-P}}$ , $f = 120\text{Hz}$	*	60	72	-	dB
Current limit	$I_{\text{LIMIT}}$	All	$I_O \geq 1000\text{mA}$	*	1.1			A

[ \* ]  $T_a = 25^{\circ}\text{C}$

Note 4: Low duty pulse testing with Kelvin connections required.

## ■ Typical Applications

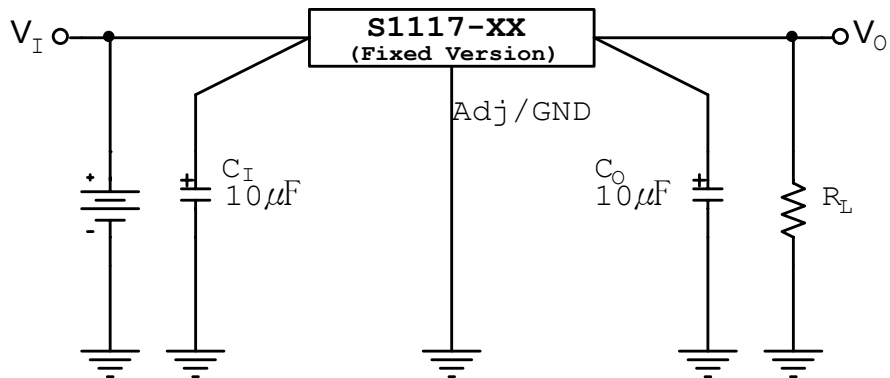
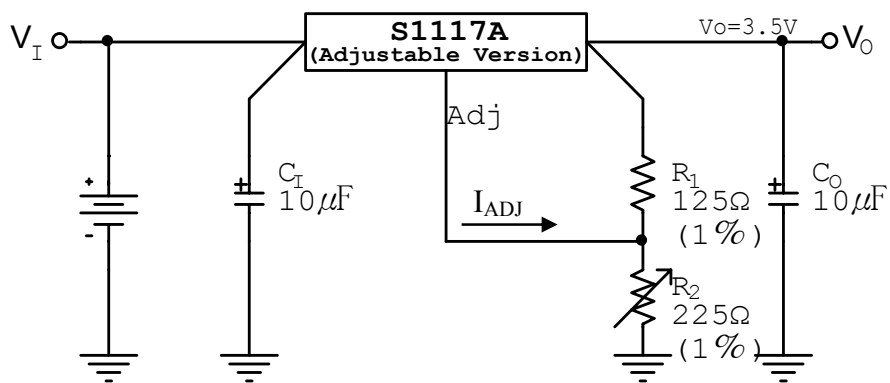

Fig. 1 Fixed Voltage Regulator



$$V_O = V_{ADJ} \times \left(1 + \frac{R_2}{R_1}\right) + I_{ADJ} \times R_2$$

Fig. 2 Adjustable Voltage Regulator

Notes 5:

- 1)  $C_I$  needed if device is far from filter capacitors
- 2)  $C_O$  minimum value required for stability

## Electrical Characteristic Curves

Fig.3  $V_{DROD}$  vs  $I_O$

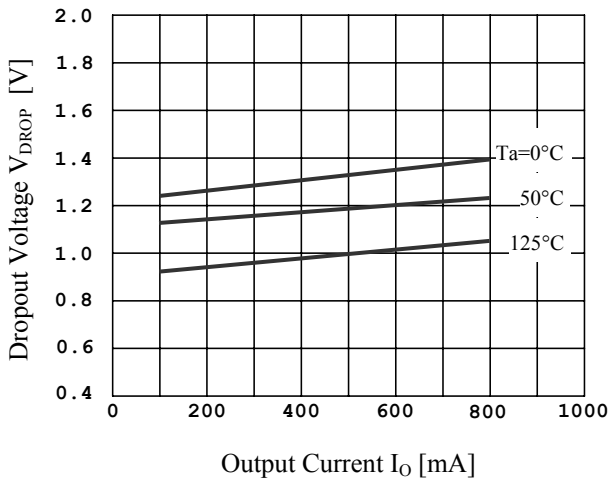

Fig.4  $V_O$  vs  $T_a$

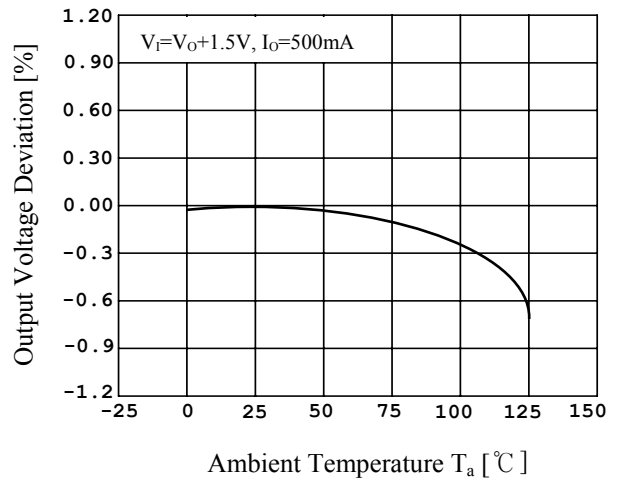

Fig.5  $I_{L(MIN)}$  vs  $V_I - V_O$

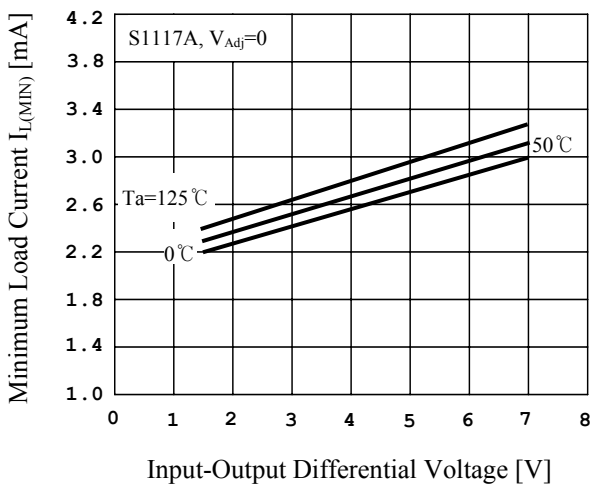

Fig.6  $I_{Adj}$  vs  $T_a$

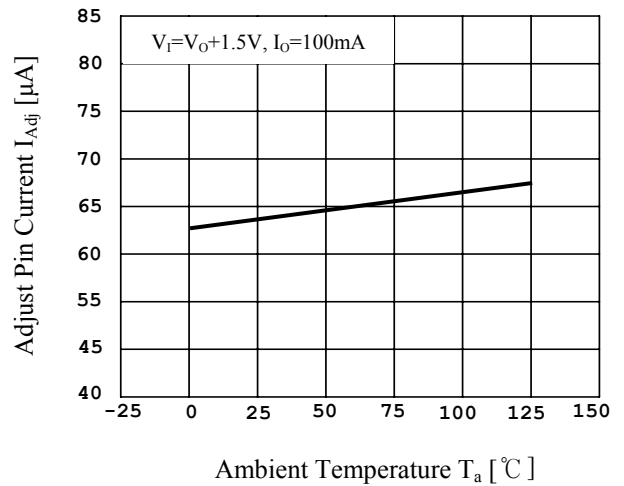
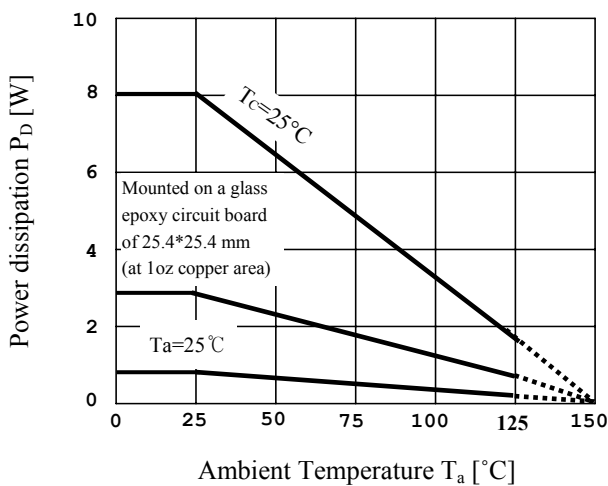

Fig.7  $P_D$  vs  $T_a$



**The AUK Corp. products are intended for the use as components in general electronic equipment (Office and communication equipment, measuring equipment, home appliance, etc.).**

**Please make sure that you consult with us before you use these AUK Corp. products in equipments which require high quality and / or reliability, and in equipments which could have major impact to the welfare of human life(atomic energy control, airplane, spaceship, transportation, combustion control, all types of safety device, etc.). AUK Corp. cannot accept liability to any damage which may occur in case these AUK Corp. products were used in the mentioned equipments without prior consultation with AUK Corp..**

**Specifications mentioned in this publication are subject to change without notice.**