

Single IGBTMOD™ U-Series Module 400 Amperes/1200 Volts

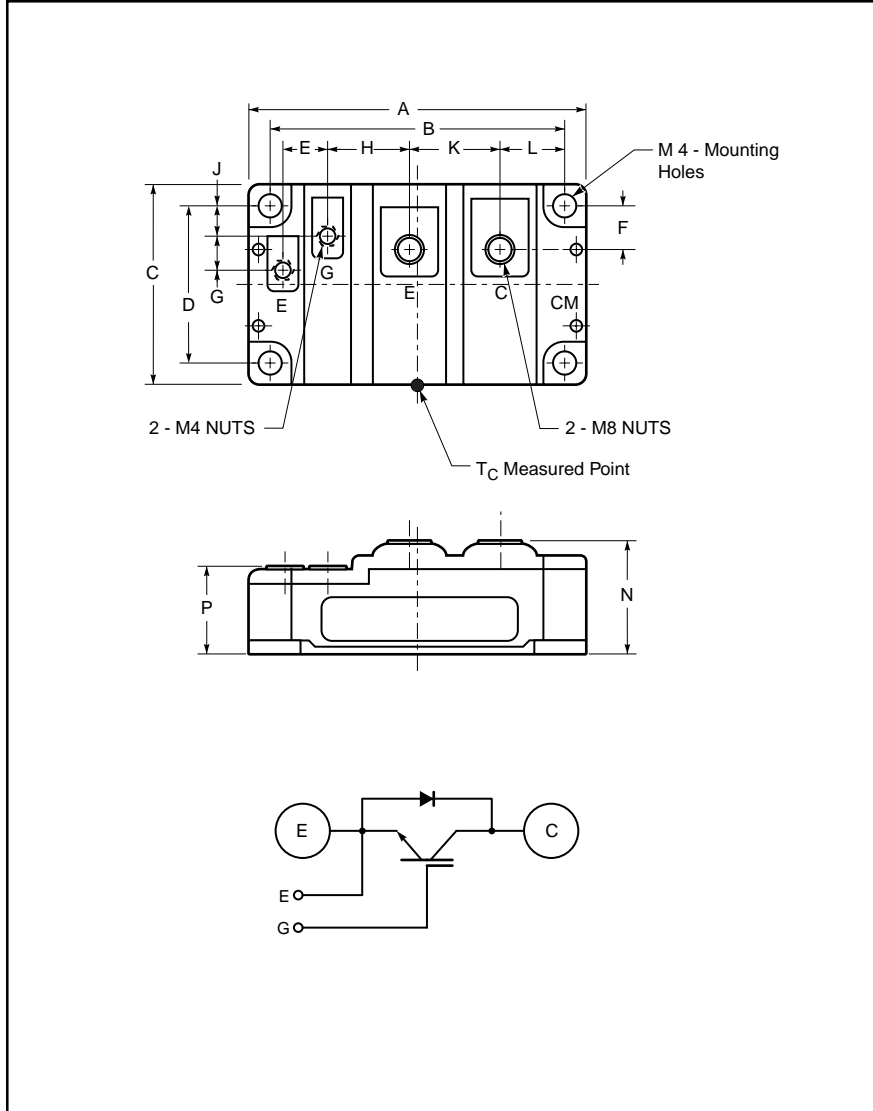

Outline Drawing and Circuit Diagram

Dimensions	Inches	Millimeters
A	4.21	107.0
B	3.66±0.01	93.0±0.25
C	2.44	62.0
D	1.89±0.01	48.0±0.25
E	0.53	13.5
F	0.49	12.55
G	0.39	10.0

Dimensions	Inches	Millimeters
H	1.02	26.0
J	0.37	9.5
K	1.14	29.0
L	0.81	20.5
M	0.26 Dia.	6.5 Dia.
N	1.34 +0.04/-0.02	34 +1.0/-0.5
P	1.02 +0.04/-0.02	26 +1.0/-0.5



Description:

Powerex IGBTMOD™ Modules are designed for use in switching applications. Each module consists of one IGBT Transistor in a single configuration with a reverse-connected super-fast recovery free-wheel diode. All components and interconnects are isolated from the heat sinking baseplate, offering simplified system assembly and thermal management.

Features:

- Low Drive Power
- Low $V_{CE(sat)}$
- Discrete Super-Fast Recovery Free-Wheel Diode
- Isolated Baseplate for Easy Heat Sinking

Applications:

- AC Motor Control
- Motion/Servo Control
- UPS
- Welding Power Supplies
- Laser Power Supplies

Ordering Information:

Example: Select the complete module number you desire from the table - i.e. CM400HU-24H is a 1200V (V_{CES}), 400 Ampere Single IGBTMOD™ Power Module.

Type	Current Rating Amperes	V_{CES} Volts (x 50)
CM	400	24

CM400HU-24H
Single IGBTMOD™ U-Series Module
 400 Amperes/1200 Volts

Absolute Maximum Ratings, $T_j = 25\text{ }^\circ\text{C}$ unless otherwise specified

Ratings	Symbol	CM400HU-24H	Units
Junction Temperature	T_j	-40 to 150	$^\circ\text{C}$
Storage Temperature	T_{stg}	-40 to 125	$^\circ\text{C}$
Collector-Emitter Voltage (G-E SHORT)	V_{CES}	1200	Volts
Gate-Emitter Voltage (C-E SHORT)	V_{GES}	± 20	Volts
Collector Current ($T_c = 25^\circ\text{C}$)	I_C	400	Amperes
Peak Collector Current ($T_j \leq 25^\circ\text{C}$)	I_{CM}	800*	Amperes
Emitter Current** ($T_c = 25^\circ\text{C}$)	I_E	400	Amperes
Peak Emitter Current**	I_{EM}	800*	Amperes
Maximum Collector Dissipation ($T_c = 25^\circ\text{C}$)	P_c	2100	Watts
Mounting Torque, M6 Main Terminal, M6 Mounting	–	40	in-lb
Mounting Torque, M4 Terminal	–	15	in-lb
Weight	–	450	Grams
Isolation Voltage (Main Terminal to Baseplate, AC 1 min.)	V_{iso}	2500	Volts

* Pulse width and repetition rate should be such that the device junction temperature (T_j) does not exceed $T_{j(max)}$ rating.

**Represents characteristics of the anti-parallel, emitter-to-collector free-wheel diode (FWDi).

Static Electrical Characteristics, $T_j = 25\text{ }^\circ\text{C}$ unless otherwise specified

Characteristics	Symbol	Test Conditions	Min.	Typ.	Max.	Units
Collector-Cutoff Current	I_{CES}	$V_{CE} = V_{CES}, V_{GE} = 0V$	–	–	2	mA
Gate Leakage Voltage	I_{GES}	$V_{GE} = V_{GES}, V_{CE} = 0V$	–	–	0.5	μA
Gate-Emitter Threshold Voltage	$V_{GE(th)}$	$I_C = 40\text{mA}, V_{CE} = 10V$	4.5	6	7.5	Volts
Collector-Emitter Saturation Voltage	$V_{CE(sat)}$	$I_C = 400\text{A}, V_{GE} = 15V, T_j = 25^\circ\text{C}$	–	2.9	3.7	Volts
		$I_C = 400\text{A}, V_{GE} = 15V, T_j = 125^\circ\text{C}$	–	2.85	–	Volts
Total Gate Charge	Q_G	$V_{CC} = 600V, I_C = 400\text{A}, V_{GE} = 15V$	–	1500	–	nC
Emitter-Collector Voltage*	V_{EC}	$I_E = 400\text{A}, V_{GE} = 0V$	–	–	3.2	Volts

* Pulse width and repetition rate should be such that the device junction temperature (T_j) does not exceed $T_{j(max)}$ rating.

Dynamic Electrical Characteristics, $T_j = 25\text{ }^\circ\text{C}$ unless otherwise specified

Characteristics	Symbol	Test Conditions	Min.	Typ.	Max.	Units	
Input Capacitance	C_{ies}		–	–	60	nf	
Output Capacitance	C_{oes}	$V_{CE} = 10V, V_{GE} = 0V$	–	–	21	nf	
Reverse Transfer Capacitance	C_{res}		–	–	12	nf	
Resistive	Turn-on Delay Time	$t_{d(on)}$	$V_{CC} = 600V, I_C = 400\text{A},$	–	–	250	ns
	Rise Time	t_r	$V_{GE1} = V_{GE2} = 15V,$	–	–	350	ns
Switch	Turn-off Delay Time	$t_{d(off)}$	$R_G = 0.78\Omega, \text{Resistive}$	–	–	350	ns
	Fall Time	t_f	Load Switching Operation	–	–	350	ns
Diode Reverse Recovery Time	t_{rr}	$I_E = 400\text{A}, di_E/dt = -800\text{A}/\mu\text{s}$	–	–	300	ns	
Diode Reverse Recovery Charge	Q_{rr}	$I_E = 400\text{A}, di_E/dt = -800\text{A}/\mu\text{s}$	–	2.2	–	μC	

Thermal and Mechanical Characteristics, $T_j = 25\text{ }^\circ\text{C}$ unless otherwise specified

Characteristics	Symbol	Test Conditions	Min.	Typ.	Max.	Units
Thermal Resistance, Junction to Case	$R_{th(j-c)Q}$	Per IGBT Module	–	–	0.06	$^\circ\text{C}/\text{W}$
Thermal Resistance, Junction to Case	$R_{th(j-c)D}$	Per FWDi Module	–	–	0.09	$^\circ\text{C}/\text{W}$
Contact Thermal Resistance	$R_{th(c-f)}$	Per Module, Thermal Grease Applied	–	0.02	–	$^\circ\text{C}/\text{W}$

CM400HU-24H
Single IGBTMOD™ U-Series Module
 400 Amperes/1200 Volts

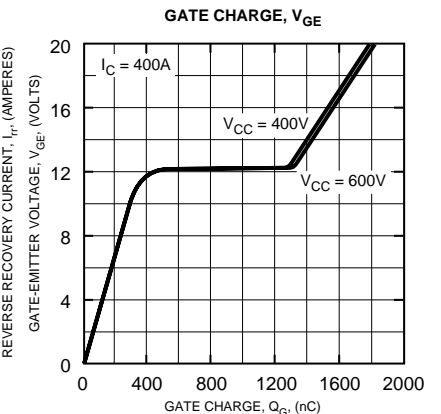
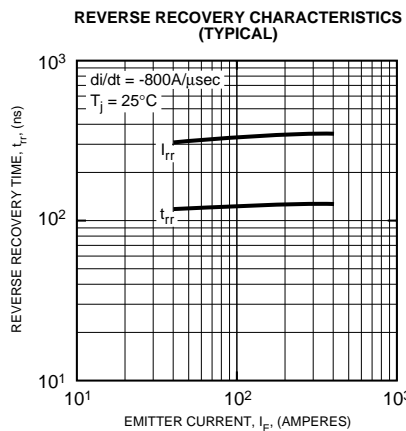
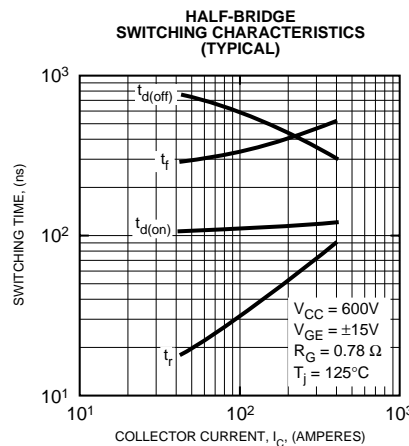
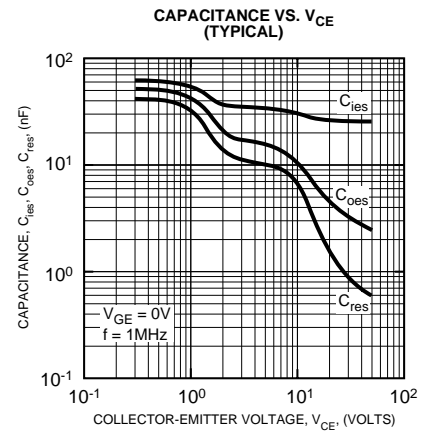
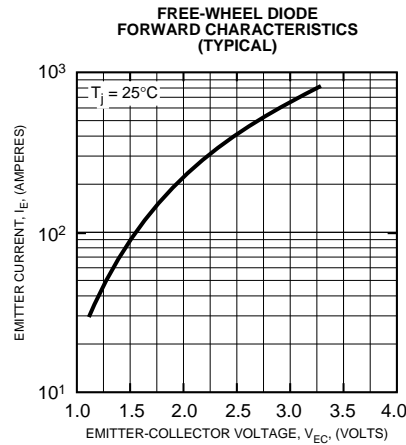
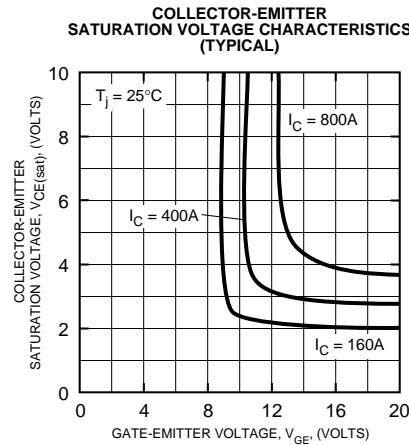
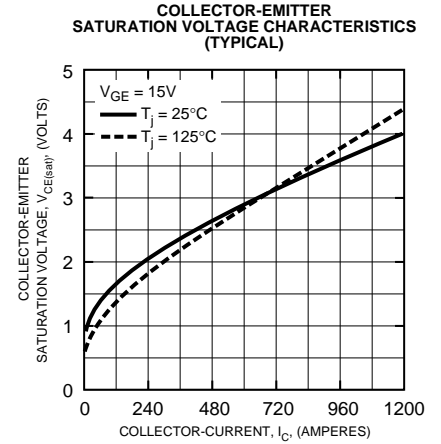
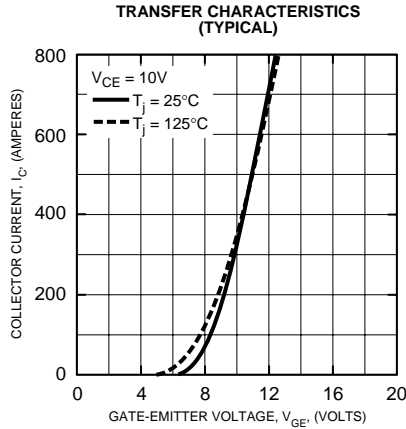
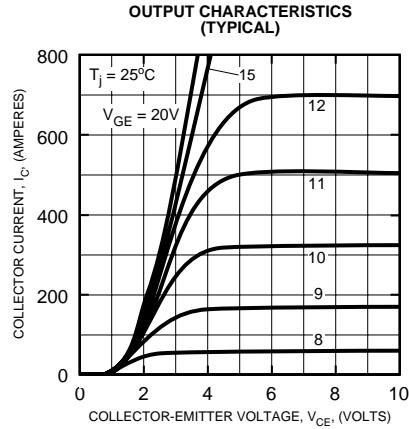

CM400HU-24H
Single IGBTMOD™ U-Series Module
 400 Amperes/1200 Volts

