

CATEGORY	DESCRIPTION	P/N #
CONNECTOR	RJ45 8P8C with LED H=2.8mm	MJ881B-BX11-HRVLX1-X

REV.	ECN NO	DESCRIPTION	REVISED	DATE
A01		New Release	XSY	2017.02.13
A02		Add LED lighting options	XSY	2018.05.10

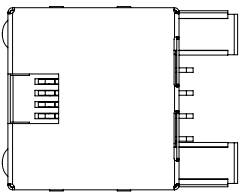

MJ881B-BX11-HRVLX1-X

X	Terminal Plating
0	Au 1u" Plating
1	Au 3u" Plating
2	Au 6u" Plating
3	Au 15u" Plating
4	Au 30u" Plating

X	LED-L	LED-R
1	GREEN	YELLOW
2	YELLOW	GREEN
3	GREEN	GREEN/ORANGE

X	Packing
C	Tape
P	Tray

- SPECIFICATION**
- VOLTAGE RATING: 125 VAC RMS.
 - CURRENT RATING: 1.5 AMP
 - CONTACT RESISTANCE: 40 mΩ MAX
 - INSULATION RESISTANCE: 500MΩ MIN.
 - WITHSTAND VOLTAGE: AC1000V RMS 50Hz or 60Hz MIN.
 - OPERATING TEMPERATURE: -40°C~+80°C

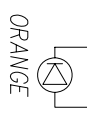
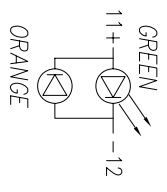
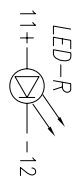
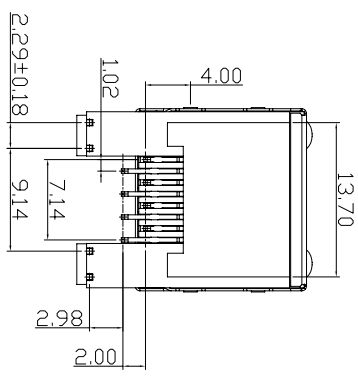
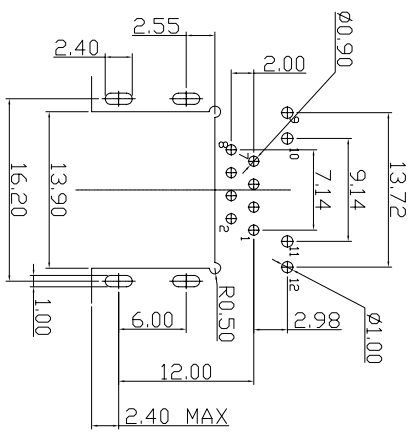
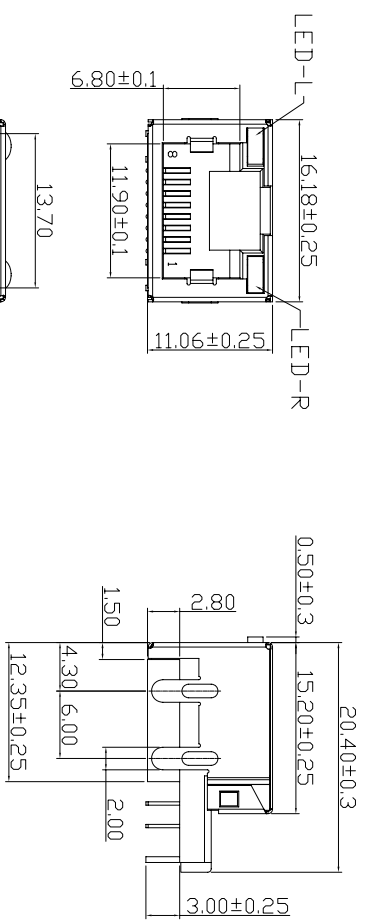

Recommend PCB Layout
(Jack Top View)
Tolerance: ±0.05mm
Recommend PCB Thickness: 1.6mm

f	LED-R	1	See Table	Tin PALTING	
e	LED-L	1	See Table	Tin PALTING	
d	SHELL	1	BRASS T=0.2mm	NI PALTING	
c	TERMINAL	8	PHOSPHOR BRONZE T=0.3mm	AU PALTING	
b	COVER	1	LCP UL94V-0	BLACK	
a	HOUSING	1	LCP UL94V-0	BLACK	
NO.	PART NAME	QTY	MATERIAL	PLATING & COLOR	Remark

UNLESS OTHERWISE SPECIFIED TOLERANCES

DECIMALS: ANGLES:
X :±0.5 X :±2
XX :±0.3 XX :±1*
XXX :±0.2

SCALE: 1/1	UNIT: mm	DWG.NO:
SIZE: A3	PAGE: 1 OF 1	REV: A02
APPROVED BY	CHECKED BY	PREPARED BY
DICK	XSY	XSY

东莞市合陵电子有限公司
DongGuan Heling Electronic Co.,LTD

CUSTOMER COPY