

High Accuracy, Hall-Effect-Based, 200 kHz Bandwidth, Galvanically Isolated Current Sensor IC with 100 $\mu\Omega$ Current Conductor

FEATURES AND BENEFITS

- AEC-Q100 Grade 1 qualified
- Typical of 2.5 μs output response time
- 5 V supply operation
- Ultra-low power loss: 100 $\mu\Omega$ internal conductor resistance
- Reinforced galvanic isolation allows use in economical, high-side current sensing in high-voltage systems
- 4800 Vrms dielectric strength certified under UL60950-1
- Industry-leading noise performance with greatly improved bandwidth through proprietary amplifier and filter design techniques
- Integrated shield greatly reduces capacitive coupling from current conductor to die due to high dV/dt signals, and prevents offset drift in high-side, high-voltage applications
- Greatly improved total output error through digitally programmed and compensated gain and offset over the full operating temperature range
- Small package size, with easy mounting capability
- Monolithic Hall IC for high reliability
- Output voltage proportional to AC or DC currents
- Factory-trimmed for accuracy
- Extremely stable output offset voltage



PACKAGE: 5-pin package (suffix CB)



Not to scale

DESCRIPTION

The Allegro™ ACS772 family of current sensor ICs provide economical and precise solutions for AC or DC current sensing, ideal for motor control, load detection and management, power supply and DC-to-DC converter control, and inverter control. The 2.5 μs response time enables overcurrent fault detection in safety-critical applications.

The device consists of a precision, low-offset linear Hall circuit with a copper conduction path located near the die. Applied current flowing through this copper conduction path generates a magnetic field which the Hall IC converts into a proportional voltage. Device accuracy is optimized through the close proximity of the magnetic signal to the Hall transducer. A precise, proportional output voltage is provided by the low-offset, chopper-stabilized BiCMOS Hall IC, which is programmed for accuracy at the factory. Proprietary digital temperature compensation technology greatly improves the IC accuracy and temperature stability.

High-level immunity to current conductor dV/dt and stray electric fields is offered by Allegro proprietary integrated shield technology for low output voltage ripple and low offset drift in high-side, high-voltage applications.

The output of the device increases when an increasing current flows through the primary copper conduction path (from terminal 4 to terminal 5), which is the path used for current sampling. The internal resistance of this conductive path is 100 $\mu\Omega$ typical, providing low power loss.

The thickness of the copper conductor allows survival of the device at high overcurrent conditions. The terminals of the conductive path are electrically isolated from the signal leads (pins 1 through 3). This allows the ACS772 family of sensor ICs to be used in applications requiring electrical isolation without the use of opto-isolators or other costly isolation techniques.

Continued on the next page...

Application 1: the ACS772 outputs an analog signal, V_{OUT} , that varies linearly with the bidirectional AC or DC primary sensed current, I_{P} , within the range specified. R_{F} and C_{F} are for optimal noise management, with values that depend on the application.

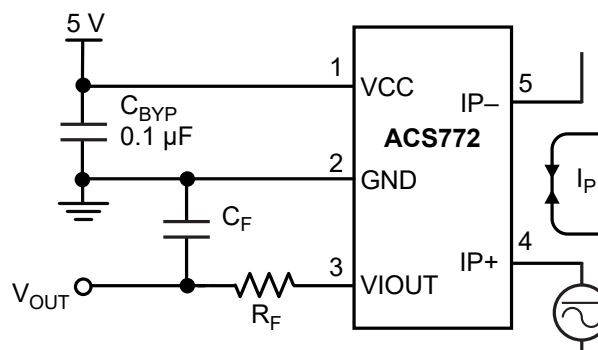

Typical Application

DESCRIPTION (continued)

The device is fully calibrated prior to shipment from the factory. The ACS772 family is lead (Pb) free. All leads are plated with 100% matte tin, and there is no Pb inside the package. The heavy gauge leadframe is made of oxygen-free copper.

SELECTION GUIDE

| Part Number [1] | Package | | Primary Sampled Current, I_p (A) | Sensitivity Sens (Typ.) (mV/A) [2] | Nominal T_A [3] (°C) | Packing [4] |
|----------------------|-----------|-------------|------------------------------------|------------------------------------|------------------------|--------------------|
| | Terminals | Signal Pins | | | | |
| ACS772LCB-050U-PFF-T | Formed | Formed | 50 | 80 | -40 to 150 | 34 pieces per tube |
| ACS772LCB-050B-PFF-T | Formed | Formed | ± 50 | 40 | | |
| ACS772LCB-050B-PSS-T | Straight | Straight | | | | |
| ACS772LCB-100U-PFF-T | Formed | Formed | 100 | 40 | | |
| ACS772LCB-100B-PFF-T | Formed | Formed | ± 100 | 20 | | |
| ACS772KCB-150U-PFF-T | Formed | Formed | 150 | 26.66 | -40 to 125 | |
| ACS772KCB-150B-PFF-T | Formed | Formed | ± 150 | 13.33 | | |
| ACS772ECB-200U-PFF-T | Formed | Formed | 200 | 20 | -40 to 85 | |
| ACS772ECB-200B-PFF-T | Formed | Formed | ± 200 | 10 | | |
| ACS772ECB-250U-PFF-T | Formed | Formed | 250 | 16 | | |
| ACS772ECB-250U-PSF-T | Straight | Formed | | | | |
| ACS772ECB-250B-PFF-T | Formed | Formed | ± 250 | 8 | | |
| ACS772ECB-250B-PSF-T | Straight | Formed | | | | |
| ACS772ECB-300B-PFF-T | Formed | Formed | ± 300 | 6.66 | | |
| ACS772ECB-400B-PFF-T | Formed | Formed | ± 400 | 5 | | |

[1] Additional leadform and Sensitivity options available for qualified volumes.

[2] Measured at $V_{CC} = 5 V$.

[3] All ACS772 devices are production tested and guaranteed to $T_A = 150^\circ C$, provided the Maximum Junction Temperature, $T_{J(MAX)}$, is not exceeded. See Absolute Maximum Ratings and Thermal Application section of this datasheet for more information.

[4] Contact Allegro for additional packing options.

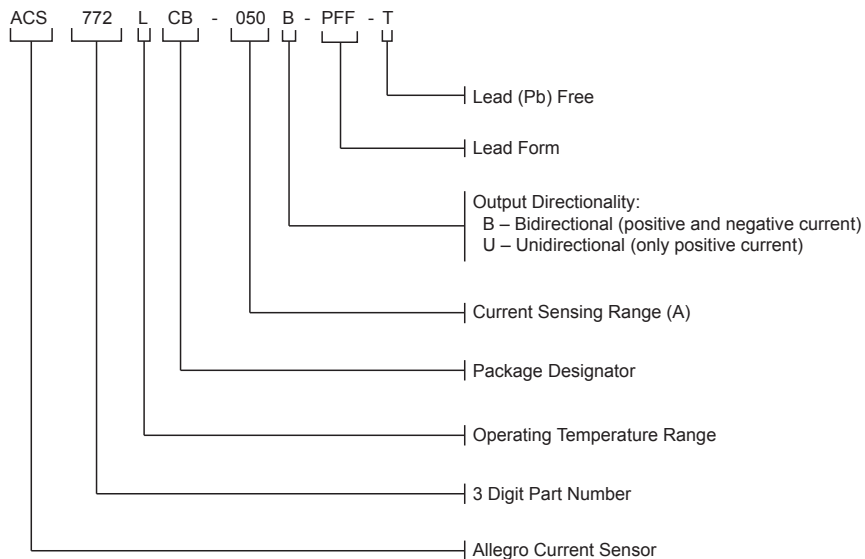

ABSOLUTE MAXIMUM RATINGS

| Characteristic | Symbol | Notes | Rating | Unit |
|-----------------------------------|-------------------|--|------------|-------------|
| Supply Voltage | V_{CC} | | 6.5 | V |
| Reverse Supply Voltage | V_{RCC} | | -0.5 | V |
| Output Voltage | V_{IOUT} | | 6.5 | V |
| Reverse Output Voltage | V_{RIOUT} | | -0.5 | V |
| Output Source Current | $I_{OUT(SOURCE)}$ | V _{IOUT} to GND | 3 | mA |
| Output Sink Current | $I_{OUT(SINK)}$ | Minimum pull-up resistor of 500 Ω from V _{CC} to V _{IOUT} | 10 | mA |
| Operating Ambient Temperature [1] | T_A | Range E, K, and L | -40 to 150 | $^{\circ}C$ |
| Maximum Junction Temperature | $T_{J(max)}$ | | 165 | $^{\circ}C$ |
| Storage Temperature | T_{stg} | | -65 to 165 | $^{\circ}C$ |

[1] All ACS772 devices are production tested and guaranteed to $T_A = 150^{\circ}C$, provided the Maximum Junction Temperature, $T_{J(MAX)}$, is not exceeded. See Thermal Application section of this datasheet for more information.

ISOLATION CHARACTERISTICS

| Characteristic | Symbol | Notes | Rating | Unit |
|--|-------------|--|--------|----------------------|
| Dielectric Surge Strength Test Voltage | V_{SURGE} | Tested ± 5 pulses at 2/minute in compliance to IEC 61000-4-5 1.2 μs (rise) / 50 μs (width) | 8000 | V |
| Dielectric Strength Test Voltage [2] | V_{ISO} | Agency type-tested for 60 seconds per UL standard 60950-1, 2nd Edition. Tested at 3000 V_{RMS} for 1 second in production. | 4800 | V_{RMS} |
| Working Voltage for Basic Isolation | V_{WVBI} | For basic (single) isolation per UL standard 60950-1, 2nd Edition | 990 | V_{PK} or V_{DC} |
| | | | 700 | V_{RMS} |
| Working Voltage for Reinforced Isolation | V_{WFRI} | For reinforced (double) isolation per UL standard 60950-1, 2nd Edition | 636 | V_{PK} or V_{DC} |
| | | | 450 | V_{RMS} |

[2] Allegro does not conduct 60-second testing. It is done only during the UL certification process.

THERMAL CHARACTERISTICS: May require derating at maximum conditions

| Characteristic | Symbol | Test Conditions [3] | Value | Unit |
|----------------------------|-----------------|---|-------|---------------|
| Package Thermal Resistance | $R_{\theta JA}$ | Mounted on the Allegro evaluation board with 2800 mm ² (1400 mm ² on component side and 1400 mm ² on opposite side) of 4 oz. copper connected to the primary leadframe and with thermal vias connecting the copper layers. Performance is based on current flowing through the primary leadframe and includes the power consumed by the PCB. | 7 | $^{\circ}C/W$ |

[3] Additional thermal information available on the Allegro website.

TYPICAL OVERCURRENT CAPABILITIES [4][5]

| Characteristic | Symbol | Notes | Rating | Unit |
|----------------|-----------|--|--------|------|
| Overcurrent | I_{POC} | $T_A = 25^{\circ}C$; current is on for 1 second and off for 99 seconds, 100 pulses applied | 1200 | A |
| | | $T_A = 85^{\circ}C$; current is on for 1 second and off for 99 seconds, 100 pulses applied | 900 | A |
| | | $T_A = 150^{\circ}C$; current is on for 1 second and off for 99 seconds, 100 pulses applied | 600 | A |

[4] Test was done with Allegro evaluation board. The maximum allowed current is limited by $T_{J(max)}$ only.

[5] For more overcurrent profiles, please see FAQ on the Allegro website, www.allegromicro.com.

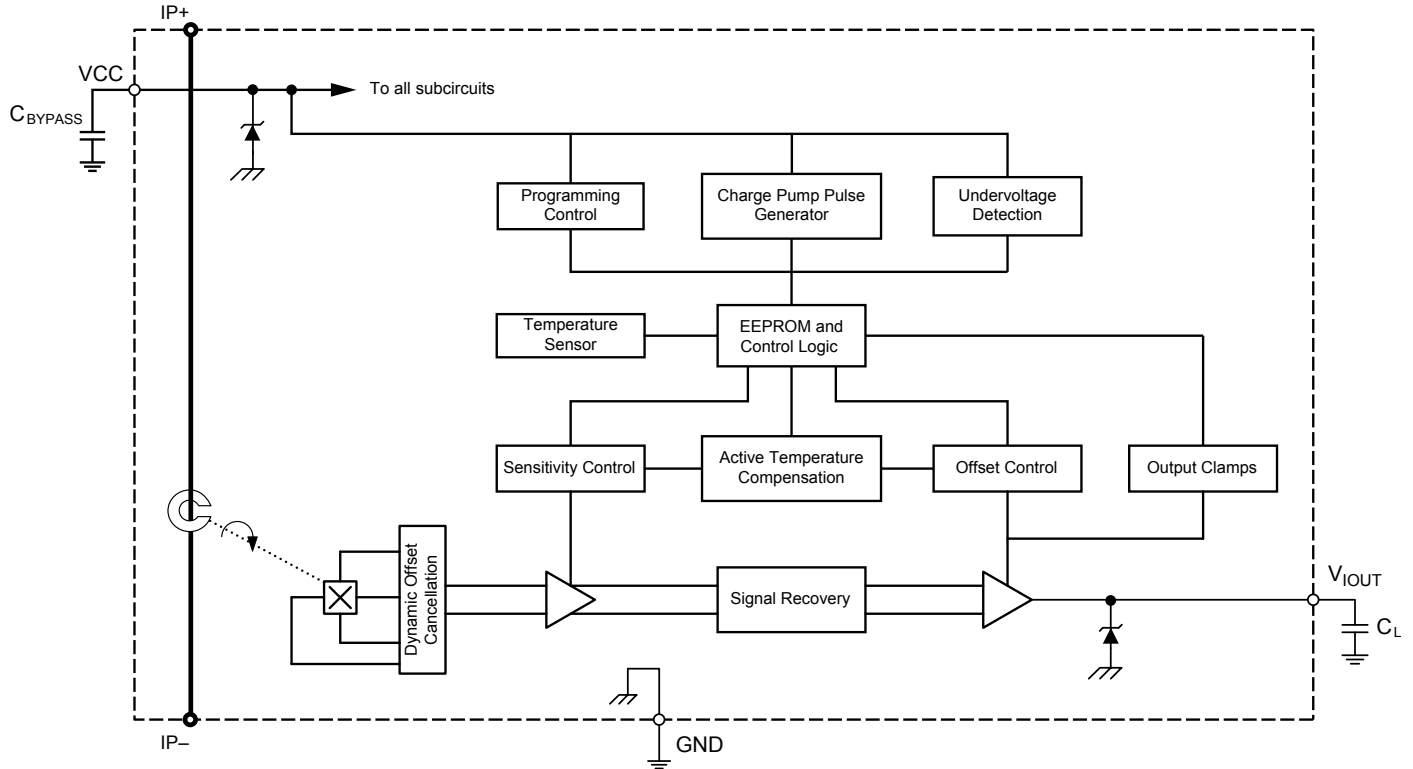

Functional Block Diagram

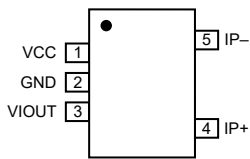

Pinout Diagram

Terminal List Table

| Number | Name | Description |
|--------|--------|------------------------------------|
| 1 | VCC | Device power supply terminal |
| 2 | GND | Signal ground terminal |
| 3 | V_IOUT | Analog output signal |
| 4 | IP+ | Terminal for current being sampled |
| 5 | IP- | Terminal for current being sampled |

COMMON OPERATING CHARACTERISTICS: Valid at $T_A = -40^\circ\text{C}$ to 150°C , $C_{BYP} = 0.1 \mu\text{F}$, and $V_{CC} = 5 \text{ V}$, unless otherwise specified

| Characteristic | Symbol | Test Conditions | Min. | Typ. | Max. | Unit |
|--|------------------------|--|----------------|------------|------|------------------------------|
| ELECTRICAL CHARACTERISTICS | | | | | | |
| Supply Voltage | V_{CC} | | 4.5 | 5 | 5.5 | V |
| Supply Current | I_{CC} | $V_{CC} = 5 \text{ V}$, no load on output | – | 10 | 15 | mA |
| Power-On Delay | t_{POD} | $T_A = 25^\circ\text{C}$ | – | 64 | – | μs |
| Undervoltage Lockout (UVLO) Threshold ^[1] | V_{UVLOH} | V_{CC} rising at 1 V/ms and device functions enabled | – | 4 | – | V |
| | V_{UVLOL} | V_{CC} falling at 1 V/ms and device functions enabled | – | 3.5 | – | V |
| UVLO Hysteresis | $V_{HYS(UVLO)}$ | | 250 | – | – | mV |
| UVLO Enable/Disable Delay Time ^[1] | t_{UVLOE} | Time measured from falling $V_{CC} < V_{UVLOH}$ to UVLO enabled | – | 64 | – | μs |
| | t_{UVLOD} | Time measured from rising $V_{CC} > V_{UVLOH}$ to UVLO disabled | – | 7 | – | μs |
| Power-On Reset Voltage | V_{PORH} | V_{CC} rising at 1 V/ms | – | 2.9 | – | V |
| | V_{PORL} | V_{CC} falling at 1 V/ms | – | 2.5 | – | V |
| POR Hysteresis | $V_{HYS(POR)}$ | | 250 | – | – | mV |
| Internal Bandwidth | BW_i | Small signal –3 dB, $C_L = 0.47 \text{ nF}$ | – | 200 | – | kHz |
| Rise Time | t_r | I_P step = 50% of I_{P+} , 10% to 90% rise time, $T_A = 25^\circ\text{C}$, $C_{OUT} = 470 \text{ pF}$ | – | 2.4 | – | μs |
| Propagation Delay Time | t_{PROP} | $T_A = 25^\circ\text{C}$, $C_L = 470 \text{ pF}$, IP step = 50% of IP+ | – | 1.2 | – | μs |
| Response Time | $t_{RESPONSE}$ | $T_A = 25^\circ\text{C}$, $C_L = 470 \text{ pF}$, IP step = 50% of IP+, 90% input to 90% output | – | 2.5 | – | μs |
| DC Output Impedance | R_{OUT} | $T_A = 25^\circ\text{C}$ | – | 3.3 | – | Ω |
| Output Load Resistance | $R_{LOAD(MIN)}$ | VIOUT to GND, VIOUT to VCC | 4.7 | – | – | k Ω |
| Output Load Capacitance | $C_{LOAD(MAX)}$ | VIOUT to GND | – | 1 | 10 | nF |
| Primary Conductor Resistance | $R_{PRIMARY}$ | $T_A = 25^\circ\text{C}$ | – | 100 | – | $\mu\Omega$ |
| Output Saturation Voltage | $V_{SAT(HIGH)}$ | $T_A = 25^\circ\text{C}$, $R_{L(PULLDOWN)} = 10 \text{ k}\Omega$ to GND | $V_{CC} - 0.2$ | – | – | V |
| | $V_{SAT(LOW)}$ | $T_A = 25^\circ\text{C}$, $R_{L(PULLUP)} = 10 \text{ k}\Omega$ to VCC | – | – | 200 | mV |
| ERROR COMPONENTS | | | | | | |
| QVO Ratiometry Error ^[2] | Rat_{ERRQVO} | $V_{CC} = 4.75$ to 5.25 V | – | ± 0.15 | – | % |
| Sens Ratiometry Error ^[2] | $\text{Rat}_{ERRSens}$ | $V_{CC} = 4.75$ to 5.25 V | – | ± 0.3 | – | % |
| Noise | I_N | Input referenced noise density; $T_A = 25^\circ\text{C}$, $C_L = 1 \text{ nF}$ | – | 0.15 | – | $\text{mA}/\sqrt{\text{Hz}}$ |
| | | Input referenced noise at 200 kHz; $T_A = 25^\circ\text{C}$, $C_L = 1 \text{ nF}$ | – | 85 | – | mA_{RMS} |
| Nonlinearity ^[2] | E_{LIN} | Up to full scale of I_P | –0.9 | ± 0.5 | 0.9 | % |
| Symmetry ^[2] | E_{SYM} | Over half-scale I_P | –0.8 | ± 0.4 | 0.8 | % |

^[1] UVLO feature is only available on part numbers programmed to work at $V_{CC} = 5 \text{ V}$.

^[2] See Characteristic Definitions section of this datasheet.

X050U PERFORMANCE CHARACTERISTICS: $T_A = -40^\circ\text{C}$ to 150°C [1], $V_{CC} = 5\text{ V}$, unless otherwise specified

| Characteristic | Symbol | Test Conditions | Min. | Typ. [2] | Max. | Unit |
|--|----------------------|---|-------|------------------------|------|-------------------|
| NOMINAL PERFORMANCE | | | | | | |
| Current Sensing Range | I_{PR} | | 0 | – | 50 | A |
| Sensitivity | Sens | $I_{PR(\min)} < I_P < I_{PR(\max)}$ | – | $80 \times V_{CC} / 5$ | – | mV/A |
| Zero Current Output Voltage | $V_{IOUT(Q)}$ | Unidirectional; $I_P = 0\text{ A}$ | – | $V_{CC} / 10$ | – | V |
| ACCURACY PERFORMANCE | | | | | | |
| Noise | V_N | $T_A = 25^\circ\text{C}$, $C_L = 1\text{ nF}$ | – | 20.4 | – | mV _{p-p} |
| | | $T_A = 25^\circ\text{C}$, $C_L = 1\text{ nF}$ | – | 3.4 | – | mV _{RMS} |
| Sensitivity Error | E_{Sens} | Full scale of I_P , $T_A = 25^\circ\text{C}$ | –1 | ± 0.7 | 1 | % |
| | | Full scale of I_P , $T_A = 25^\circ\text{C}$ to 150°C | –1.25 | ± 0.8 | 1.25 | % |
| | | Full scale of I_P , $T_A = -40^\circ\text{C}$ to 25°C | –3.5 | ± 1.7 | 3.5 | % |
| Electrical Offset Error | $V_{OE(TA)}$ | $I_P = 0\text{ A}$, $T_A = 25^\circ\text{C}$ | –8 | ± 4 | 8 | mV |
| | $V_{OE(TA)HT}$ | $I_P = 0\text{ A}$, $T_A = 25^\circ\text{C}$ to 150°C | –8 | ± 4 | 8 | mV |
| | $V_{OE(TA)LT}$ | $I_P = 0\text{ A}$, $T_A = -40^\circ\text{C}$ to 25°C | –20 | ± 6 | 20 | mV |
| Magnetic Offset Error | I_{ERROM} | $I_P = 0\text{ A}$, $T_A = 25^\circ\text{C}$, after excursion of $I_{PR(\max)}$ | – | 120 | 250 | mA |
| Total Output Error | $E_{TOT(HT)}$ | Full scale of I_P , $T_A = 25^\circ\text{C}$ to 150°C | –1.5 | ± 0.9 | 1.5 | % |
| | $E_{TOT(LT)}$ | Full scale of I_P , $T_A = -40^\circ\text{C}$ to 25°C | –3.5 | ± 1.7 | 3.5 | % |
| LIFETIME ACCURACY CHARACTERISTICS [3] | | | | | | |
| Sensitivity Error Including Lifetime | $E_{Sens(LIFE)(HT)}$ | $T_A = 25^\circ\text{C}$ to 150°C | –2.1 | ± 1.6 | 2.1 | % |
| | $E_{Sens(LIFE)(LT)}$ | $T_A = -40^\circ\text{C}$ to 25°C | –3.5 | ± 2.5 | 3.5 | % |
| Total Output Error Including Lifetime | $E_{TOT(LIFE)(HT)}$ | $T_A = 25^\circ\text{C}$ to 150°C | –2.1 | ± 1.7 | 2.1 | % |
| | $E_{TOT(LIFE)(LT)}$ | $T_A = -40^\circ\text{C}$ to 25°C | –3.5 | ± 2.6 | 3.5 | % |
| Electric Offset Error Including Lifetime | $E_{OFF(LIFE)(HT)}$ | $T_A = 25^\circ\text{C}$ to 150°C | –10 | ± 7 | 10 | mV |
| | $E_{OFF(LIFE)(LT)}$ | $T_A = -40^\circ\text{C}$ to 25°C | –20 | ± 8.9 | 20 | mV |

[1] All ACS772 devices are production tested and guaranteed to $T_A = 150^\circ\text{C}$, provided the Maximum Junction Temperature, $T_{J(\text{MAX})}$, is not exceeded. See Absolute Maximum Ratings and Thermal Application section of this datasheet for more information.

[2] Typical values are ± 3 sigma values.

[3] Min/max limits are derived from AEC-Q100 Grade 1 testing.

X050B PERFORMANCE CHARACTERISTICS: $T_A = -40^\circ\text{C}$ to 150°C [1], $V_{CC} = 5\text{ V}$, unless otherwise specified

| Characteristic | Symbol | Test Conditions | Min. | Typ. [2] | Max. | Unit |
|--|----------------------|---|-------|------------------------|------|-------------------|
| NOMINAL PERFORMANCE | | | | | | |
| Current Sensing Range | I_{PR} | | -50 | - | 50 | A |
| Sensitivity | Sens | $I_{PR(\min)} < I_P < I_{PR(\max)}$ | - | $40 \times V_{CC} / 5$ | - | mV/A |
| Zero Current Output Voltage | $V_{IOUT(Q)}$ | Bidirectional; $I_P = 0\text{ A}$ | - | $V_{CC} / 2$ | - | V |
| ACCURACY PERFORMANCE | | | | | | |
| Noise | V_N | $T_A = 25^\circ\text{C}$, $C_L = 1\text{ nF}$ | - | 20.4 | - | mV _{p-p} |
| | | $T_A = 25^\circ\text{C}$, $C_L = 1\text{ nF}$ | - | 3.4 | - | mV _{RMS} |
| Sensitivity Error | E_{Sens} | Full scale of I_P , $T_A = 25^\circ\text{C}$ | -1 | ± 0.7 | 1 | % |
| | | Full scale of I_P , $T_A = 25^\circ\text{C}$ to 150°C | -1.25 | ± 0.8 | 1.25 | % |
| | | Full scale of I_P , $T_A = -40^\circ\text{C}$ to 25°C | -3.5 | ± 1.7 | 3.5 | % |
| Electrical Offset Error | $V_{OE(TA)}$ | $I_P = 0\text{ A}$, $T_A = 25^\circ\text{C}$ | -8 | ± 4 | 8 | mV |
| | $V_{OE(TA)HT}$ | $I_P = 0\text{ A}$, $T_A = 25^\circ\text{C}$ to 150°C | -8 | ± 4 | 8 | mV |
| | $V_{OE(TA)LT}$ | $I_P = 0\text{ A}$, $T_A = -40^\circ\text{C}$ to 25°C | -20 | ± 6 | 20 | mV |
| Magnetic Offset Error | I_{ERROM} | $I_P = 0\text{ A}$, $T_A = 25^\circ\text{C}$, after excursion of $I_{PR(\max)}$ | - | 210 | 250 | mA |
| Total Output Error | $E_{TOT(HT)}$ | Full scale of I_P , $T_A = 25^\circ\text{C}$ to 150°C | -1.5 | ± 0.9 | 1.5 | % |
| | $E_{TOT(LT)}$ | Full scale of I_P , $T_A = -40^\circ\text{C}$ to 25°C | -3.5 | ± 1.7 | 3.5 | % |
| LIFETIME ACCURACY CHARACTERISTICS [3] | | | | | | |
| Sensitivity Error Including Lifetime | $E_{Sens(LIFE)(HT)}$ | $T_A = 25^\circ\text{C}$ to 150°C | -2.1 | ± 1.6 | 2.1 | % |
| | $E_{Sens(LIFE)(LT)}$ | $T_A = -40^\circ\text{C}$ to 25°C | -3.5 | ± 2.5 | 3.5 | % |
| Total Output Error Including Lifetime | $E_{TOT(LIFE)(HT)}$ | $T_A = 25^\circ\text{C}$ to 150°C | -2.1 | ± 1.7 | 2.1 | % |
| | $E_{TOT(LIFE)(LT)}$ | $T_A = -40^\circ\text{C}$ to 25°C | -3.5 | ± 2.6 | 3.5 | % |
| Electric Offset Error Including Lifetime | $E_{OFF(LIFE)(HT)}$ | $T_A = 25^\circ\text{C}$ to 150°C | -10 | ± 7 | 10 | mV |
| | $E_{OFF(LIFE)(LT)}$ | $T_A = -40^\circ\text{C}$ to 25°C | -20 | ± 8.9 | 20 | mV |

[1] All ACS772 devices are production tested and guaranteed to $T_A = 150^\circ\text{C}$, provided the Maximum Junction Temperature, $T_{J(\text{MAX})}$, is not exceeded. See Absolute Maximum Ratings and Thermal Application section of this datasheet for more information.

[2] Typical values are ± 3 sigma values.

[3] Min/max limits are derived from AEC-Q100 Grade 1 testing.

X100U PERFORMANCE CHARACTERISTICS: $T_A = -40^\circ\text{C}$ to 150°C [1], $V_{CC} = 5\text{ V}$, unless otherwise specified

| Characteristic | Symbol | Test Conditions | Min. | Typ. [2] | Max. | Unit |
|--|-----------------------------|---|-------|------------------------|------|-------------------|
| NOMINAL PERFORMANCE | | | | | | |
| Current Sensing Range | I_{PR} | | 0 | – | 100 | A |
| Sensitivity | Sens | $I_{PR(\text{min})} < I_P < I_{PR(\text{max})}$ | – | $40 \times V_{CC} / 5$ | – | mV/A |
| Zero Current Output Voltage | $V_{IOUT(Q)}$ | Unidirectional; $I_P = 0\text{ A}$ | – | $V_{CC} / 10$ | – | V |
| ACCURACY PERFORMANCE | | | | | | |
| Noise | V_N | $T_A = 25^\circ\text{C}$, $C_L = 1\text{ nF}$ | – | 20.4 | – | mV _{p-p} |
| | | $T_A = 25^\circ\text{C}$, $C_L = 1\text{ nF}$ | – | 3.4 | – | mV _{RMS} |
| Sensitivity Error | E_{Sens} | Full scale of I_P , $T_A = 25^\circ\text{C}$ | –1 | ± 0.7 | 1 | % |
| | | Full scale of I_P , $T_A = 25^\circ\text{C}$ to 150°C | –1.25 | ± 0.8 | 1.25 | % |
| | | Full scale of I_P , $T_A = -40^\circ\text{C}$ to 25°C | –3.5 | ± 1.7 | 3.5 | % |
| Electrical Offset Error | $V_{OE(TA)}$ | $I_P = 0\text{ A}$, $T_A = 25^\circ\text{C}$ | –8 | ± 4 | 8 | mV |
| | $V_{OE(TA)HT}$ | $I_P = 0\text{ A}$, $T_A = 25^\circ\text{C}$ to 150°C | –8 | ± 4 | 8 | mV |
| | $V_{OE(TA)LT}$ | $I_P = 0\text{ A}$, $T_A = -40^\circ\text{C}$ to 25°C | –20 | ± 6 | 20 | mV |
| Magnetic Offset Error | I_{ERROM} | $I_P = 0\text{ A}$, $T_A = 25^\circ\text{C}$, after excursion of $I_{PR(\text{max})}$ | – | 280 | 400 | mA |
| Total Output Error | $E_{\text{TOT}(HT)}$ | Full scale of I_P , $T_A = 25^\circ\text{C}$ to 150°C | –1.5 | ± 0.9 | 1.5 | % |
| | $E_{\text{TOT}(LT)}$ | Full scale of I_P , $T_A = -40^\circ\text{C}$ to 25°C | –3.5 | ± 1.7 | 3.5 | % |
| LIFETIME ACCURACY CHARACTERISTICS [3] | | | | | | |
| Sensitivity Error Including Lifetime | $E_{\text{Sens}(LIFE)(HT)}$ | $T_A = 25^\circ\text{C}$ to 150°C | –2.1 | ± 1.6 | 2.1 | % |
| | $E_{\text{Sens}(LIFE)(LT)}$ | $T_A = -40^\circ\text{C}$ to 25°C | –3.5 | ± 2.5 | 3.5 | % |
| Total Output Error Including Lifetime | $E_{\text{TOT}(LIFE)(HT)}$ | $T_A = 25^\circ\text{C}$ to 150°C | –2.1 | ± 1.7 | 2.1 | % |
| | $E_{\text{TOT}(LIFE)(LT)}$ | $T_A = -40^\circ\text{C}$ to 25°C | –3.5 | ± 2.6 | 3.5 | % |
| Electric Offset Error Including Lifetime | $E_{\text{OFF}(LIFE)(HT)}$ | $T_A = 25^\circ\text{C}$ to 150°C | –10 | ± 7 | 10 | mV |
| | $E_{\text{OFF}(LIFE)(LT)}$ | $T_A = -40^\circ\text{C}$ to 25°C | –20 | ± 8.9 | 20 | mV |

[1] All ACS772 devices are production tested and guaranteed to $T_A = 150^\circ\text{C}$, provided the Maximum Junction Temperature, $T_{J(\text{MAX})}$, is not exceeded. See Absolute Maximum Ratings and Thermal Application section of this datasheet for more information.

[2] Typical values are ± 3 sigma values.

[3] Min/max limits are derived from AEC-Q100 Grade 1 testing.

X100B PERFORMANCE CHARACTERISTICS: $T_A = -40^\circ\text{C}$ to 150°C [1], $V_{CC} = 5\text{ V}$, unless otherwise specified

| Characteristic | Symbol | Test Conditions | Min. | Typ. [2] | Max. | Unit |
|--|----------------------|---|-------|------------------------|------|-------------------|
| NOMINAL PERFORMANCE | | | | | | |
| Current Sensing Range | I_{PR} | | -100 | - | 100 | A |
| Sensitivity | Sens | $I_{PR(\min)} < I_P < I_{PR(\max)}$ | - | $20 \times V_{CC} / 5$ | - | mV/A |
| Zero Current Output Voltage | $V_{IOUT(Q)}$ | Bidirectional; $I_P = 0\text{ A}$ | - | $V_{CC} / 2$ | - | V |
| ACCURACY PERFORMANCE | | | | | | |
| Noise | V_N | $T_A = 25^\circ\text{C}$, $C_L = 1\text{ nF}$ | - | 20.4 | - | mV _{p-p} |
| | | $T_A = 25^\circ\text{C}$, $C_L = 1\text{ nF}$ | - | 3.4 | - | mV _{RMS} |
| Sensitivity Error | E_{Sens} | Full scale of I_P , $T_A = 25^\circ\text{C}$ | -1 | ± 0.7 | 1 | % |
| | | Full scale of I_P , $T_A = 25^\circ\text{C}$ to 150°C | -1.25 | ± 0.8 | 1.25 | % |
| | | Full scale of I_P , $T_A = -40^\circ\text{C}$ to 25°C | -3.5 | ± 1.7 | 3.5 | % |
| Electrical Offset Error | $V_{OE(TA)}$ | $I_P = 0\text{ A}$, $T_A = 25^\circ\text{C}$ | -8 | ± 4 | 8 | mV |
| | $V_{OE(TA)HT}$ | $I_P = 0\text{ A}$, $T_A = 25^\circ\text{C}$ to 150°C | -8 | ± 4 | 8 | mV |
| | $V_{OE(TA)LT}$ | $I_P = 0\text{ A}$, $T_A = -40^\circ\text{C}$ to 25°C | -20 | ± 6 | 20 | mV |
| Magnetic Offset Error | I_{ERROM} | $I_P = 0\text{ A}$, $T_A = 25^\circ\text{C}$, after excursion of $I_{PR(\max)}$ | - | 175 | 400 | mA |
| Total Output Error | $E_{TOT(HT)}$ | Full scale of I_P , $T_A = 25^\circ\text{C}$ to 150°C | -1.5 | ± 0.9 | 1.5 | % |
| | $E_{TOT(LT)}$ | Full scale of I_P , $T_A = -40^\circ\text{C}$ to 25°C | -3.5 | ± 1.7 | 3.5 | % |
| LIFETIME ACCURACY CHARACTERISTICS [3] | | | | | | |
| Sensitivity Error Including Lifetime | $E_{Sens(LIFE)(HT)}$ | $T_A = 25^\circ\text{C}$ to 150°C | -2.1 | ± 1.6 | 2.1 | % |
| | $E_{Sens(LIFE)(LT)}$ | $T_A = -40^\circ\text{C}$ to 25°C | -3.5 | ± 2.5 | 3.5 | % |
| Total Output Error Including Lifetime | $E_{TOT(LIFE)(HT)}$ | $T_A = 25^\circ\text{C}$ to 150°C | -2.1 | ± 1.7 | 2.1 | % |
| | $E_{TOT(LIFE)(LT)}$ | $T_A = -40^\circ\text{C}$ to 25°C | -3.5 | ± 2.6 | 3.5 | % |
| Electric Offset Error Including Lifetime | $E_{OFF(LIFE)(HT)}$ | $T_A = 25^\circ\text{C}$ to 150°C | -10 | ± 7 | 10 | mV |
| | $E_{OFF(LIFE)(LT)}$ | $T_A = -40^\circ\text{C}$ to 25°C | -20 | ± 8.9 | 20 | mV |

[1] All ACS772 devices are production tested and guaranteed to $T_A = 150^\circ\text{C}$, provided the Maximum Junction Temperature, $T_{J(\text{MAX})}$, is not exceeded. See Absolute Maximum Ratings and Thermal Application section of this datasheet for more information.

[2] Typical values are ± 3 sigma values.

[3] Min/max limits are derived from AEC-Q100 Grade 1 testing.

X150U PERFORMANCE CHARACTERISTICS: $T_A = -40^\circ\text{C}$ to 150°C [1], $V_{CC} = 5\text{ V}$, unless otherwise specified

| Characteristic | Symbol | Test Conditions | Min. | Typ. [2] | Max. | Unit |
|--|----------------------|---|-------|---------------------------|------|-------------------|
| NOMINAL PERFORMANCE | | | | | | |
| Current Sensing Range | I_{PR} | | 0 | – | 150 | A |
| Sensitivity | Sens | $I_{PR(\min)} < I_P < I_{PR(\max)}$ | – | $26.66 \times V_{CC} / 5$ | – | mV/A |
| Zero Current Output Voltage | $V_{IOUT(Q)}$ | Unidirectional; $I_P = 0\text{ A}$ | – | $V_{CC} / 10$ | – | V |
| ACCURACY PERFORMANCE | | | | | | |
| Noise | V_N | $T_A = 25^\circ\text{C}$, $C_L = 1\text{ nF}$ | – | 20.4 | – | mV _{p-p} |
| | | $T_A = 25^\circ\text{C}$, $C_L = 1\text{ nF}$ | – | 3.4 | – | mV _{RMS} |
| Sensitivity Error | E_{Sens} | Full scale of I_P , $T_A = 25^\circ\text{C}$ | –1 | ± 0.7 | 1 | % |
| | | Full scale of I_P , $T_A = 25^\circ\text{C}$ to 150°C | –1.25 | ± 0.8 | 1.25 | % |
| | | Full scale of I_P , $T_A = -40^\circ\text{C}$ to 25°C | –3.5 | ± 1.7 | 3.5 | % |
| Electrical Offset Error | $V_{OE(TA)}$ | $I_P = 0\text{ A}$, $T_A = 25^\circ\text{C}$ | –8 | ± 4 | 8 | mV |
| | $V_{OE(TA)HT}$ | $I_P = 0\text{ A}$, $T_A = 25^\circ\text{C}$ to 150°C | –8 | ± 4 | 8 | mV |
| | $V_{OE(TA)LT}$ | $I_P = 0\text{ A}$, $T_A = -40^\circ\text{C}$ to 25°C | –20 | ± 6 | 20 | mV |
| Magnetic Offset Error | I_{ERROM} | $I_P = 0\text{ A}$, $T_A = 25^\circ\text{C}$, after excursion of $I_{PR(\max)}$ | – | 280 | 400 | mA |
| Total Output Error | $E_{TOT(HT)}$ | Full scale of I_P , $T_A = 25^\circ\text{C}$ to 150°C | –1.5 | ± 0.9 | 1.5 | % |
| | $E_{TOT(LT)}$ | Full scale of I_P , $T_A = -40^\circ\text{C}$ to 25°C | –3.5 | ± 1.7 | 3.5 | % |
| LIFETIME ACCURACY CHARACTERISTICS [3] | | | | | | |
| Sensitivity Error Including Lifetime | $E_{Sens(LIFE)(HT)}$ | $T_A = 25^\circ\text{C}$ to 150°C | –2.1 | ± 1.6 | 2.1 | % |
| | $E_{Sens(LIFE)(LT)}$ | $T_A = -40^\circ\text{C}$ to 25°C | –3.5 | ± 2.5 | 3.5 | % |
| Total Output Error Including Lifetime | $E_{TOT(LIFE)(HT)}$ | $T_A = 25^\circ\text{C}$ to 150°C | –2.1 | ± 1.7 | 2.1 | % |
| | $E_{TOT(LIFE)(LT)}$ | $T_A = -40^\circ\text{C}$ to 25°C | –3.5 | ± 2.6 | 3.5 | % |
| Electric Offset Error Including Lifetime | $E_{OFF(LIFE)(HT)}$ | $T_A = 25^\circ\text{C}$ to 150°C | –10 | ± 7 | 10 | mV |
| | $E_{OFF(LIFE)(LT)}$ | $T_A = -40^\circ\text{C}$ to 25°C | –20 | ± 8.9 | 20 | mV |

[1] All ACS772 devices are production tested and guaranteed to $T_A = 150^\circ\text{C}$, provided the Maximum Junction Temperature, $T_{J(\text{MAX})}$, is not exceeded. See Absolute Maximum Ratings and Thermal Application section of this datasheet for more information.

[2] Typical values are ± 3 sigma values.

[3] Min/max limits are derived from AEC-Q100 Grade 1 testing.

X150B PERFORMANCE CHARACTERISTICS: $T_A = -40^\circ\text{C}$ to 150°C [1], $V_{CC} = 5\text{ V}$, unless otherwise specified

| Characteristic | Symbol | Test Conditions | Min. | Typ. [2] | Max. | Unit |
|--|----------------------|---|-------|---------------------------|------|-------------------|
| NOMINAL PERFORMANCE | | | | | | |
| Current Sensing Range | I_{PR} | | -150 | - | 150 | A |
| Sensitivity | Sens | $I_{PR(\min)} < I_P < I_{PR(\max)}$ | - | $13.33 \times V_{CC} / 5$ | - | mV/A |
| Zero Current Output Voltage | $V_{IOUT(Q)}$ | Bidirectional; $I_P = 0\text{ A}$ | - | $V_{CC} / 2$ | - | V |
| ACCURACY PERFORMANCE | | | | | | |
| Noise | V_N | $T_A = 25^\circ\text{C}$, $C_L = 1\text{ nF}$ | - | 7.2 | - | mV _{p-p} |
| | | $T_A = 25^\circ\text{C}$, $C_L = 1\text{ nF}$ | - | 1.2 | - | mV _{RMS} |
| Sensitivity Error | E_{Sens} | Full scale of I_P , $T_A = 25^\circ\text{C}$ | -1 | ± 0.7 | 1 | % |
| | | Full scale of I_P , $T_A = 25^\circ\text{C}$ to 150°C | -1.25 | ± 0.8 | 1.25 | % |
| | | Full scale of I_P , $T_A = -40^\circ\text{C}$ to 25°C | -3.5 | ± 1.7 | 3.5 | % |
| Electrical Offset Error | $V_{OE(TA)}$ | $I_P = 0\text{ A}$, $T_A = 25^\circ\text{C}$ | -8 | ± 4 | 8 | mV |
| | $V_{OE(TA)HT}$ | $I_P = 0\text{ A}$, $T_A = 25^\circ\text{C}$ to 150°C | -8 | ± 4 | 8 | mV |
| | $V_{OE(TA)LT}$ | $I_P = 0\text{ A}$, $T_A = -40^\circ\text{C}$ to 25°C | -20 | ± 6 | 20 | mV |
| Magnetic Offset Error | I_{ERROM} | $I_P = 0\text{ A}$, $T_A = 25^\circ\text{C}$, after excursion of $I_{PR(\max)}$ | - | 280 | 400 | mA |
| Total Output Error | $E_{TOT(HT)}$ | Full scale of I_P , $T_A = 25^\circ\text{C}$ to 150°C | -1.5 | ± 0.9 | 1.5 | % |
| | $E_{TOT(LT)}$ | Full scale of I_P , $T_A = -40^\circ\text{C}$ to 25°C | -3.5 | ± 1.7 | 3.5 | % |
| LIFETIME ACCURACY CHARACTERISTICS [3] | | | | | | |
| Sensitivity Error Including Lifetime | $E_{Sens(LIFE)(HT)}$ | $T_A = 25^\circ\text{C}$ to 150°C | -2.1 | ± 1.6 | 2.1 | % |
| | $E_{Sens(LIFE)(LT)}$ | $T_A = -40^\circ\text{C}$ to 25°C | -3.5 | ± 2.5 | 3.5 | % |
| Total Output Error Including Lifetime | $E_{TOT(LIFE)(HT)}$ | $T_A = 25^\circ\text{C}$ to 150°C | -2.1 | ± 1.7 | 2.1 | % |
| | $E_{TOT(LIFE)(LT)}$ | $T_A = -40^\circ\text{C}$ to 25°C | -3.5 | ± 2.6 | 3.5 | % |
| Electric Offset Error Including Lifetime | $E_{OFF(LIFE)(HT)}$ | $T_A = 25^\circ\text{C}$ to 150°C | -10 | ± 7 | 10 | mV |
| | $E_{OFF(LIFE)(LT)}$ | $T_A = -40^\circ\text{C}$ to 25°C | -20 | ± 8.9 | 20 | mV |

[1] All ACS772 devices are production tested and guaranteed to $T_A = 150^\circ\text{C}$, provided the Maximum Junction Temperature, $T_{J(\text{MAX})}$, is not exceeded. See Absolute Maximum Ratings and Thermal Application section of this datasheet for more information.

[2] Typical values are ± 3 sigma values.

[3] Min/max limits are derived from AEC-Q100 Grade 1 testing.

X200U PERFORMANCE CHARACTERISTICS: $T_A = -40^\circ\text{C}$ to 150°C [1], $V_{CC} = 5\text{ V}$, unless otherwise specified

| Characteristic | Symbol | Test Conditions | Min. | Typ. [2] | Max. | Unit |
|--|----------------------|---|-------|------------------------|------|-------------------|
| NOMINAL PERFORMANCE | | | | | | |
| Current Sensing Range | I_{PR} | | 0 | – | 200 | A |
| Sensitivity | Sens | $I_{PR(\min)} < I_P < I_{PR(\max)}$ | – | $20 \times V_{CC} / 5$ | – | mV/A |
| Zero Current Output Voltage | $V_{IOUT(Q)}$ | Unidirectional; $I_P = 0\text{ A}$ | – | $V_{CC} / 10$ | – | V |
| ACCURACY PERFORMANCE | | | | | | |
| Noise | V_N | $T_A = 25^\circ\text{C}$, $C_L = 1\text{ nF}$ | – | 7.2 | – | mV _{p-p} |
| | | $T_A = 25^\circ\text{C}$, $C_L = 1\text{ nF}$ | – | 1.2 | – | mV _{RMS} |
| Sensitivity Error | E_{Sens} | Full scale of I_P , $T_A = 25^\circ\text{C}$ | –1 | ± 0.5 | 1 | % |
| | | Full scale of I_P , $T_A = 25^\circ\text{C}$ to 150°C | –1.25 | ± 0.7 | 1.25 | % |
| | | Full scale of I_P , $T_A = -40^\circ\text{C}$ to 25°C | –3.5 | ± 1.5 | 3.5 | % |
| Electrical Offset Error | $V_{OE(TA)}$ | $I_P = 0\text{ A}$, $T_A = 25^\circ\text{C}$ | –8 | ± 4 | 8 | mV |
| | $V_{OE(TA)HT}$ | $I_P = 0\text{ A}$, $T_A = 25^\circ\text{C}$ to 150°C | –20 | ± 6 | 20 | mV |
| | $V_{OE(TA)LT}$ | $I_P = 0\text{ A}$, $T_A = -40^\circ\text{C}$ to 25°C | –20 | ± 6 | 20 | mV |
| Magnetic Offset Error | I_{ERROM} | $I_P = 0\text{ A}$, $T_A = 25^\circ\text{C}$, after excursion of $I_{PR(\max)}$ | – | 160 | 400 | mA |
| Total Output Error | $E_{TOT(HT)}$ | Full scale of I_P , $T_A = 25^\circ\text{C}$ to 150°C | –1.5 | ± 0.9 | 1.5 | % |
| | $E_{TOT(LT)}$ | Full scale of I_P , $T_A = -40^\circ\text{C}$ to 25°C | –3.5 | ± 1.7 | 3.5 | % |
| LIFETIME ACCURACY CHARACTERISTICS [3] | | | | | | |
| Sensitivity Error Including Lifetime | $E_{Sens(LIFE)(HT)}$ | $T_A = 25^\circ\text{C}$ to 150°C | –2.1 | ± 1.6 | 2.1 | % |
| | $E_{Sens(LIFE)(LT)}$ | $T_A = -40^\circ\text{C}$ to 25°C | –3.5 | ± 2.5 | 3.5 | % |
| Total Output Error Including Lifetime | $E_{TOT(LIFE)(HT)}$ | $T_A = 25^\circ\text{C}$ to 150°C | –2.1 | ± 1.7 | 2.1 | % |
| | $E_{TOT(LIFE)(LT)}$ | $T_A = -40^\circ\text{C}$ to 25°C | –3.5 | ± 2.6 | 3.5 | % |
| Electric Offset Error Including Lifetime | $E_{OFF(LIFE)(HT)}$ | $T_A = 25^\circ\text{C}$ to 150°C | –10 | ± 7 | 10 | mV |
| | $E_{OFF(LIFE)(LT)}$ | $T_A = -40^\circ\text{C}$ to 25°C | –20 | ± 8.9 | 20 | mV |

[1] All ACS772 devices are production tested and guaranteed to $T_A = 150^\circ\text{C}$, provided the Maximum Junction Temperature, $T_{J(\text{MAX})}$, is not exceeded. See Absolute Maximum Ratings and Thermal Application section of this datasheet for more information.

[2] Typical values are ± 3 sigma values.

[3] Min/max limits are derived from AEC-Q100 Grade 1 testing.

X200B PERFORMANCE CHARACTERISTICS: $T_A = -40^\circ\text{C}$ to 150°C [1], $V_{CC} = 5\text{ V}$, unless otherwise specified

| Characteristic | Symbol | Test Conditions | Min. | Typ. [2] | Max. | Unit |
|--|----------------------|---|-------|------------------------|------|-------------------|
| NOMINAL PERFORMANCE | | | | | | |
| Current Sensing Range | I_{PR} | | -200 | - | 200 | A |
| Sensitivity | Sens | $I_{PR(\min)} < I_P < I_{PR(\max)}$ | - | $10 \times V_{CC} / 5$ | - | mV/A |
| Zero Current Output Voltage | $V_{IOUT(Q)}$ | Bidirectional; $I_P = 0\text{ A}$ | - | $V_{CC} / 2$ | - | V |
| ACCURACY PERFORMANCE | | | | | | |
| Noise | V_N | $T_A = 25^\circ\text{C}$, $C_L = 1\text{ nF}$ | - | 5.1 | - | mV _{p-p} |
| | | $T_A = 25^\circ\text{C}$, $C_L = 1\text{ nF}$ | - | 0.85 | - | mV _{RMS} |
| Sensitivity Error | E_{Sens} | Full scale of I_P , $T_A = 25^\circ\text{C}$ | -1 | ± 0.5 | 1 | % |
| | | Full scale of I_P , $T_A = 25^\circ\text{C}$ to 150°C | -1.25 | ± 0.7 | 1.25 | % |
| | | Full scale of I_P , $T_A = -40^\circ\text{C}$ to 25°C | -3.5 | ± 1.5 | 3.5 | % |
| Electrical Offset Error | $V_{OE(TA)}$ | $I_P = 0\text{ A}$, $T_A = 25^\circ\text{C}$ | -8 | ± 4 | 8 | mV |
| | $V_{OE(TA)HT}$ | $I_P = 0\text{ A}$, $T_A = 25^\circ\text{C}$ to 150°C | -8 | ± 4 | 8 | mV |
| | $V_{OE(TA)LT}$ | $I_P = 0\text{ A}$, $T_A = -40^\circ\text{C}$ to 25°C | -20 | ± 6 | 20 | mV |
| Magnetic Offset Error | I_{ERROM} | $I_P = 0\text{ A}$, $T_A = 25^\circ\text{C}$, after excursion of $I_{PR(\max)}$ | - | 380 | 400 | mA |
| Total Output Error | $E_{TOT(HT)}$ | Full scale of I_P , $T_A = 25^\circ\text{C}$ to 150°C | -1.5 | ± 0.7 | 1.5 | % |
| | $E_{TOT(LT)}$ | Full scale of I_P , $T_A = -40^\circ\text{C}$ to 25°C | -3.5 | ± 1.5 | 3.5 | % |
| LIFETIME ACCURACY CHARACTERISTICS [3] | | | | | | |
| Sensitivity Error Including Lifetime | $E_{Sens(LIFE)(HT)}$ | $T_A = 25^\circ\text{C}$ to 150°C | -2.1 | ± 1.6 | 2.1 | % |
| | $E_{Sens(LIFE)(LT)}$ | $T_A = -40^\circ\text{C}$ to 25°C | -3.5 | ± 2.5 | 3.5 | % |
| Total Output Error Including Lifetime | $E_{TOT(LIFE)(HT)}$ | $T_A = 25^\circ\text{C}$ to 150°C | -2.1 | ± 1.7 | 2.1 | % |
| | $E_{TOT(LIFE)(LT)}$ | $T_A = -40^\circ\text{C}$ to 25°C | -3.5 | ± 2.6 | 3.5 | % |
| Electric Offset Error Including Lifetime | $E_{OFF(LIFE)(HT)}$ | $T_A = 25^\circ\text{C}$ to 150°C | -10 | ± 7 | 10 | mV |
| | $E_{OFF(LIFE)(LT)}$ | $T_A = -40^\circ\text{C}$ to 25°C | -20 | ± 8.9 | 20 | mV |

[1] All ACS772 devices are production tested and guaranteed to $T_A = 150^\circ\text{C}$, provided the Maximum Junction Temperature, $T_{J(\text{MAX})}$, is not exceeded. See Absolute Maximum Ratings and Thermal Application section of this datasheet for more information.

[2] Typical values are ± 3 sigma values.

[3] Min/max limits are derived from AEC-Q100 Grade 1 testing.

X250U PERFORMANCE CHARACTERISTICS: $T_A = -40^\circ\text{C}$ to 150°C [1], $V_{CC} = 5\text{ V}$, unless otherwise specified

| Characteristic | Symbol | Test Conditions | Min. | Typ. [2] | Max. | Unit |
|--|----------------------|---|-------|------------------------|------|-------------------|
| NOMINAL PERFORMANCE | | | | | | |
| Current Sensing Range | I_{PR} | | 0 | – | 250 | A |
| Sensitivity | Sens | $I_{PR(\min)} < I_P < I_{PR(\max)}$ | – | $16 \times V_{CC} / 5$ | – | mV/A |
| Zero Current Output Voltage | $V_{IOUT(Q)}$ | Unidirectional; $I_P = 0\text{ A}$ | – | $V_{CC} / 10$ | – | V |
| ACCURACY PERFORMANCE | | | | | | |
| Noise | V_N | $T_A = 25^\circ\text{C}$, $C_L = 1\text{ nF}$ | – | 5.1 | – | mV _{p-p} |
| | | $T_A = 25^\circ\text{C}$, $C_L = 1\text{ nF}$ | – | 0.85 | – | mV _{RMS} |
| Sensitivity Error | E_{Sens} | $I_P = 200\text{ A}$, not tested at full scale I_P ; $T_A = 25^\circ\text{C}$ | –1 | ± 0.7 | 1 | % |
| | | $I_P = 200\text{ A}$, not tested at full scale I_P ; $T_A = 25^\circ\text{C}$ to 150°C | –1.25 | ± 0.8 | 1.25 | % |
| | | $I_P = 200\text{ A}$, not tested at full scale I_P ; $T_A = -40^\circ\text{C}$ to 25°C | –3.5 | ± 1.7 | 3.5 | % |
| Electrical Offset Error | $V_{OE(TA)}$ | $I_P = 0\text{ A}$, $T_A = 25^\circ\text{C}$ | –8 | ± 4 | 8 | mV |
| | $V_{OE(TA)HT}$ | $I_P = 0\text{ A}$, $T_A = 25^\circ\text{C}$ to 150°C | –8 | ± 4 | 8 | mV |
| | $V_{OE(TA)LT}$ | $I_P = 0\text{ A}$, $T_A = -40^\circ\text{C}$ to 25°C | –20 | ± 6 | 20 | mV |
| Magnetic Offset Error | I_{ERROM} | $I_P = 0\text{ A}$, $T_A = 25^\circ\text{C}$, after excursion of $I_{PR(\max)}$ | – | 200 | 400 | mA |
| Total Output Error | $E_{TOT(HT)}$ | $I_P = 200\text{ A}$, not tested at full scale I_P ; $T_A = 25^\circ\text{C}$ to 150°C | –1.5 | ± 0.9 | 1.5 | % |
| | $E_{TOT(LT)}$ | $I_P = 200\text{ A}$, not tested at full scale I_P ; $T_A = -40^\circ\text{C}$ to 25°C | –3.5 | ± 1.7 | 3.5 | % |
| LIFETIME ACCURACY CHARACTERISTICS [3] | | | | | | |
| Sensitivity Error Including Lifetime | $E_{Sens(LIFE)(HT)}$ | $T_A = 25^\circ\text{C}$ to 150°C | –2.1 | ± 1.6 | 2.1 | % |
| | $E_{Sens(LIFE)(LT)}$ | $T_A = -40^\circ\text{C}$ to 25°C | –3.5 | ± 2.5 | 3.5 | % |
| Total Output Error Including Lifetime | $E_{TOT(LIFE)(HT)}$ | $T_A = 25^\circ\text{C}$ to 150°C | –2.1 | ± 1.7 | 2.1 | % |
| | $E_{TOT(LIFE)(LT)}$ | $T_A = -40^\circ\text{C}$ to 25°C | –3.5 | ± 2.6 | 3.5 | % |
| Electric Offset Error Including Lifetime | $E_{OFF(LIFE)(HT)}$ | $T_A = 25^\circ\text{C}$ to 150°C | –10 | ± 7 | 10 | mV |
| | $E_{OFF(LIFE)(LT)}$ | $T_A = -40^\circ\text{C}$ to 25°C | –20 | ± 8.9 | 20 | mV |

[1] All ACS772 devices are production tested and guaranteed to $T_A = 150^\circ\text{C}$, provided the Maximum Junction Temperature, $T_{J(\max)}$, is not exceeded. See Absolute Maximum Ratings and Thermal Application section of this datasheet for more information.

[2] Typical values are ± 3 sigma values.

[3] Min/max limits are derived from AEC-Q100 Grade 1 testing.

X250B PERFORMANCE CHARACTERISTICS: $T_A = -40^\circ\text{C}$ to 150°C [1], $V_{CC} = 5\text{ V}$, unless otherwise specified

| Characteristic | Symbol | Test Conditions | Min. | Typ. [2] | Max. | Unit |
|--|----------------------|---|-------|-----------------------------|------|-------------------|
| NOMINAL PERFORMANCE | | | | | | |
| Current Sensing Range | I_{PR} | | -250 | - | 250 | A |
| Sensitivity | Sens | $I_{PR(\min)} < I_P < I_{PR(\max)}$ | - | $\frac{8 \times V_{CC}}{5}$ | - | mV/A |
| Zero Current Output Voltage | $V_{IOUT(Q)}$ | Bidirectional; $I_P = 0\text{ A}$ | - | $V_{CC} / 2$ | - | V |
| ACCURACY PERFORMANCE | | | | | | |
| Noise | V_N | $T_A = 25^\circ\text{C}$, $C_L = 1\text{ nF}$ | - | 5.1 | - | mV _{p-p} |
| | | $T_A = 25^\circ\text{C}$, $C_L = 1\text{ nF}$ | - | 0.85 | - | mV _{RMS} |
| Sensitivity Error | E_{Sens} | $I_P = 200\text{ A}$, not tested at full scale I_P ; $T_A = 25^\circ\text{C}$ | -1 | ± 0.7 | 1 | % |
| | | $I_P = 200\text{ A}$, not tested at full scale I_P ; $T_A = 25^\circ\text{C}$ to 150°C | -1.25 | ± 0.8 | 1.25 | % |
| | | $I_P = 200\text{ A}$, not tested at full scale I_P ; $T_A = -40^\circ\text{C}$ to 25°C | -3.5 | ± 1.7 | 3.5 | % |
| Electrical Offset Error | $V_{OE(TA)}$ | $I_P = 0\text{ A}$, $T_A = 25^\circ\text{C}$ | -8 | ± 4 | 8 | mV |
| | $V_{OE(TA)HT}$ | $I_P = 0\text{ A}$, $T_A = 25^\circ\text{C}$ to 150°C | -8 | ± 4 | 8 | mV |
| | $V_{OE(TA)LT}$ | $I_P = 0\text{ A}$, $T_A = -40^\circ\text{C}$ to 25°C | -20 | ± 6 | 20 | mV |
| Magnetic Offset Error | I_{ERROM} | $I_P = 0\text{ A}$, $T_A = 25^\circ\text{C}$, after excursion of $I_{PR(\max)}$ | - | 175 | 400 | mA |
| Total Output Error | $E_{TOT(HT)}$ | $I_P = 200\text{ A}$, not tested at full scale I_P ; $T_A = 25^\circ\text{C}$ to 150°C | -1.5 | ± 0.9 | 1.5 | % |
| | $E_{TOT(LT)}$ | $I_P = 200\text{ A}$, not tested at full scale I_P ; $T_A = -40^\circ\text{C}$ to 25°C | -3.5 | ± 1.7 | 3.5 | % |
| LIFETIME ACCURACY CHARACTERISTICS [3] | | | | | | |
| Sensitivity Error Including Lifetime | $E_{Sens(LIFE)(HT)}$ | $T_A = 25^\circ\text{C}$ to 150°C | -2.1 | ± 1.6 | 2.1 | % |
| | $E_{Sens(LIFE)(LT)}$ | $T_A = -40^\circ\text{C}$ to 25°C | -3.5 | ± 2.5 | 3.5 | % |
| Total Output Error Including Lifetime | $E_{TOT(LIFE)(HT)}$ | $T_A = 25^\circ\text{C}$ to 150°C | -2.1 | ± 1.7 | 2.1 | % |
| | $E_{TOT(LIFE)(LT)}$ | $T_A = -40^\circ\text{C}$ to 25°C | -3.5 | ± 2.6 | 3.5 | % |
| Electric Offset Error Including Lifetime | $E_{OFF(LIFE)(HT)}$ | $T_A = 25^\circ\text{C}$ to 150°C | -10 | ± 7 | 10 | mV |
| | $E_{OFF(LIFE)(LT)}$ | $T_A = -40^\circ\text{C}$ to 25°C | -20 | ± 8.9 | 20 | mV |

[1] All ACS772 devices are production tested and guaranteed to $T_A = 150^\circ\text{C}$, provided the Maximum Junction Temperature, $T_{J(\max)}$, is not exceeded. See Absolute Maximum Ratings and Thermal Application section of this datasheet for more information.

[2] Typical values are ± 3 sigma values.

[3] Min/max limits are derived from AEC-Q100 Grade 1 testing.

X300B PERFORMANCE CHARACTERISTICS: $T_A = -40^\circ\text{C}$ to 150°C [1], $V_{CC} = 5\text{ V}$, unless otherwise specified

| Characteristic | Symbol | Test Conditions | Min. | Typ. [2] | Max. | Unit |
|--|----------------------|---|-------|--------------------------|------|-------------------|
| NOMINAL PERFORMANCE | | | | | | |
| Current Sensing Range | I_{PR} | | -300 | - | 300 | A |
| Sensitivity | Sens | $I_{PR(\min)} < I_P < I_{PR(\max)}$ | - | $6.66 \times V_{CC} / 5$ | - | mV/A |
| Zero Current Output Voltage | $V_{IOUT(Q)}$ | Bidirectional; $I_P = 0\text{ A}$ | - | $V_{CC} / 2$ | - | V |
| ACCURACY PERFORMANCE | | | | | | |
| Noise | V_N | $T_A = 25^\circ\text{C}$, $C_L = 1\text{ nF}$ | - | 5.1 | - | mV _{p-p} |
| | | $T_A = 25^\circ\text{C}$, $C_L = 1\text{ nF}$ | - | 0.85 | - | mV _{RMS} |
| Sensitivity Error | E_{Sens} | $I_P = 200\text{ A}$, not tested at full scale I_P ; $T_A = 25^\circ\text{C}$ | -1 | ± 0.7 | 1 | % |
| | | $I_P = 200\text{ A}$, not tested at full scale I_P ; $T_A = 25^\circ\text{C}$ to 150°C | -1.25 | ± 0.8 | 1.25 | % |
| | | $I_P = 200\text{ A}$, not tested at full scale I_P ; $T_A = -40^\circ\text{C}$ to 25°C | -3.5 | ± 1.7 | 3.5 | % |
| Electrical Offset Error | $V_{OE(TA)}$ | $I_P = 0\text{ A}$, $T_A = 25^\circ\text{C}$ | -8 | ± 4 | 8 | mV |
| | $V_{OE(TA)HT}$ | $I_P = 0\text{ A}$, $T_A = 25^\circ\text{C}$ to 150°C | -8 | ± 4 | 8 | mV |
| | $V_{OE(TA)LT}$ | $I_P = 0\text{ A}$, $T_A = -40^\circ\text{C}$ to 25°C | -20 | ± 6 | 20 | mV |
| Magnetic Offset Error | I_{ERROM} | $I_P = 0\text{ A}$, $T_A = 25^\circ\text{C}$, after excursion of $I_{PR(\max)}$ | - | 175 | 400 | mA |
| Total Output Error | $E_{TOT(HT)}$ | $I_P = 200\text{ A}$, not tested at full scale I_P ; $T_A = 25^\circ\text{C}$ to 150°C | -1.5 | ± 0.9 | 1.5 | % |
| | $E_{TOT(LT)}$ | $I_P = 200\text{ A}$, not tested at full scale I_P ; $T_A = -40^\circ\text{C}$ to 25°C | -3.5 | ± 1.7 | 3.5 | % |
| LIFETIME ACCURACY CHARACTERISTICS [3] | | | | | | |
| Sensitivity Error Including Lifetime | $E_{Sens(LIFE)(HT)}$ | $T_A = 25^\circ\text{C}$ to 150°C | -2.1 | ± 1.6 | 2.1 | % |
| | $E_{Sens(LIFE)(LT)}$ | $T_A = -40^\circ\text{C}$ to 25°C | -3.5 | ± 2.5 | 3.5 | % |
| Total Output Error Including Lifetime | $E_{TOT(LIFE)(HT)}$ | $T_A = 25^\circ\text{C}$ to 150°C | -2.1 | ± 1.7 | 2.1 | % |
| | $E_{TOT(LIFE)(LT)}$ | $T_A = -40^\circ\text{C}$ to 25°C | -3.5 | ± 2.6 | 3.5 | % |
| Electric Offset Error Including Lifetime | $E_{OFF(LIFE)(HT)}$ | $T_A = 25^\circ\text{C}$ to 150°C | -10 | ± 7 | 10 | mV |
| | $E_{OFF(LIFE)(LT)}$ | $T_A = -40^\circ\text{C}$ to 25°C | -20 | ± 8.9 | 20 | mV |

[1] All ACS772 devices are production tested and guaranteed to $T_A = 150^\circ\text{C}$, provided the Maximum Junction Temperature, $T_{J(\max)}$, is not exceeded. See Absolute Maximum Ratings and Thermal Application section of this datasheet for more information.

[2] Typical values are ± 3 sigma values.

[3] Min/max limits are derived from AEC-Q100 Grade 1 testing.

X400B PERFORMANCE CHARACTERISTICS: $T_A = -40^\circ\text{C}$ to 150°C [1], $V_{CC} = 5\text{ V}$, unless otherwise specified

| Characteristic | Symbol | Test Conditions | Min. | Typ. [2] | Max. | Unit |
|--|----------------------|---|-------|-----------------------|------|-------------------|
| NOMINAL PERFORMANCE | | | | | | |
| Current Sensing Range | I_{PR} | | -400 | - | 400 | A |
| Sensitivity | Sens | $I_{PR(\min)} < I_P < I_{PR(\max)}$ | - | $5 \times V_{CC} / 5$ | - | mV/A |
| Zero Current Output Voltage | $V_{IOUT(Q)}$ | Bidirectional; $I_P = 0\text{ A}$ | - | $V_{CC} / 2$ | - | V |
| ACCURACY PERFORMANCE | | | | | | |
| Noise | V_N | $T_A = 25^\circ\text{C}$, $C_L = 1\text{ nF}$ | - | 5.1 | - | mV _{p-p} |
| | | $T_A = 25^\circ\text{C}$, $C_L = 1\text{ nF}$ | - | 0.85 | - | mV _{RMS} |
| Sensitivity Error | E_{Sens} | $I_P = 200\text{ A}$, not tested at full scale I_P ; $T_A = 25^\circ\text{C}$ | -1 | ± 0.7 | 1 | % |
| | | $I_P = 200\text{ A}$, not tested at full scale I_P ; $T_A = 25^\circ\text{C}$ to 150°C | -1.25 | ± 0.8 | 1.25 | % |
| | | $I_P = 200\text{ A}$, not tested at full scale I_P ; $T_A = -40^\circ\text{C}$ to 25°C | -3.5 | ± 1.7 | 3.5 | % |
| Electrical Offset Error | $V_{OE(TA)}$ | $I_P = 0\text{ A}$, $T_A = 25^\circ\text{C}$ | -8 | ± 4 | 8 | mV |
| | $V_{OE(TA)HT}$ | $I_P = 0\text{ A}$, $T_A = 25^\circ\text{C}$ to 150°C | -8 | ± 4 | 8 | mV |
| | $V_{OE(TA)LT}$ | $I_P = 0\text{ A}$, $T_A = -40^\circ\text{C}$ to 25°C | -20 | ± 6 | 20 | mV |
| Magnetic Offset Error | I_{ERRM} | $I_P = 0\text{ A}$, $T_A = 25^\circ\text{C}$, after excursion of $I_{PR(\max)}$ | - | 175 | 400 | mA |
| Total Output Error | $E_{TOT(HT)}$ | $I_P = 200\text{ A}$, not tested at full scale I_P ; $T_A = 25^\circ\text{C}$ to 150°C | -1.5 | ± 0.9 | 1.5 | % |
| | $E_{TOT(LT)}$ | $I_P = 200\text{ A}$, not tested at full scale I_P ; $T_A = -40^\circ\text{C}$ to 25°C | -3.5 | ± 1.7 | 3.5 | % |
| LIFETIME ACCURACY CHARACTERISTICS [3] | | | | | | |
| Sensitivity Error Including Lifetime | $E_{Sens(LIFE)(HT)}$ | $T_A = 25^\circ\text{C}$ to 150°C | -2.1 | ± 1.6 | 2.1 | % |
| | $E_{Sens(LIFE)(LT)}$ | $T_A = -40^\circ\text{C}$ to 25°C | -3.5 | ± 2.5 | 3.5 | % |
| Total Output Error Including Lifetime | $E_{TOT(LIFE)(HT)}$ | $T_A = 25^\circ\text{C}$ to 150°C | -2.1 | ± 1.7 | 2.1 | % |
| | $E_{TOT(LIFE)(LT)}$ | $T_A = -40^\circ\text{C}$ to 25°C | -3.5 | ± 2.6 | 3.5 | % |
| Electric Offset Error Including Lifetime | $E_{OFF(LIFE)(HT)}$ | $T_A = 25^\circ\text{C}$ to 150°C | -10 | ± 7 | 10 | mV |
| | $E_{OFF(LIFE)(LT)}$ | $T_A = -40^\circ\text{C}$ to 25°C | -20 | ± 8.9 | 20 | mV |

[1] All ACS772 devices are production tested and guaranteed to $T_A = 150^\circ\text{C}$, provided the Maximum Junction Temperature, $T_{J(\max)}$, is not exceeded. See Absolute Maximum Ratings and Thermal Application section of this datasheet for more information.

[2] Typical values are ± 3 sigma values.

[3] Min/max limits are derived from AEC-Q100 Grade 1 testing.

CHARACTERISTIC PERFORMANCE DATA

ACS772LCB-050U-PFF-T

Electrical Offset Voltage versus Ambient Temperature

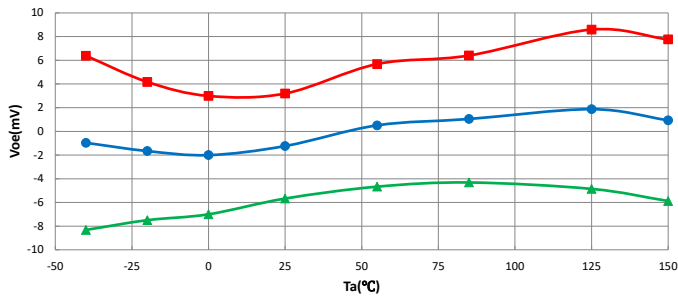

Sensitivity versus Ambient Temperature

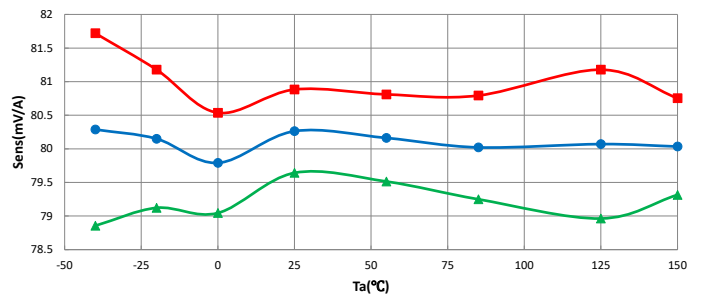

Nonlinearity versus Ambient Temperature

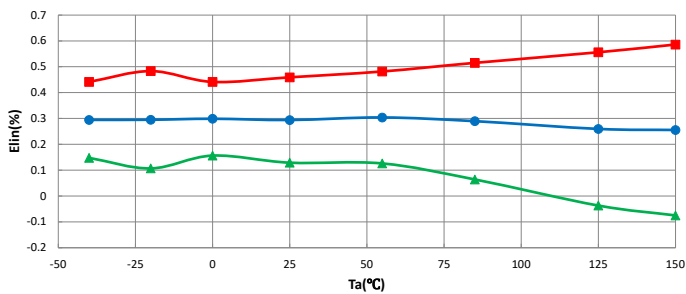

Total Output Error versus Ambient Temperature

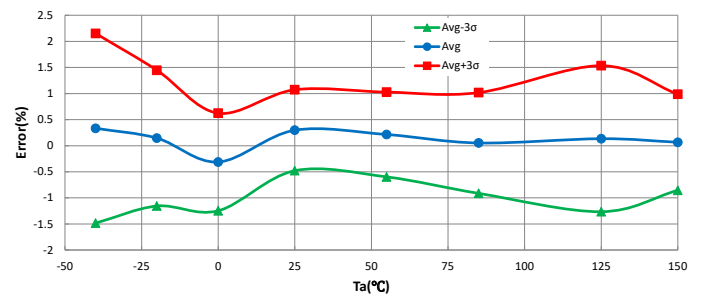

Magnetic Offset Error versus Ambient Temperature

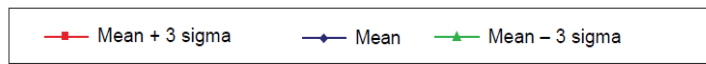
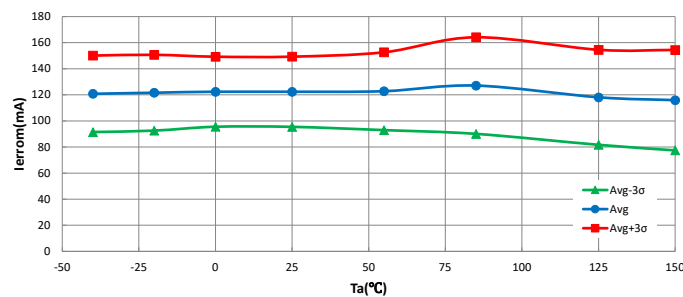

CHARACTERISTIC PERFORMANCE DATA

ACS772LCB-050B-PFF-T

Electrical Offset Voltage versus Ambient Temperature

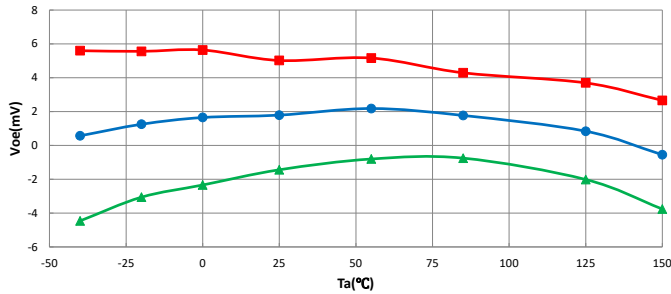

Sensitivity versus Ambient Temperature

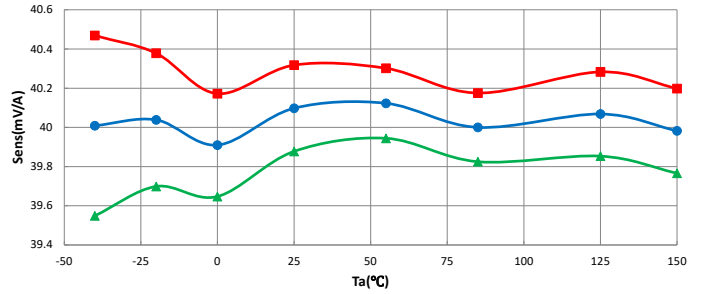

Nonlinearity versus Ambient Temperature

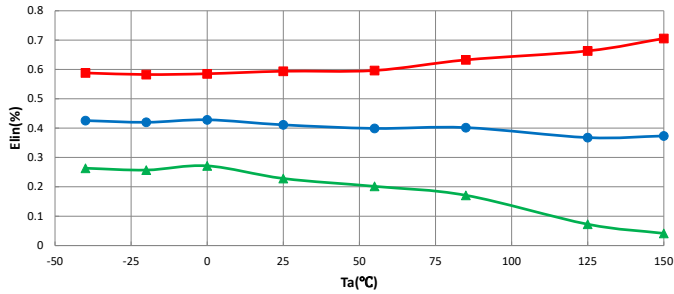

Total Output Error versus Ambient Temperature

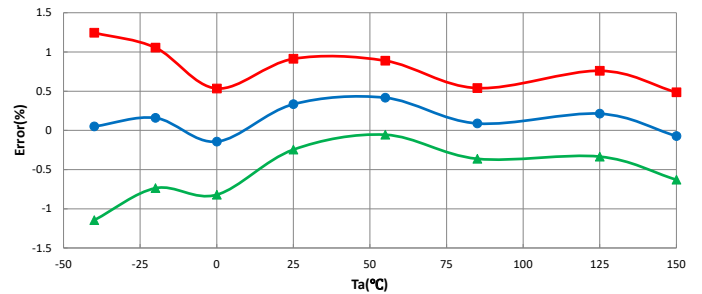

Magnetic Offset Error versus Ambient Temperature

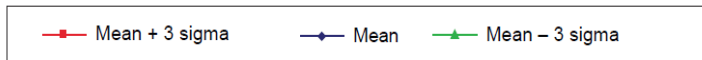
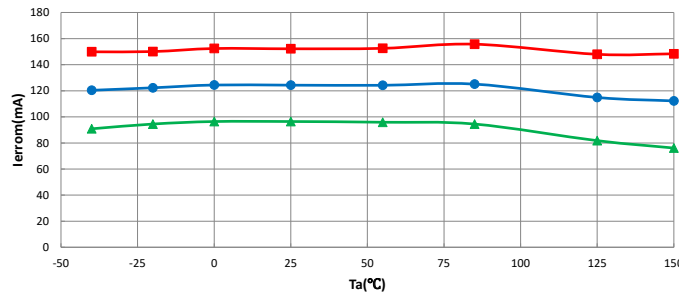

CHARACTERISTIC PERFORMANCE DATA

ACS772LCB-100U-PFF-T

Electrical Offset Voltage versus Ambient Temperature

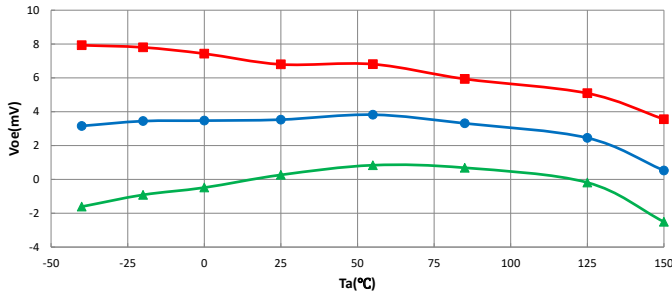

Sensitivity versus Ambient Temperature

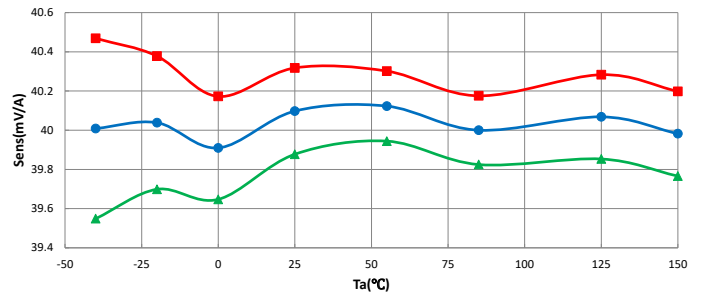

Nonlinearity versus Ambient Temperature

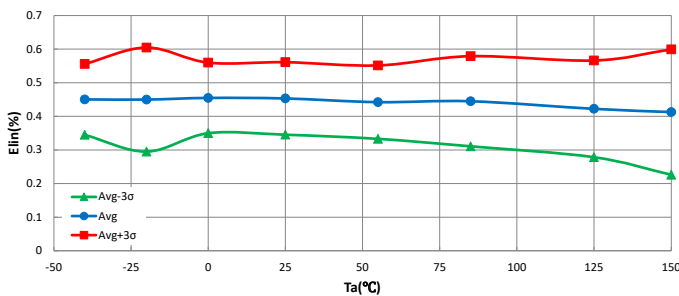

Total Output Error versus Ambient Temperature

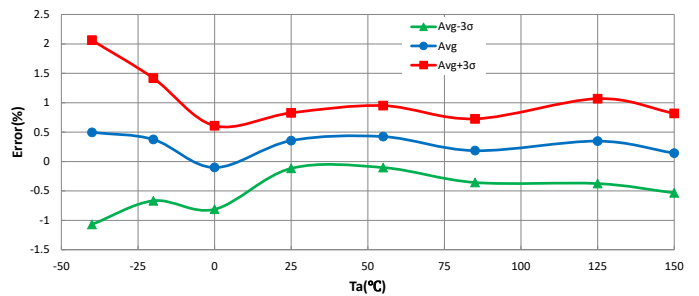

Magnetic Offset Error versus Ambient Temperature

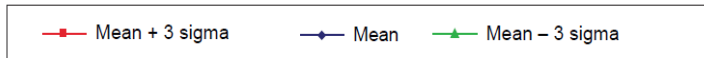
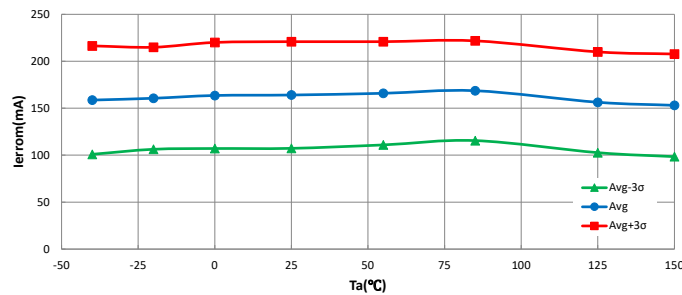

CHARACTERISTIC PERFORMANCE DATA ACS772LCB-100B-PFF-T

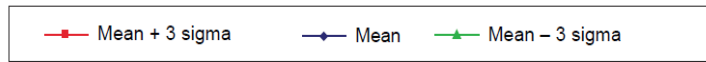
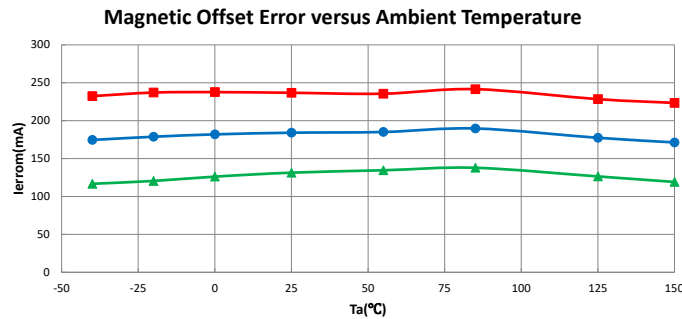
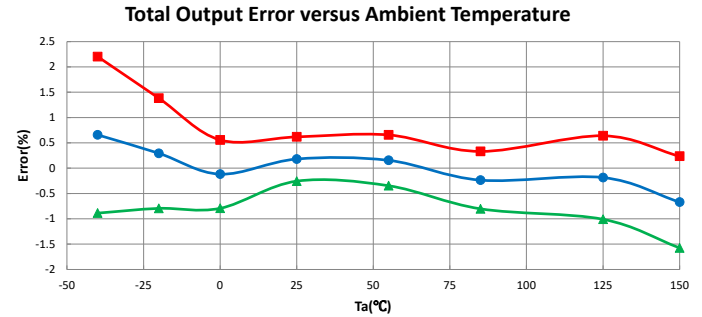
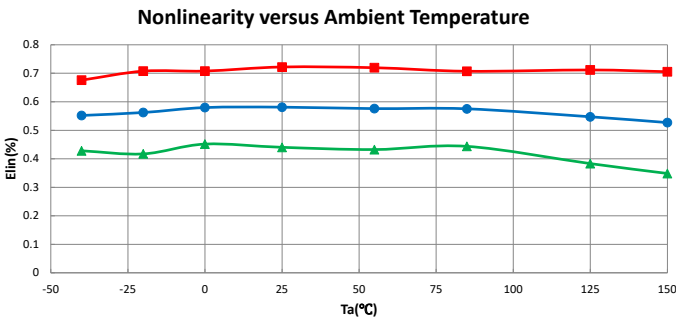
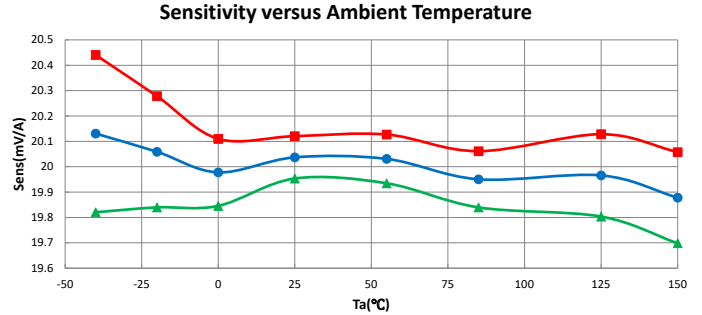
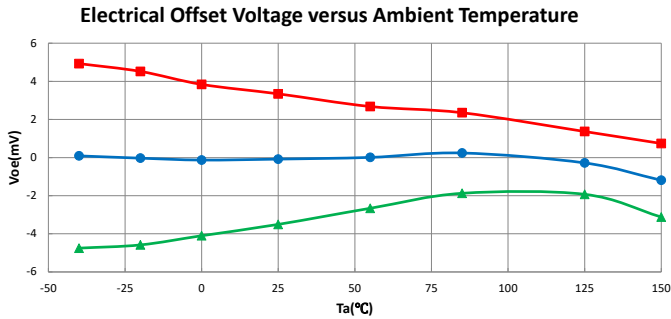

CHARACTERISTIC PERFORMANCE DATA

ACS772KCB-150U-PFF-T

Electrical Offset Voltage versus Ambient Temperature

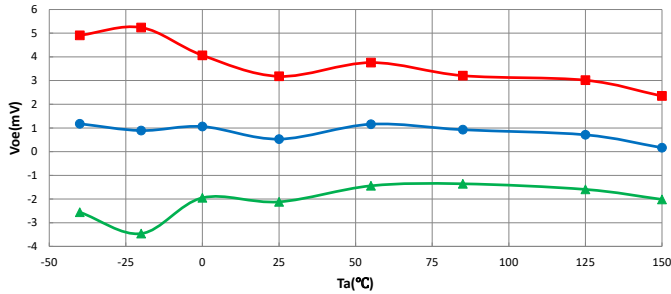

Sensitivity versus Ambient Temperature

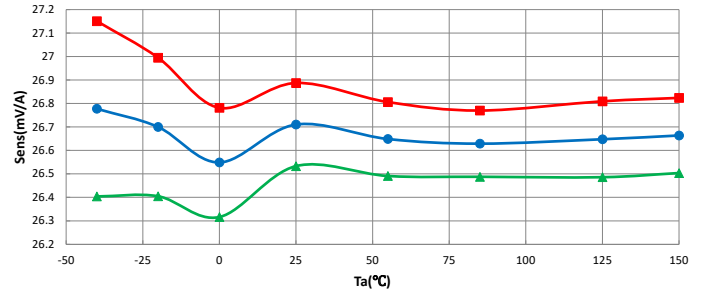

Nonlinearity versus Ambient Temperature

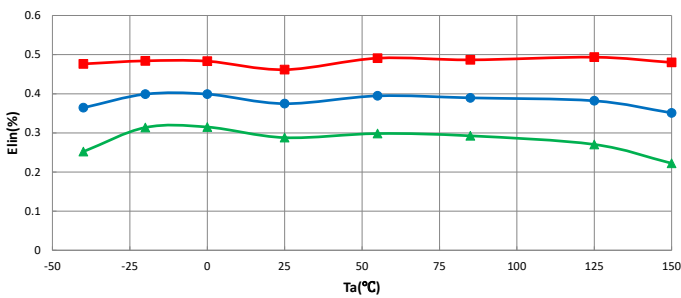

Total Output Error versus Ambient Temperature

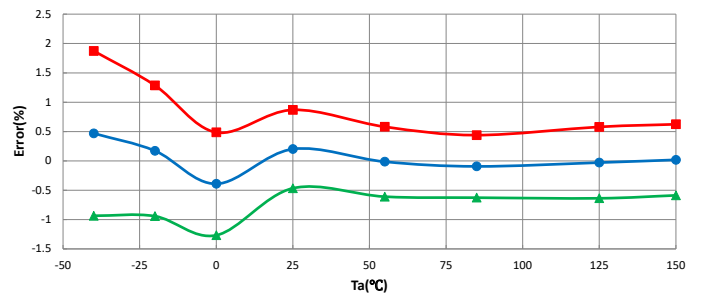

Magnetic Offset Error versus Ambient Temperature

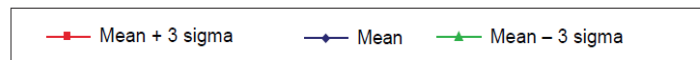
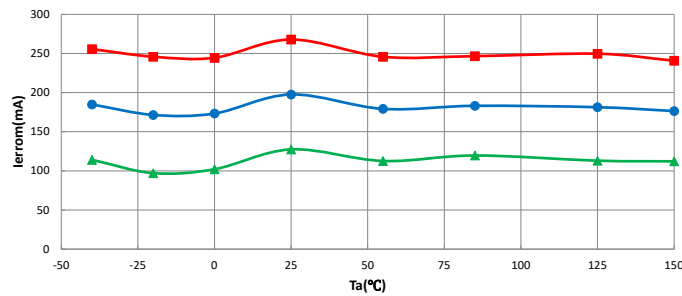

CHARACTERISTIC PERFORMANCE DATA

ACS772KCB-150B-PFF-T

Electrical Offset Voltage versus Ambient Temperature

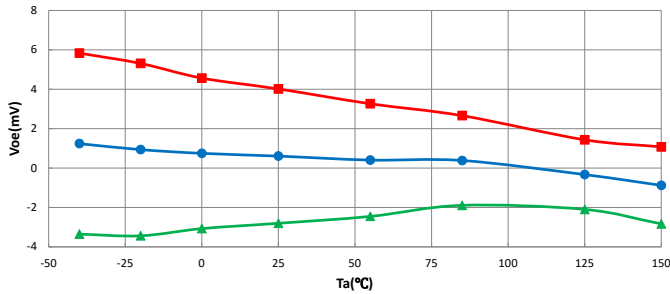

Sensitivity versus Ambient Temperature

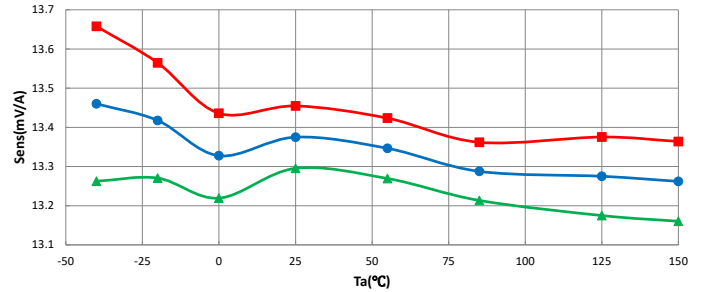

Nonlinearity versus Ambient Temperature

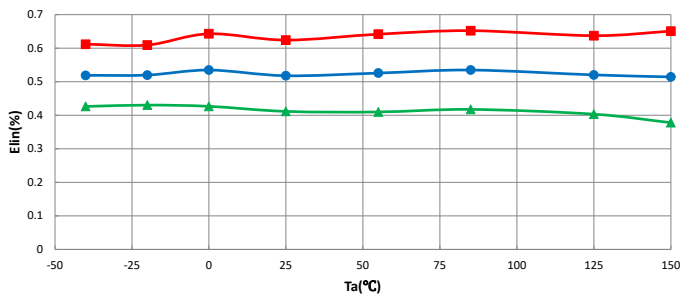

Total Output Error versus Ambient Temperature

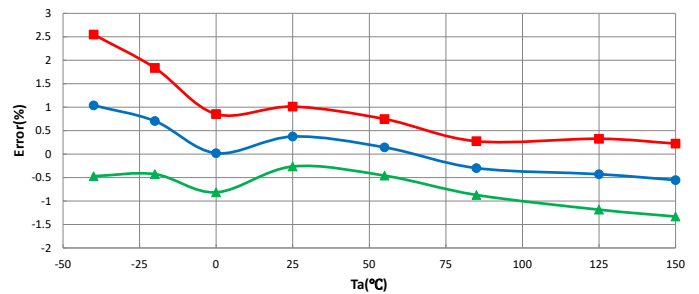

Magnetic Offset Error versus Ambient Temperature

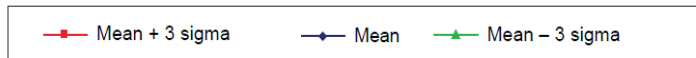
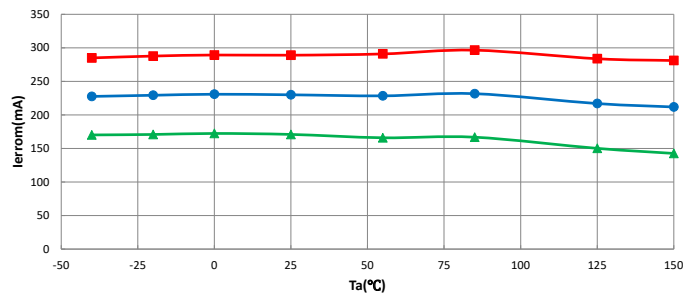

CHARACTERISTIC PERFORMANCE DATA

ACS772ECB-200U-PFF-T

Electrical Offset Voltage versus Ambient Temperature

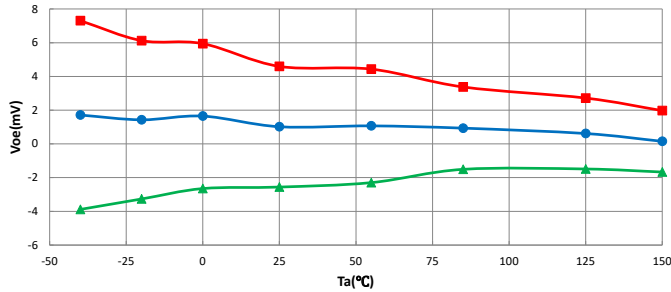

Sensitivity versus Ambient Temperature

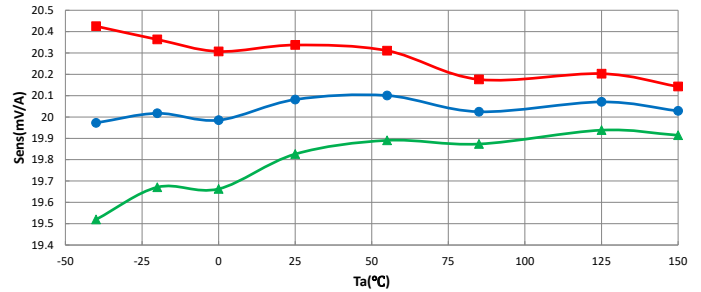

Nonlinearity versus Ambient Temperature

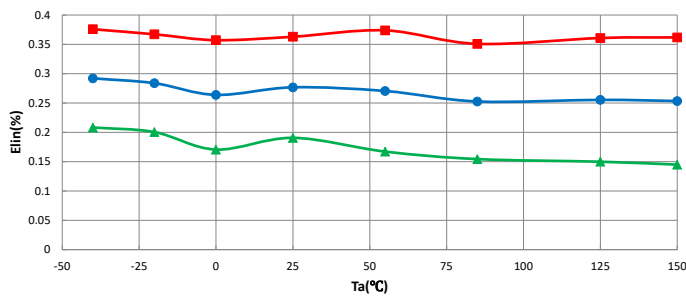

Total Output Error versus Ambient Temperature

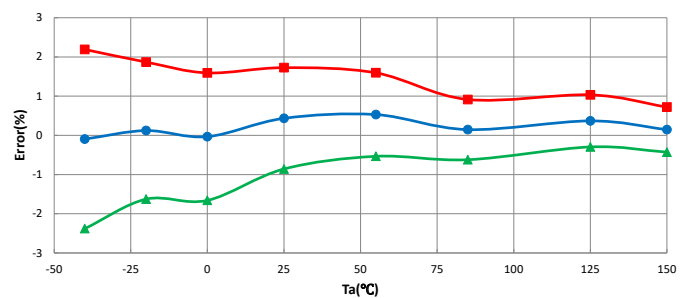

Magnetic Offset Error versus Ambient Temperature

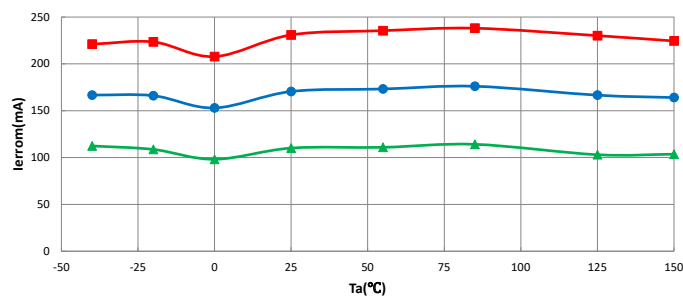

■ Mean + 3 sigma
 ● Mean
 ▲ Mean - 3 sigma

CHARACTERISTIC PERFORMANCE DATA

ACS772ECB-200B-PFF-T

Electrical Offset Voltage versus Ambient Temperature

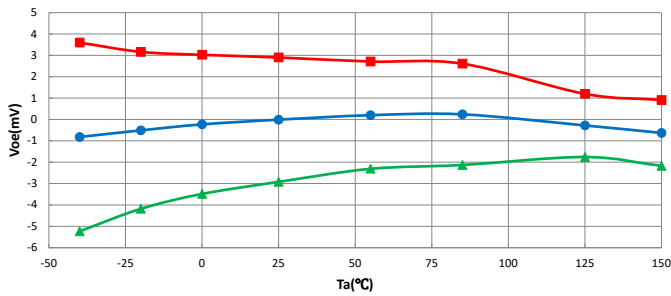

Sensitivity versus Ambient Temperature

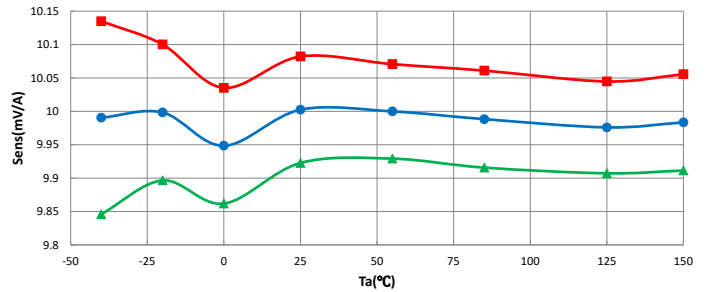

Nonlinearity versus Ambient Temperature

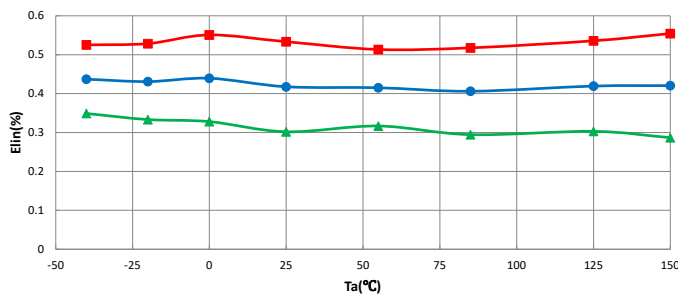

Total Output Error versus Ambient Temperature

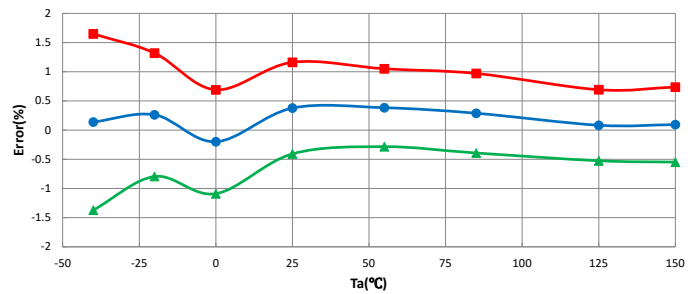

Magnetic Offset Error versus Ambient Temperature

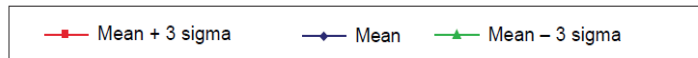
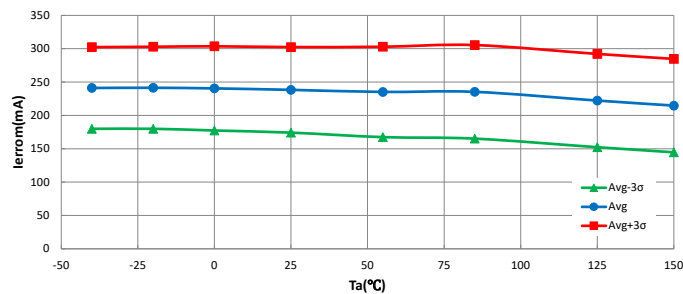

CHARACTERISTIC PERFORMANCE DATA

ACS772ECB-250U-PFF-T

Electrical Offset Voltage versus Ambient Temperature

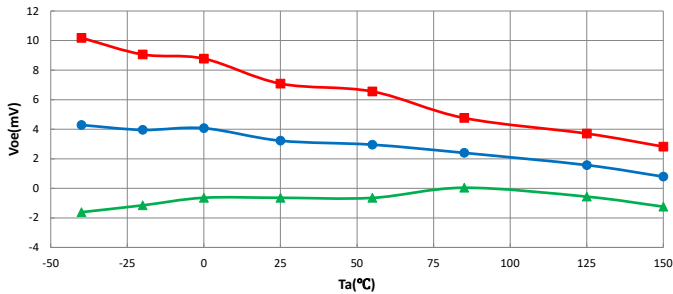

Sensitivity versus Ambient Temperature

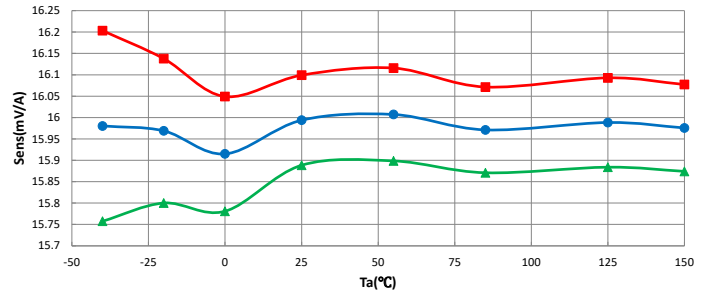

Nonlinearity versus Ambient Temperature

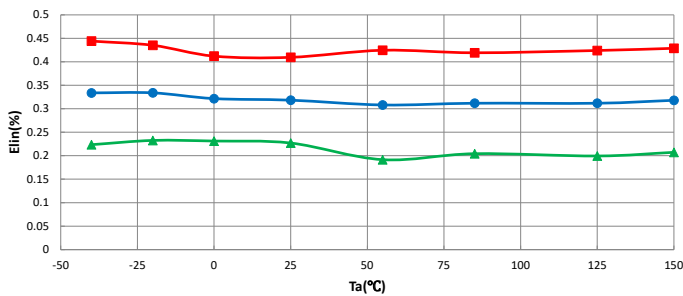

Total Output Error versus Ambient Temperature

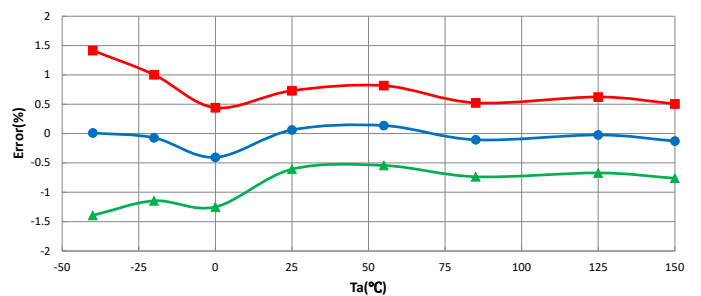

Magnetic Offset Error versus Ambient Temperature

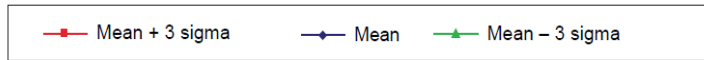
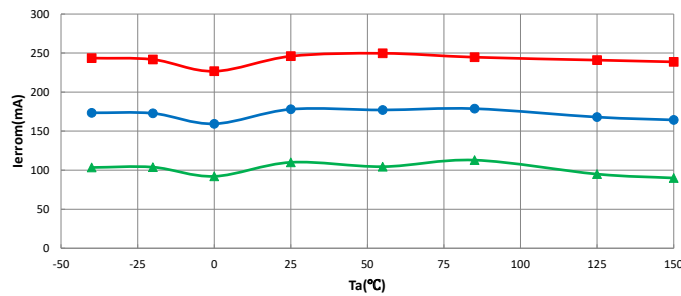

CHARACTERISTIC PERFORMANCE DATA

ACS772ECB-250B-PFF-T

Electrical Offset Voltage versus Ambient Temperature

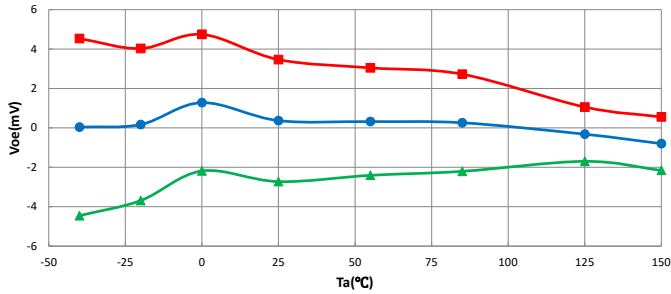

Sensitivity versus Ambient Temperature

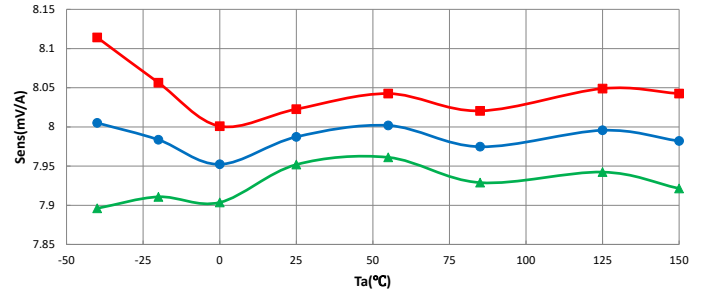

Nonlinearity versus Ambient Temperature

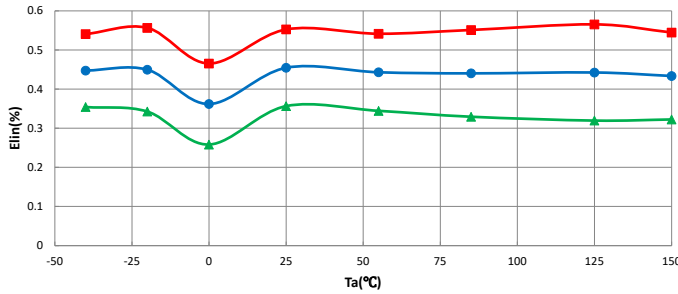

Total Output Error versus Ambient Temperature

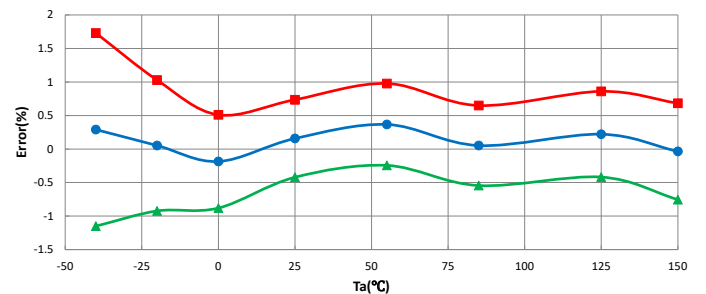

Magnetic Offset Error versus Ambient Temperature

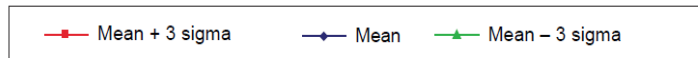
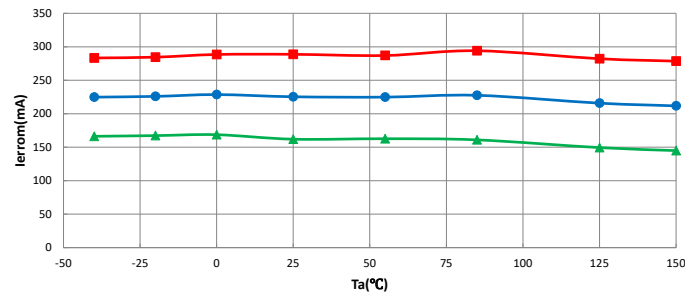

CHARACTERISTIC PERFORMANCE DATA

Response Time ($t_{RESPONSE}$)

70 A excitation signal with 10%-90% rise time = 1 μs

Sensitivity = 13.33 mV/A, $T_A = 25^\circ\text{C}$, $C_{BYPASS} = 0.1 \mu\text{F}$, $C_{LOAD} = 1 \text{ nF}$

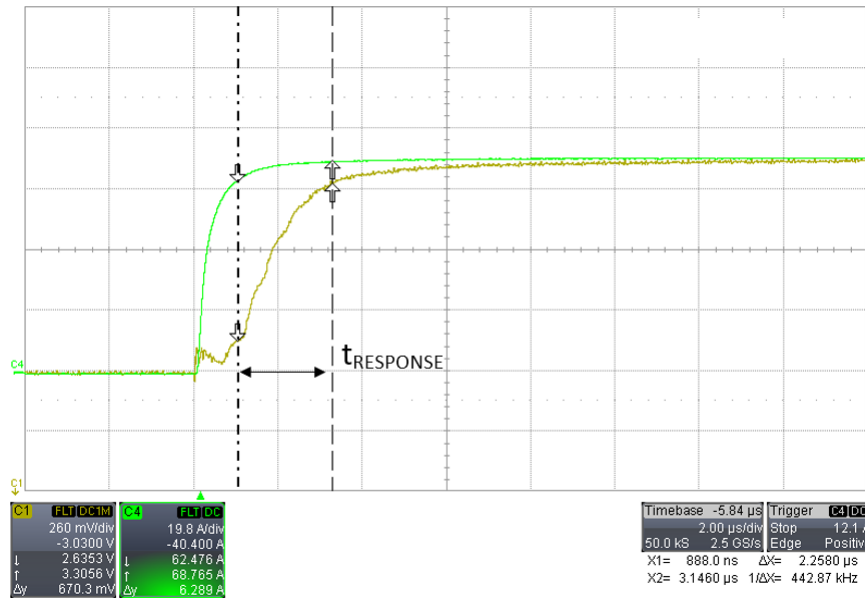

Propagation Delay (t_{PROP})

70 A excitation signal with 10%-90% rise time = 1 μs

Sensitivity = 13.33 mV/A, $T_A = 25^\circ\text{C}$, $C_{BYPASS} = 0.1 \mu\text{F}$, $C_{LOAD} = 1 \text{ nF}$

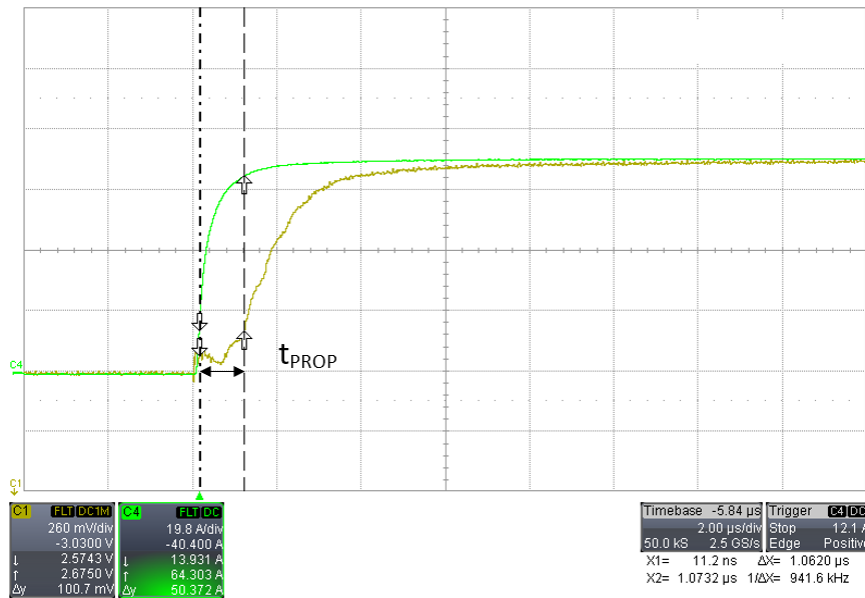

Rise Time (t_R)

70 A excitation signal with 10%-90% rise time = 1 μs

Sensitivity = 13.33 mV/A, $T_A = 25^\circ\text{C}$, $C_{\text{BYPASS}} = 0.1 \mu\text{F}$, $C_{\text{LOAD}} = 1 \text{ nF}$

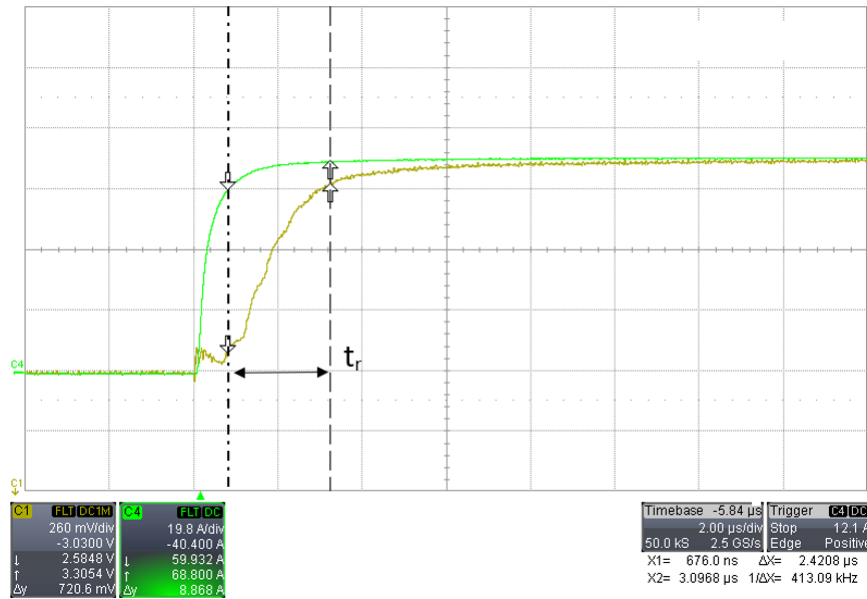

UVLO Enable Time (t_{UVLOE})

V_{CC} 5 V to 3 V fall time = 1.5 μs , C_L = 1 nF

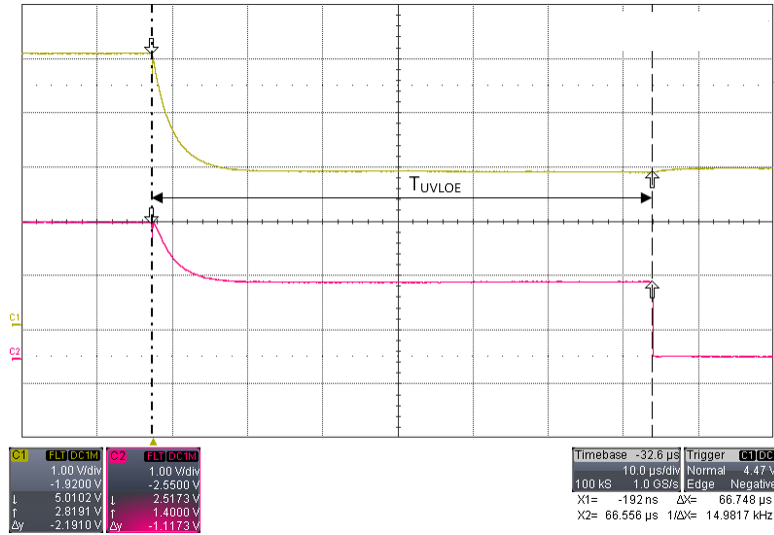

UVLO Disble Time (t_{UVLOD})

V_{CC} 3 V to 5 V recovery time = 1.5 μs , C_L = 1 nF

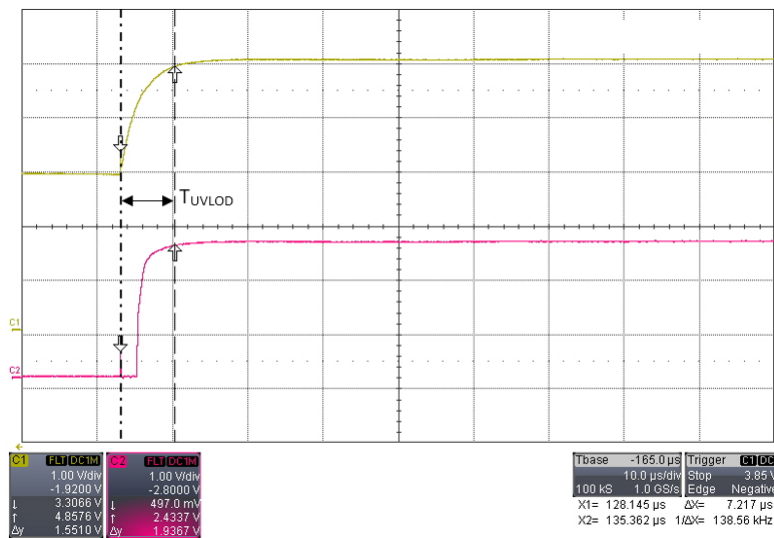

CHARACTERISTIC DEFINITIONS

Definitions of Accuracy Characteristics

SENSITIVITY (Sens)

The change in sensor IC output in response to a 1 A change through the primary conductor. The sensitivity is the product of the magnetic circuit sensitivity (G/A; 1 G = 0.1 mT) and the linear IC amplifier gain (mV/G). The linear IC amplifier gain is programmed at the factory to optimize the sensitivity (mV/A) for the full-scale current of the device.

SENSITIVITY ERROR (E_{Sens})

The sensitivity error is the percent difference between the measured sensitivity and the ideal sensitivity. For example, in the case of V_{CC} = 5 V:

$$E_{Sens} = \frac{Sens_{Meas(5V)} - Sens_{Ideal(5V)}}{Sens_{IDEAL(5V)}} \times 100 (\%)$$

NOISE (V_N)

The noise floor is derived from the thermal and shot noise observed in Hall elements. Dividing the noise (mV) by the sensitivity (mV/A) provides the smallest current that the device is able to resolve.

NONLINEARITY (E_{LIN})

The ACS772 is designed to provide a linear output in response to a ramping current. Consider two current levels: I₁ and I₂. Ideally, the sensitivity of a device is the same for both currents, for a given supply voltage and temperature. Nonlinearity is present when there is a difference between the sensitivities measured at I₁ and I₂. Nonlinearity is calculated separately for the positive (E_{LINpos}) and negative (E_{LINneg}) applied currents as follows:

$$E_{LINpos} = 100 (\%) \times \{1 - (Sens_{IPOS2} / Sens_{IPOS1})\}$$

$$E_{LINneg} = 100 (\%) \times \{1 - (Sens_{INEG2} / Sens_{INEG1})\}$$

where:

$$Sens_{Ix} = (V_{IOUT(Ix)} - V_{IOUT(Q)}) / Ix$$

and I_{POSx} and I_{NEGx} are positive and negative currents and I_{POS2} = 2 × I_{POS1} and I_{NEG2} = 2 × I_{NEG1}.

Then:

$$E_{LIN} = \max(E_{LINpos}, E_{LINneg})$$

SYMMETRY (E_{SYM})

The degree to which the absolute voltage output from the IC var-

ies in proportion to either a positive or negative half-scale primary current. The following equation is used to derive symmetry:

$$100 \times \left(\frac{V_{IOUT_{+half-scale\ amperes}} - V_{IOUT(Q)}}{V_{IOUT(Q)} - V_{IOUT_{-half-scale\ amperes}}} \right)$$

RATIOMETRY ERROR

The device features a ratiometric output. This means that the quiescent voltage output, V_{IOUTQ}, and the magnetic sensitivity, Sens, are proportional to the supply voltage, V_{CC}. The ratiometric change (%) in the quiescent voltage output is defined as:

$$Rat_{ErrQVO} = \left[1 - \frac{(V_{IOUTQ(VCC)} / V_{IOUTQ(5V)})}{V_{CC} / 5 V} \right] \times 100\%$$

and the ratiometric change (%) in sensitivity is defined as:

$$Rat_{ErrSens} = \left[1 - \frac{(Sens_{(VCC)} / Sense_{(5V)})}{V_{CC} / 5 V} \right] \times 100\%$$

ZERO CURRENT OUTPUT VOLTAGE (V_{IOUT(Q)})

The output of the sensor when the primary current is zero. It nominally remains at 0.5 × V_{CC} for a bidirectional device and 0.1 × V_{CC} for a unidirectional device. For example, in the case of a bidirectional output device, V_{CC} = 5 V translates into V_{IOUT(Q)} = 2.5 V. Variation in V_{IOUT(Q)} can be attributed to the resolution of the Allegro linear IC quiescent voltage trim and thermal drift.

ELECTRICAL OFFSET VOLTAGE (V_{OE})

The deviation of the device output from its ideal quiescent value of 0.5 × V_{CC} (bidirectional) or 0.1 × V_{CC} (unidirectional) due to nonmagnetic causes. To convert this voltage to amperes, divide by the device sensitivity, Sens.

MAGNETIC OFFSET ERROR (I_{ERRM})

The magnetic offset is due to the residual magnetism (remnant field) of the core material. The magnetic offset error is highest when the magnetic circuit has been saturated, usually when the device has been subjected to a full-scale or high-current overload condition. The magnetic offset is largely dependent on the material used as a flux concentrator. The larger magnetic offsets are observed at the lower operating temperatures.

TOTAL OUTPUT ERROR (E_{TOT})

The difference between the current measurement from the sensor IC and the actual current (I_P), relative to the actual current. This is equivalent to the difference between the ideal output voltage and the actual output voltage, divided by the ideal sensitivity, relative to the current flowing through the primary conduction path:

$$E_{TOT}(I_P) = \frac{V_{IOUT}(I_P) - V_{IOUT}(ideal)(I_P)}{Sens_{ideal} \times I_P} \times 100(\%)$$

where

$$V_{IOUT}(ideal)(I_P) = V_{IOUT}(Q) + (Sens_{IDEAL} \times I_P)$$

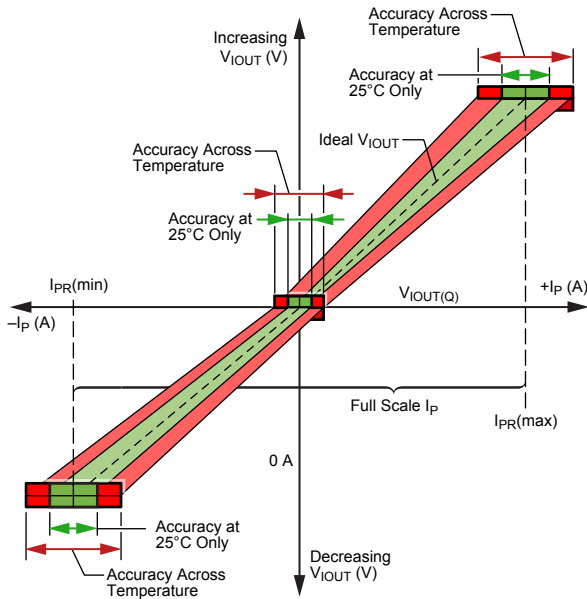

Figure 1: Output Voltage versus Sensed Current

The Total Output Error incorporates all sources of error and is a function of I_P .

At relatively high currents, E_{TOT} will be mostly due to sensitivity error, and at relatively low currents, E_{TOT} will be mostly due to Offset Voltage (V_{OE}). In fact, as I_P approaches zero, E_{TOT} approaches infinity due to the offset voltage. This is illustrated in Figure 1 and Figure 2. Figure 1 shows a distribution of output voltages versus I_P at 25°C and across temperature. Figure 2 shows the corresponding E_{TOT} versus I_P .

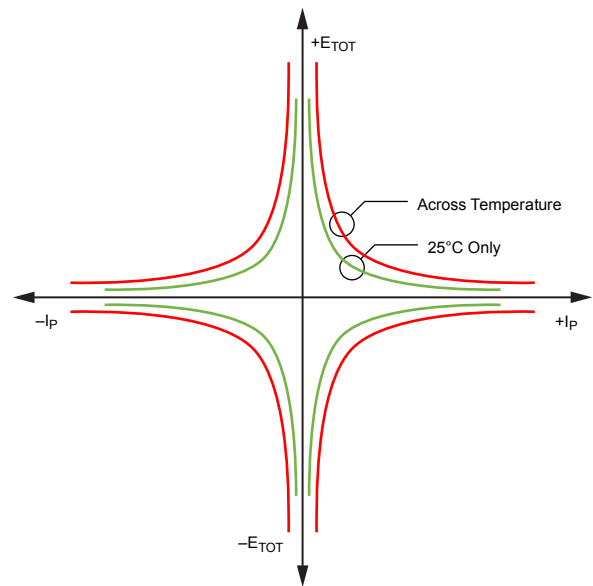

Figure 2: Total Output Error versus Sensed Current

Definitions of Dynamic Response Characteristics

POWER-ON DELAY (t_{POD})

When the supply is ramped to its operating voltage, the device requires a finite time to power its internal components before responding to an input magnetic field. Power-On Delay, t_{POD} , is defined as the time it takes for the output voltage to settle within $\pm 10\%$ of its steady-state value under an applied magnetic field, after the power supply has reached its minimum specified operating voltage, $V_{CC(min)}$, as shown in the chart at right.

RISE TIME (t_r)

The time interval between a) when the sensor reaches 10% of its full-scale value, and b) when it reaches 90% of its full-scale value.

PROPAGATION DELAY (t_{PROP})

The time interval between a) when the sensed current reaches 20% of its full-scale value, and b) when the sensor output reaches 20% of its full-scale value.

RESPONSE TIME ($t_{RESPONSE}$)

The time interval between a) when the applied current reaches 90% of its final value, and b) when the sensor reaches 90% of its output corresponding to the applied current.

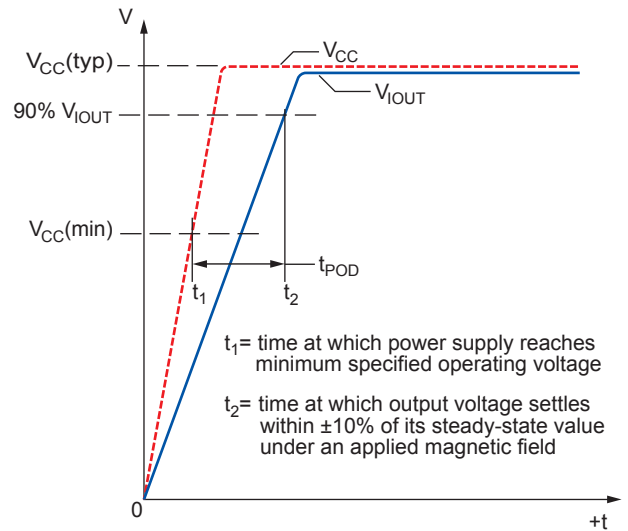

Figure 3: Power-On Delay (t_{POD})

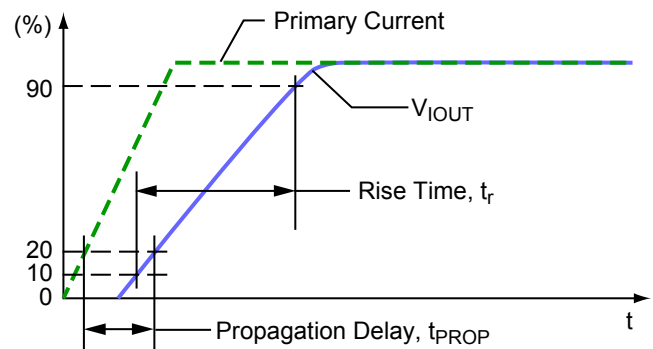

Figure 4: Rise Time (t_r) and Propagation Delay (t_{PROP})

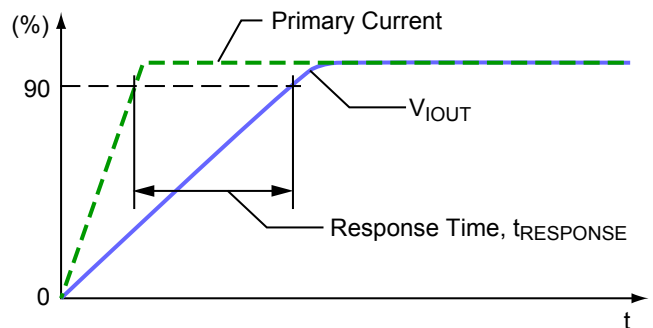

Figure 5: Response Time ($t_{RESPONSE}$)

FUNCTIONAL DESCRIPTION

Power-On Reset (POR) and Undervoltage Lockout (UVLO) Operation

The descriptions in this section assume: temperature = 25°C, no output load (RL, CL), and no significant magnetic field is present.

Power-Up

At power-up, as V_{CC} ramps up, the output is in a high-impedance state. When V_{CC} crosses V_{PORH} (location [1] in Figure 6 and [1'] in Figure 7), the POR Release counter starts counting for t_{PORR} . At this point, if V_{CC} exceeds V_{UVLOH} [2'], the output will go to $V_{CC}/2$ after t_{UVLOD} [3'].

If V_{CC} does not exceed V_{UVLOH} [2], the output will stay in the high-impedance state until V_{CC} reaches V_{UVLOH} [3] and then will go to $V_{CC}/2$ after t_{UVLOD} [4].

V_{CC} drops below $V_{CC}(\min) = 4.5\text{ V}$

If V_{CC} drops below V_{UVLOL} [4', 5], the UVLO Enable Counter starts counting. If V_{CC} is still below V_{UVLOL} when the counter reaches t_{UVLOE} , the UVLO function will be enabled and the

output will be pulled near GND [6]. If V_{CC} exceeds V_{UVLOL} before the UVLO Enable Counter reaches t_{UVLOE} [5'], the output will continue to be $V_{CC}/2$.

Coming Out of UVLO

While UVLO is enabled [6], if V_{CC} exceeds V_{UVLOH} [7], UVLO will be disabled after t_{UVLOD} , and the output will be $V_{CC}/2$ [8].

Power-Down

As V_{CC} ramps down below V_{UVLOL} [6', 9], the UVLO Enable Counter will start counting. If V_{CC} is higher than V_{PORL} when the counter reaches t_{UVLOE} , the UVLO function will be enabled and the output will be pulled near GND [10]. The output will enter a high-impedance state as V_{CC} goes below V_{PORL} [11]. If V_{CC} falls below V_{PORL} before the UVLO Enable Counter reaches t_{UVLOE} , the output will transition directly into a high-impedance state [7'].

EEPROM Error Checking And Correction

Hamming code methodology is implemented for EEPROM checking and correction. The device has ECC enabled after power-up. If an uncorrectable error has occurred, the VOUT pin will go to high impedance and the device will not respond to applied magnetic field.

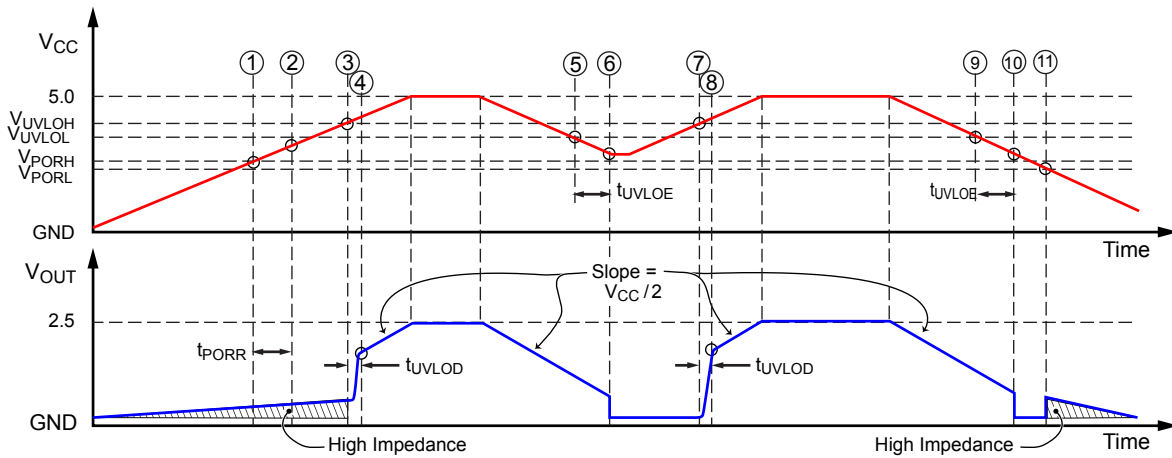

Figure 6: POR and UVLO Operation: Slow Rise Time Case

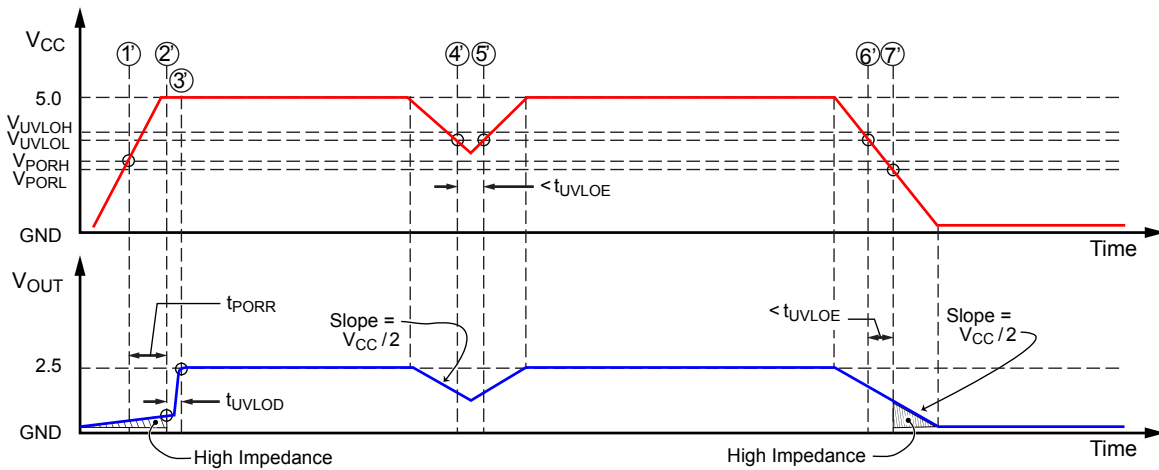

Figure 7: POR and UVLO Operation: Fast Rise Time Case

Chopper Stabilization Technique

When using Hall-effect technology, a limiting factor for switchpoint accuracy is the small signal voltage developed across the Hall element. This voltage is disproportionately small relative to the offset that can be produced at the output of the Hall sensor IC. This makes it difficult to process the signal while maintaining an accurate, reliable output over the specified operating temperature and voltage ranges.

Chopper stabilization is a unique approach used to minimize Hall offset on the chip. Allegro employs a technique to remove key sources of the output drift induced by thermal and mechanical stresses. This offset reduction technique is based on a signal modulation-demodulation process. The undesired offset signal is separated from the magnetic field-induced signal in the frequency domain, through modulation. The subsequent demodulation acts as a modulation process for the offset, causing the magnetic field-induced signal to recover its original spectrum at baseband, while the DC offset becomes a high-frequency signal. The magnetic-

sourced signal then can pass through a low-pass filter, while the modulated DC offset is suppressed.

In addition to the removal of the thermal and stress related offset, this novel technique also reduces the amount of thermal noise in the Hall sensor IC while completely removing the modulated residue resulting from the chopper operation. The chopper stabilization technique uses a high-frequency sampling clock. For demodulation process, a sample-and-hold technique is used. This high-frequency operation allows a greater sampling rate, which results in higher accuracy and faster signal-processing capability. This approach desensitizes the chip to the effects of thermal and mechanical stresses, and produces devices that have extremely stable quiescent Hall output voltages and precise recoverability after temperature cycling. This technique is made possible through the use of a BiCMOS process, which allows the use of low-offset, low-noise amplifiers in combination with high-density logic integration and sample-and-hold circuits.

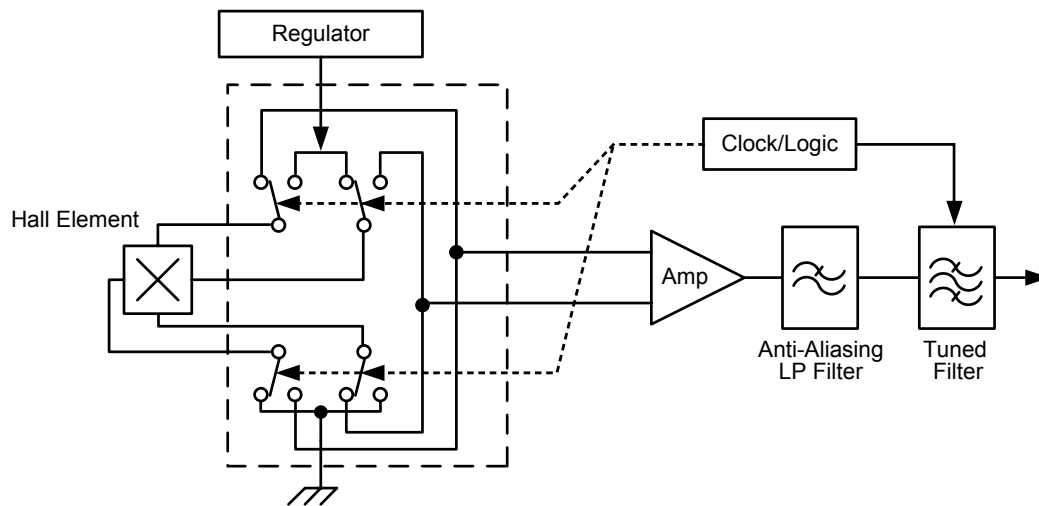

Figure 8: Concept of Chopper Stabilization Technique

APPLICATION INFORMATION

Thermal Rise vs. Primary Current

Self-heating due to the flow of current should be considered during the design of any current sensing system. The sensor, printed circuit board (PCB), and contacts to the PCB will generate heat as current moves through the system.

The thermal response is highly dependent on PCB layout, copper thickness, cooling techniques, and the profile of the injected current. The current profile includes peak current, current “on-time”, and duty cycle. While the data presented in this section was collected with direct current (DC), these numbers may be used to approximate thermal response for both AC signals and current pulses.

The plot in Figure 9 shows the measured rise in steady-state die temperature of the ACS772 versus DC input current at an ambient temperature, T_A , of 25°C. The thermal offset curves may be directly applied to other values of T_A .

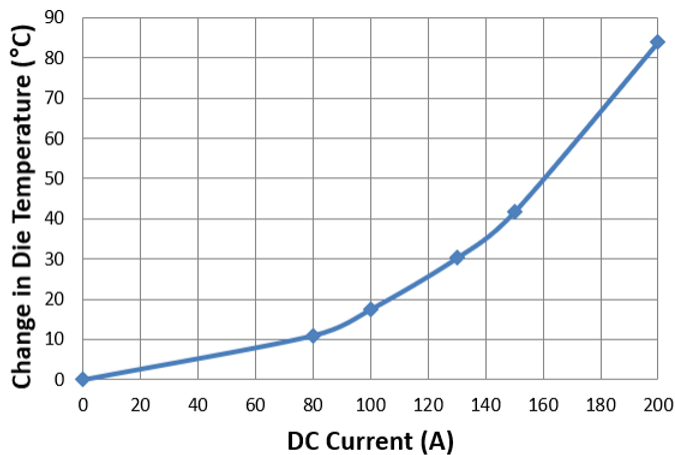

Figure 9: Self-Heating in the CB Package Due to Current Flow

The thermal capacity of the ACS772 should be verified by the end user in the application’s specific conditions. The maximum junction temperature, $T_{J(max)}$, should not be exceeded. Further information on this application testing is available in the DC Current Capability and Fuse Characteristics of Current Sensor ICs with 50 to 200 A Measurement Capability application note on the Allegro website (<https://www.allegromicro.com/en/Design-Center/Technical-Documents/Hall-Effect-Sensor-IC-Publications/DC-Current-Capability-Fuse-Characteristics-Current-Sensor-ICs-50-200-A.aspx>).

ASEK772 Evaluation Board Layout

Thermal data shown in Figure 9 was collected using the ASEK772 Evaluation Board (TED-85-0385-001). This board includes 1500 mm² of 2 oz. (0.0694 mm) copper connected to pins 4 and 5, with thermal vias connecting the layers. Top and bottom layers of the PCB are shown below in Figure 10.

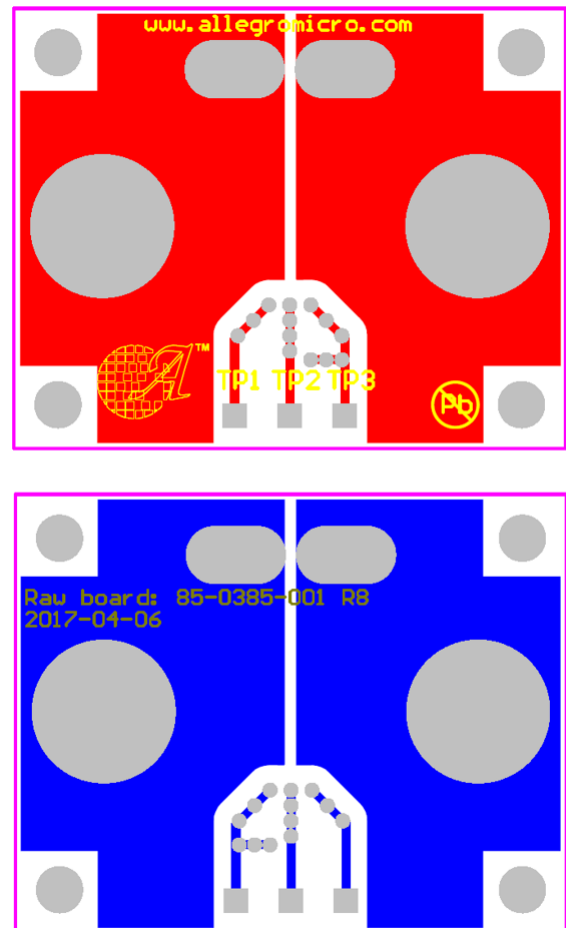

Figure 10: Top and Bottom Layers for ASEK772 Evaluation Board

Gerber files for the ASEK772 evaluation board are available for download from the Allegro website; see the technical documents section of the ACS772 webpage (<https://www.allegromicro.com/en/Products/Current-Sensor-ICs/Fifty-To-Two-Hundred-Amp-Integrated-Conductor-Sensor-ICs/ACS772.aspx>).

PACKAGE OUTLINE DRAWING

For Reference Only – Not for Tooling Use

(Reference DWG-9111 & DWG-9110)
Dimensions in millimeters – NOT TO SCALE
Dimensions exclusive of mold flash, gate burs, and dambar protrusions
Exact case and lead configuration at supplier discretion within limits shown

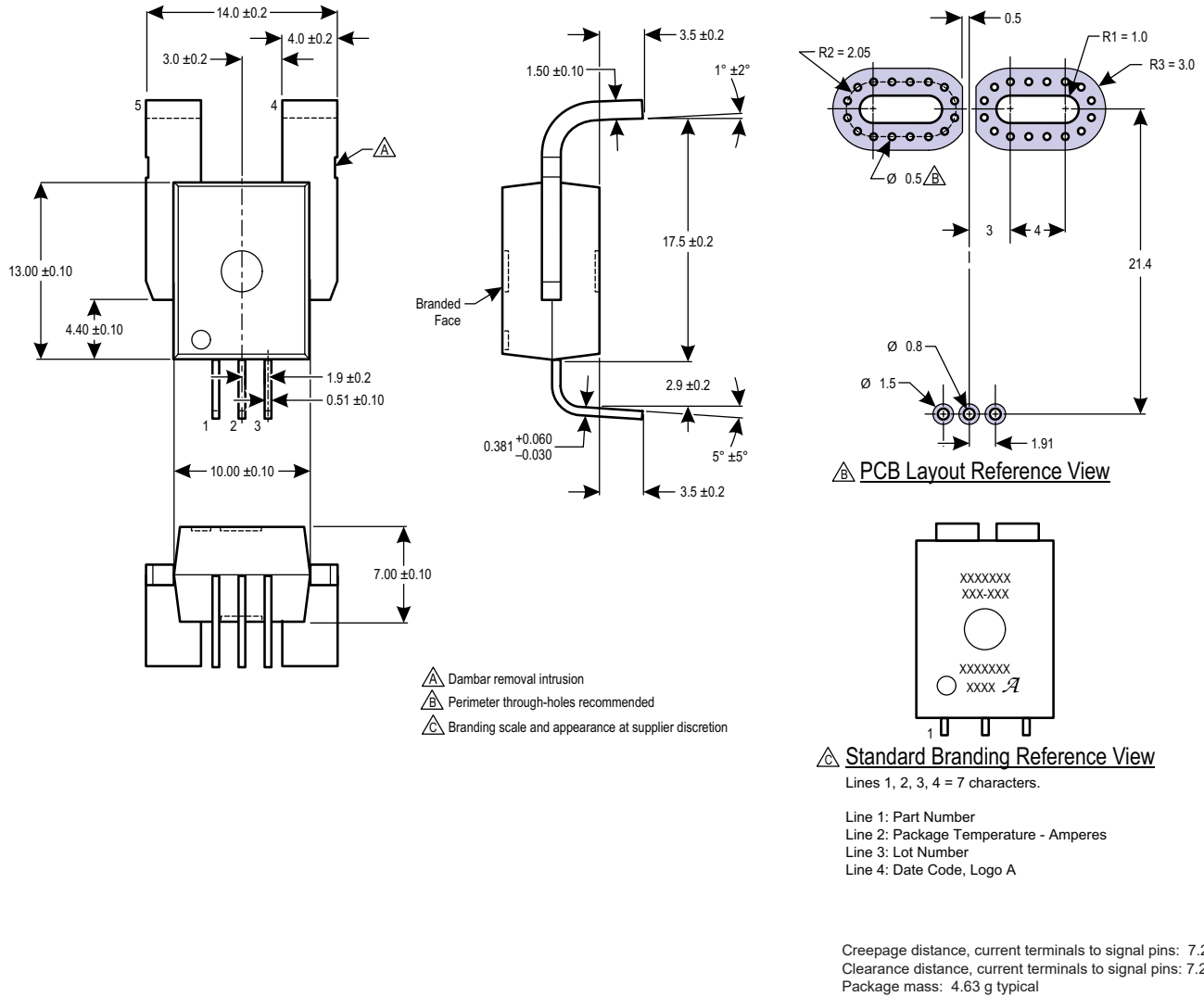

Figure 11: Package CB, 5-Pin, Leadform PFF

For Reference Only – Not for Tooling Use

(Reference DWG-9111, DWG-9110)
Dimensions in millimeters – NOT TO SCALE
Dimensions exclusive of mold flash, gate burs, and dambar protrusions
Exact case and lead configuration at supplier discretion within limits shown

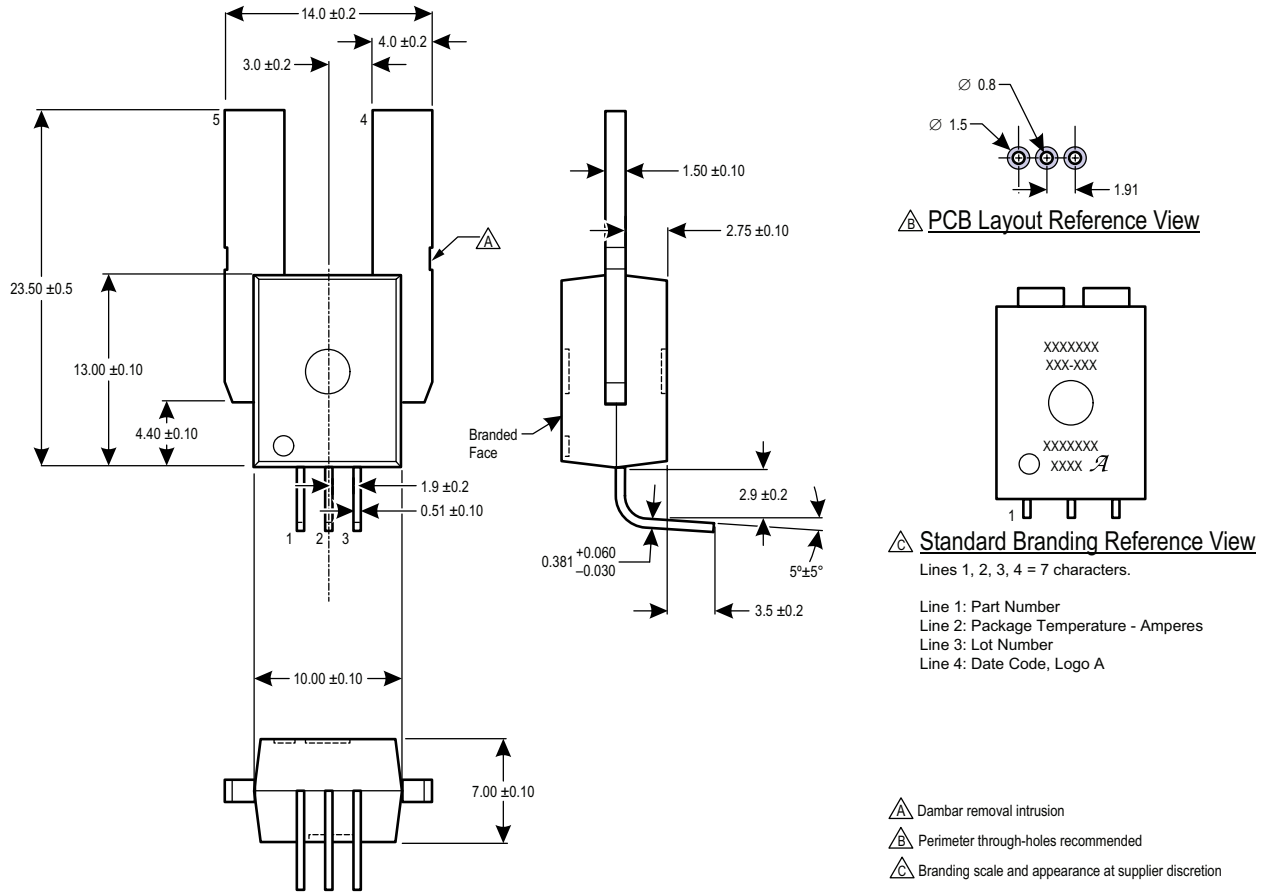

Figure 12: Package CB, 5-Pin, Leadform PSF

For Reference Only – Not for Tooling Use

(Reference DWG-9111, DWG-9110)
Dimensions in millimeters – NOT TO SCALE
Dimensions exclusive of mold flash, gate burs, and dambar protrusions
Exact case and lead configuration at supplier discretion within limits shown

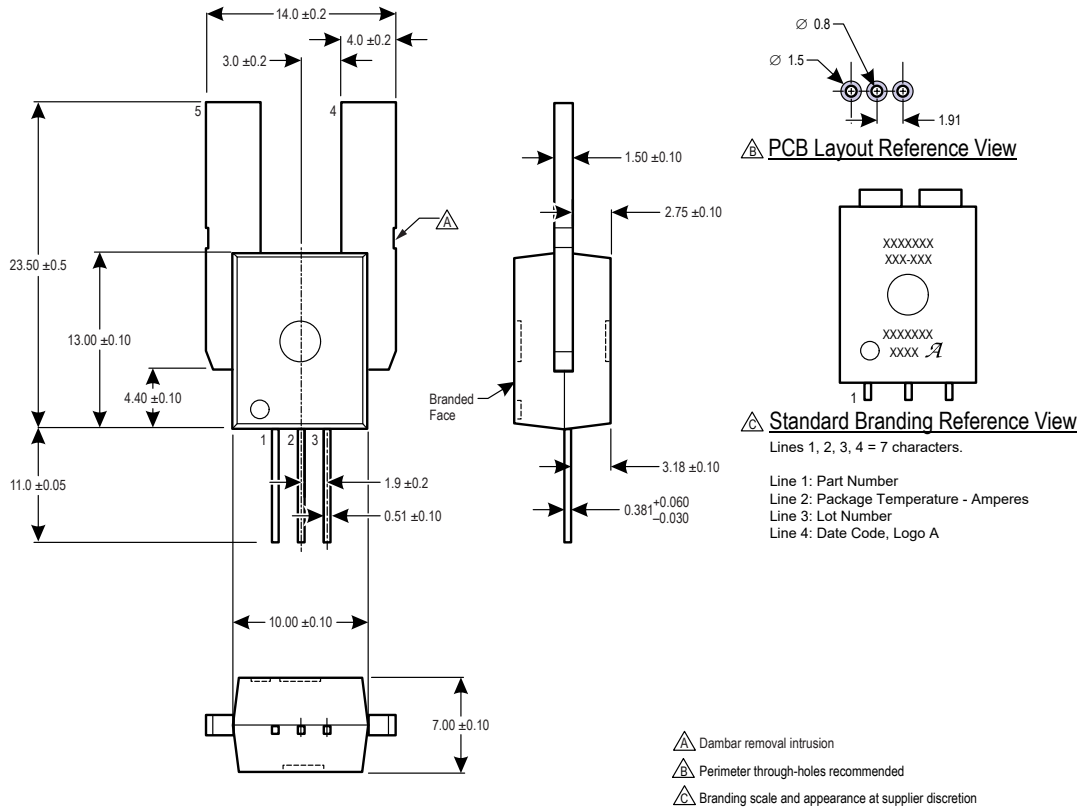

Figure 13: Package CB, 5-Pin, Leadform PSS

Revision History

| Number | Date | Description |
|--------|--------------------|---|
| – | December 12, 2017 | Initial release |
| 1 | January 30, 2018 | Added Dielectric Surge Strength Test Voltage characteristic (page 3) and EEPROM Error Checking and Correction section (page 16) |
| 2 | May 14, 2018 | Added -050U, -100B, -150U, -200U, -250U, and -250B part options |
| 3 | September 24, 2018 | Added -PSF leadform option; updated Magnetic Offset Error value (page 13) and Characteristic Performance Data charts (pages 26 to 28) |
| 4 | November 12, 2018 | Added -300B part option (page 2 and 16); added -PSS leadform option (pages 1, 2, and 39) and Applications Information section (page 36); updated Typical Application (page 1), pinout diagram (page 4), and T_{OP} to T_A (pages 2 and 5-15). |
| 5 | December 13, 2018 | Added UL certificate; updated package outline drawing PCB layouts and branding (pages 37-39) |
| 6 | January 7, 2019 | Corrected Sensitivity Error values for -200U part option (page 12) |
| 7 | January 24, 2019 | Added -400B part option (page 2 and 17) |
| 8 | March 14, 2019 | Updated package branding (pages 38-40) and Temperature ratings (pages 2-3, 6-17) |

Copyright 2019, Allegro MicroSystems, LLC

Allegro MicroSystems, LLC reserves the right to make, from time to time, such departures from the detail specifications as may be required to permit improvements in the performance, reliability, or manufacturability of its products. Before placing an order, the user is cautioned to verify that the information being relied upon is current.

Allegro's products are not to be used in any devices or systems, including but not limited to life support devices or systems, in which a failure of Allegro's product can reasonably be expected to cause bodily harm.

The information included herein is believed to be accurate and reliable. However, Allegro MicroSystems, LLC assumes no responsibility for its use; nor for any infringement of patents or other rights of third parties which may result from its use.

Copies of this document are considered uncontrolled documents.

For the latest version of this document, visit our website:

www.allegromicro.com