

SMD LED LAMP
BL-LS3216C0E1
Features:

- 3.2mmx1.6mm SMD, 1.1mm THICKNESS
- Mono-color type
- Compatible with automatic placement equipment
- WIDE VIEWING ANGLE.
- IDEAL FOR BACKLIGHT AND INDICATOR.
- PACKAGE: 3KPCS/REEL
- RoHs Compliance

■ Electrical-optical characteristics: (Ta=25°C) (Test Condition: IF=20mA)

Part Number	Chip			Lens Type	Forward Voltage(VF) Unit:V		Luminous Intensity (Iv) Unit:mcd		Viewing Angle 2θ1/2 (deg)
	Emitted Color	Material	λ _P (nm)		Typ	Max	Min.	Typ.	
BL-LS3216C0E1HC	Red	GaP	700	Water Clear	2.2	2.7	0.3	0.9	140
BL-LS3216C0E1SRC	Super Red	AlGaAs	660		1.85	2.30	5	13	
BL-LS3216C0E1LRC	Super Red	AlGaAs	660		1.85	2.30	10	28	
BL-LS3216C0E1EC	Red	GaAsP	640		2.10	2.70	1	6	
BL-LS3216C0E1YC	Yellow	GaAsP	583		2.15	2.70	1	6	
BL-LS3216C0E1GC	Green	GaP	568		2.30	2.70	6	15	

■ Absolute maximum ratings (Ta=25°C)

Parameter	H	SR	LR	UR	E	Y	G	Unit
Forward Current I _F	30	30	30	30	30	30	30	mA
Power Dissipation P _d	65	78	78	78	65	65	65	mW
Reverse Voltage V _R	5	5	5	5	5	5	5	V
Peak Forward Current I _{PF} (Duty 1/10 @1KHZ)	100	100	100	100	100	100	100	mA
Operation Temperature T _{OPR}	-30 to +80							°C
Storage Temperature T _{STG}	-40 to +85							°C
Lead Soldering Temperature T _{SOL}	Max.260±5°C for 3 sec Max. (1.6mm from the base of the epoxy bulb)							°C

SMD LED LAMP
BL-LS3216C0E1
Electrical-optical characteristics: (Ta=25°C) (Test Condition: IF=20mA)

Part Number	Chip			Lens Type	Forward Voltage(VF) Unit:V		Luminous Intensity (Iv) Unit:mcd		Viewing Angle 2θ1/2 (deg)
	Emitted Color	Material	λ _P (nm)		Typ	Max	Min.	Typ.	
BL-LS3216C0E1UDR	Ultra Red	AlGaAs	655	Water Clear	2.10	2.50	22	55	140
BL-LS3216C0E1UHR	Ultra Red	AlGaAs	645		2.10	2.60	30	80	
BL-LS3216C0E1UEC	Ultra Red	AlGaAs	630		2.10	2.50	30	80	
BL-LS3216C0E1UHD	Ultra Red	AlGaAs	618		2.10	2.60	50	110	
BL-LS3216C0E1UYO	Ultra Amber	AlGaInP	610		2.10	2.60	25	65	
BL-LS3216C0E1UYC	Ultra Yellow	AlGaInP	593		2.10	2.60	25	70	
BL-LS3216C0E1UGC	Ultra Green	AlGaInP	575		2.20	2.70	15	45	
BL-LS3216C0E1PGC	Ultra Pure Green	InGaN	525		3.50	4.20	15	100	
BL-LS3216C0E1BGC	Ultra Bluish Green	InGaN	505		3.50	4.20	30	110	
BL-LS3216C0E1DNB	Blue	InGaN	470		3.50	4.20	15	40	
BL-LS3216C0E1UBC	Ultra Blue	InGaN	470		3.50	4.20	10	30	
BL-LS3216C0E1UWC	Ultra White	InGaN	/		3.50	4.20	100	270	

Absolute maximum ratings (Ta=25°C)

Parameter	UDR	UHR	UE	UHD	UYO	UY	UG	PG	BG	DNB	UB	UW	Unit
Forward Current I _F	30	30	30	30	30	30	30	30	30	30	30	30	mA
Power Dissipation P _d	78	78	78	78	78	78	78	78	78	78	78	78	mW
Reverse Voltage V _R	5	5	5	5	5	5	5	5	5	5	5	5	V
Peak Forward Current I _{PF} (Duty 1/10 @1KHZ)	100	100	100	100	100	100	100	100	100	100	100	100	mA
Operation Temperature T _{OPR}	-30 to +80												°C
Storage Temperature T _{STG}	-40 to +85												°C
Lead Soldering Temperature T _{SOL}	Max.260±5 °C for 3 sec Max. (1.6mm from the base of the epoxy bulb)												°C

SMD LED LAMP

BL-LS3216C0E1

■ **Package configuration & Internal circuit diagram**

**BL-LS3216C0E1 Series
Package Outline Drawing**

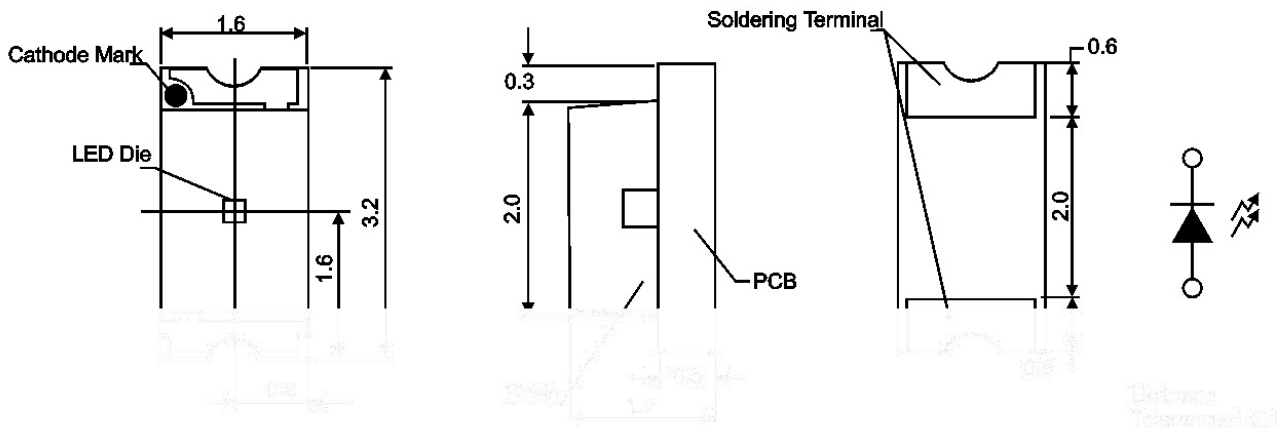

Recommended Soldering Pad Dimensions:

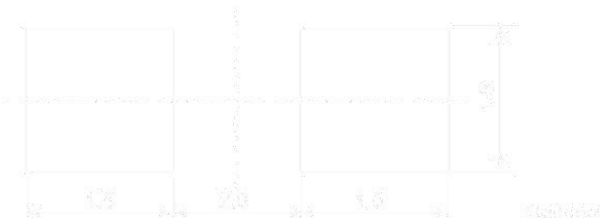

Notes:

1. All dimensions are in millimeters (inches)
2. Tolerance is $\pm 0.25(0.01)$ unless otherwise noted.
3. Specifications are subject to change without notice.

SMD LED LAMP

BL-LS3216C0E1

■ **Tape Specifications**

Unit : mm

Tolerance : ± 0.1

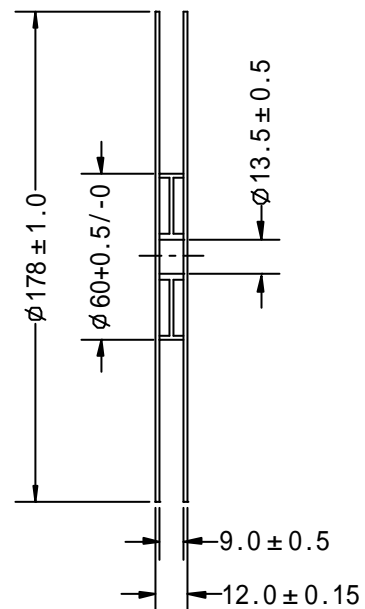
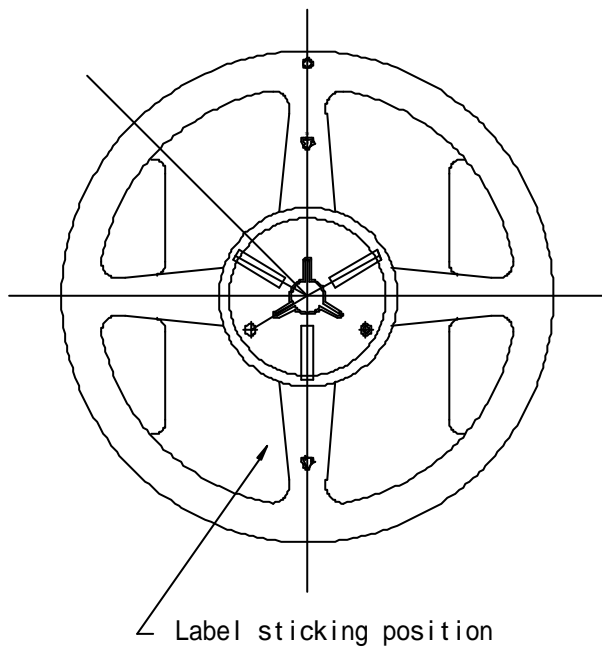
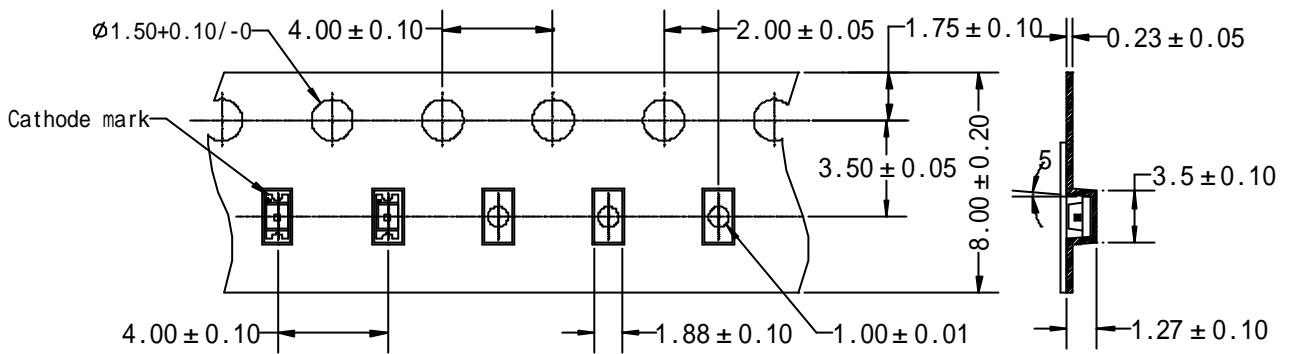

SMD LED LAMP

BL-LS3216C0E1

Typical electrical-optical characteristics curves:

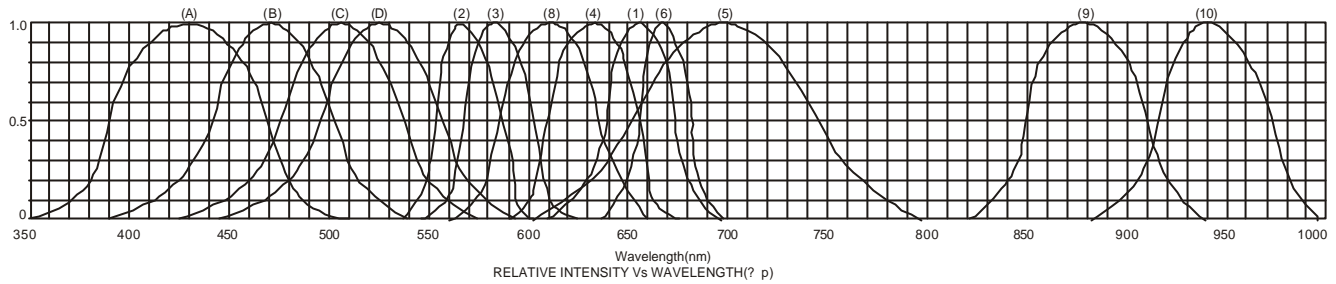

- (1) - GaAsP/GaAs 655nm/Red
- (2) - GaP 570nm/Yellow Green
- (3) - GaAsP/GaP 585nm/Yellow
- (4) - GaAsP/GaP 635nm/Orange & Hi-Eff Red
- (5) - GaP 700nm/Bright Red
- (6) - GaAlAs/GaAs 660nm/Super Red
- (8) - GaAsP/GaP 610nm/Super Red
- (9) - GaAlAs 880nm
- (10) - GaAs/GaAs & GaAlAs/GaAs 940nm
- (A) - GaN/SiC 430nm/Blue
- (B) - InGaN/SiC 470nm/Blue
- (C) - InGaN/SiC 505nm/Ultra Green
- (D) - InGaAl/SiC 525nm/Ultra Green

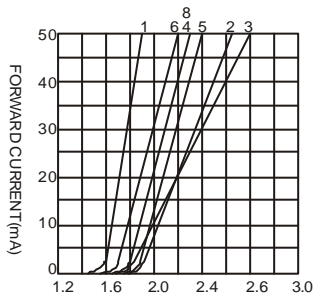

FORWARD VOLTAGE (Vf)
FORWARD CURRENT VS.
FORWARD VOLTAGE

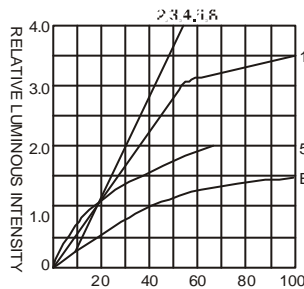

FORWARD CURRENT (mA)
RELATIVE LUMINOUS
INTENSITY VS. FORWARD
CURRENT

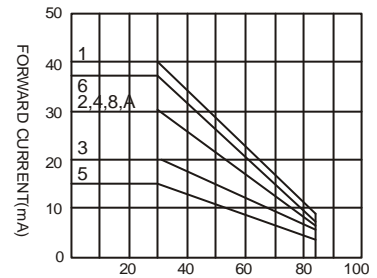

AMBIENT TEMPERATURE Ta ()
FORWARD CURRENT VS. AMBIENT
TEMPERATURE

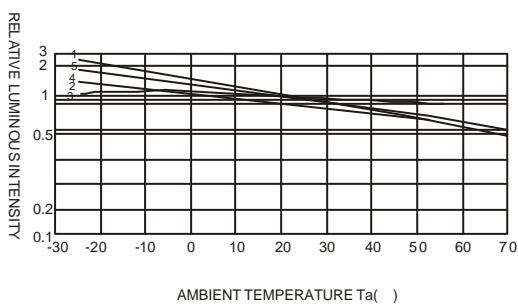

AMBIENT TEMPERATURE Ta ()

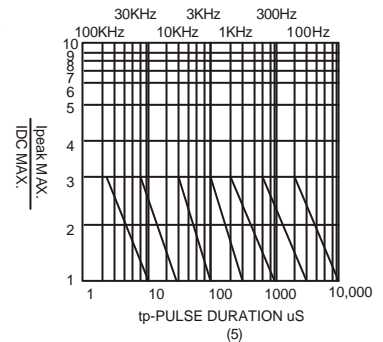
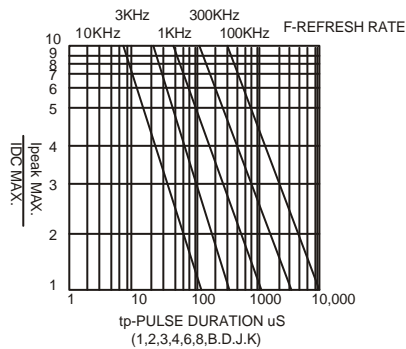

NOTE:25 free air temperature unless otherwise specified

SMD LED LAMP

BL-LS3216C0E1

■ **Packing and weighting**

