

4 TERMINAL 3A OUTPUT LOW DROP VOLTAGE REGULATOR

The KIA378R × × Series are Low Drop Voltage Regulator suitable for various electronic equipments. It provides constant voltage power source with TO-220IS-4 terminal lead full molded PKG.

The Regulator has multi-function such as over current protection, overheat protection and ON/OFF control.

FEATURES

- 3.0A Output Low Drop Voltage Regulator.
- Built in ON/OFF Control Terminal.
- Built in Over Current Protection, Over Heat Protection Function.

LINE UP

ITEM	OUTPUT VOLTAGE (Typ.)	UNIT
KIA378R05PI	5	V
KIA378R06PI	6	
KIA378R08PI	8	
KIA378R09PI	9	
KIA378R10PI	10	
KIA378R12PI	12	
KIA378R15PI	15	

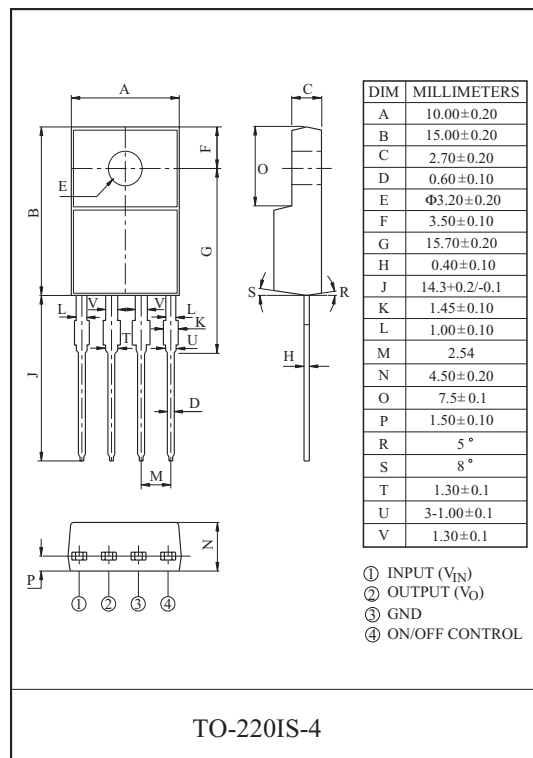

MAXIMUM RATINGS (Ta=25 °C)

CHARACTERISTIC	SYMBOL	RATING	UNIT	Remark
Input Voltage	V _{IN}	35	V	-
ON/OFF Control Voltage	V _C	35	V	-
Output Current	I _O	3	A	-
Power Dissipation 1	P _{d1}	1.5	W	No heatsink
Power Dissipation 2	P _{d2}	15	W	with heatsink
Operating Junction Temperature	T _{J(opr)}	-40 ~ 150	°C	-
Storage Temperature	T _{stg}	-45 ~ 150	°C	-
Soldering Temperature (10sec)	T _{sol}	260	°C	-

KIA378R05PI~KIA378R15PI

ELECTRICAL CHARACTERISTICS (Unless otherwise specified, $I_O=1.0A$, $T_a=25\text{ }^\circ\text{C}$, Note1.)

CHARACTERISTIC	SYMBOL	CONDITIONS	MIN.	TYP.	MAX.	UNIT
Output Voltage	KIA378R05	-	4.88	5.0	5.12	V
	KIA378R06	-	5.85	6.0	6.15	
	KIA378R08	-	7.80	8.0	8.2	
	KIA378R09	-	8.78	9.0	9.22	
	KIA378R10	-	9.75	10.0	10.25	
	KIA378R12	-	11.70	12.0	12.30	
	KIA378R15	-	14.70	15.0	15.30	
Load Regulation	Reg Load	$I_O=5\text{mA} \sim 3A$	-	0.1	2.0	%
Line Regulation	Reg Line	(Note 2)	-	0.5	2.5	%
Temperature Coefficient of Output Voltage	$T_C V_O$	$T_j=0 \sim 125\text{ }^\circ\text{C}$	-	± 0.02	± 0.05	%/ $^\circ\text{C}$
Ripple Rejection	$R \cdot R$	-	45	55	-	dB
Drop Out Voltage	V_D	$I_O=3A$	-	-	0.5	V
Output ON state for control Voltage	$V_{C(ON)}$	-	2.0	-	-	V
Output ON state for control Current	$I_{C(ON)}$	$V_C=2.7V$	-	-	20	μA
Output OFF state for control Voltage	$V_{C(OFF)}$	-	-	-	0.8	V
Output OFF state for control Current	$I_{C(OFF)}$	$V_C=0.4V$	-	-	-0.4	mA
Quiescent Current	I_Q	$I_O=0$	-	-	10	mA

Note1) V_{IN} of KIA378R05=7V

Note2) V_{IN} of KIA378R05=6~12V

Note3) At $V_{IN}=0.95V_O$

" KIA378R06=8V

" KIA378R06=7~15V

" KIA378R08=10V

" KIA378R08=9~25V

" KIA378R09=15V

" KIA378R09=10~25V

" KIA378R10=16V

" KIA378R10=11~26V

" KIA378R12=18V

" KIA378R12=13~29V

" KIA378R15=21V

" KIA378R15=16~32V

BLOCK DIAGRAM

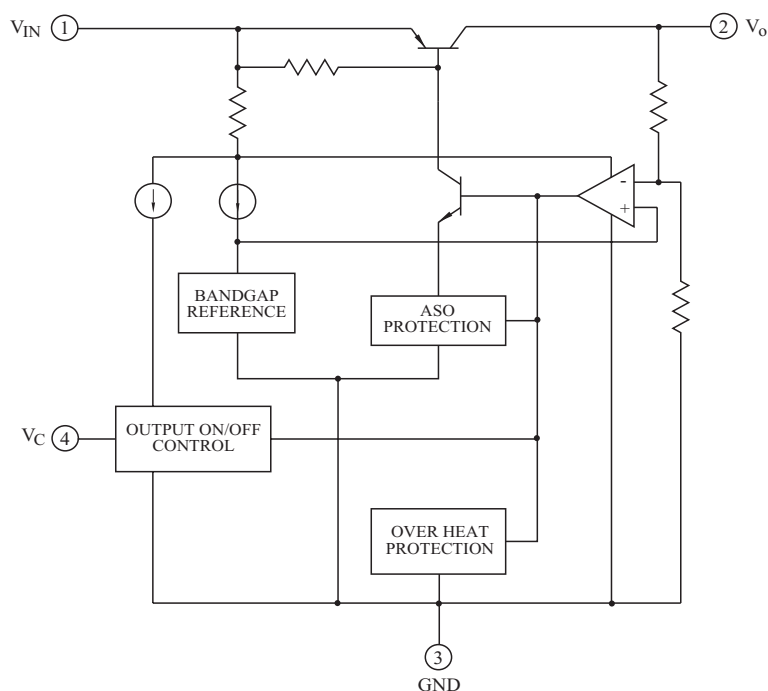

KIA378R05PI~KIA378R15PI

Fig. 1 Standard Test Circuit

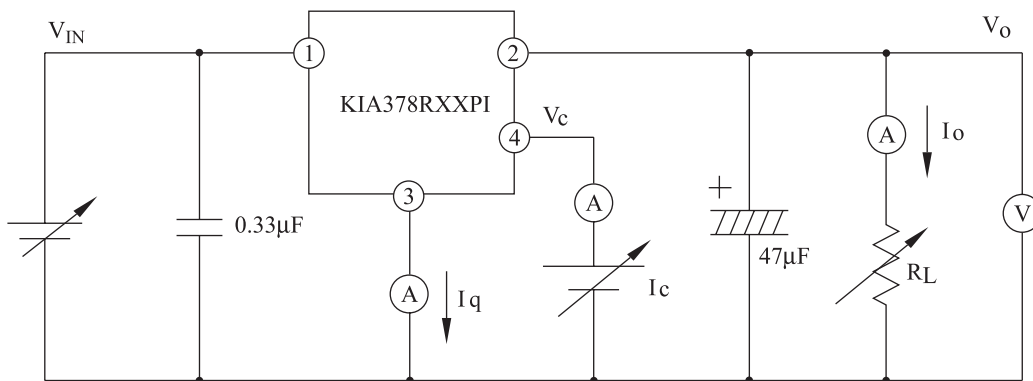

Fig. 1-2 Ripple Rejection Test Circuit

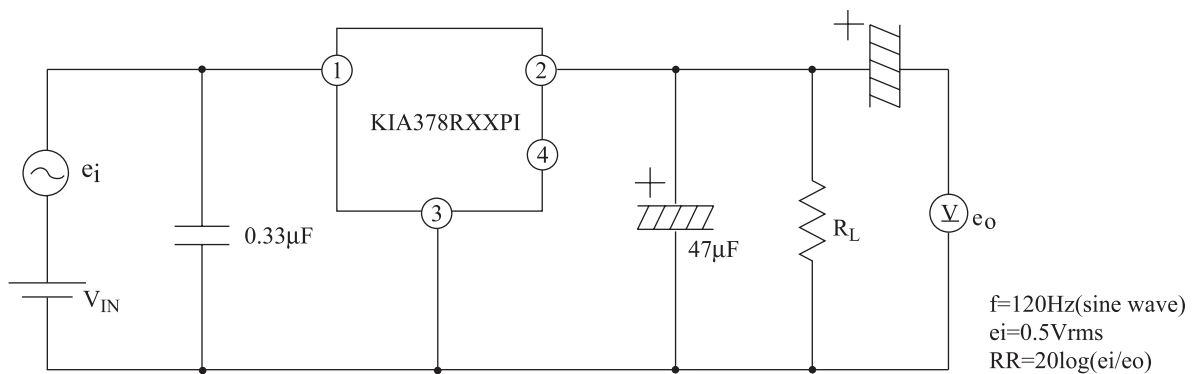
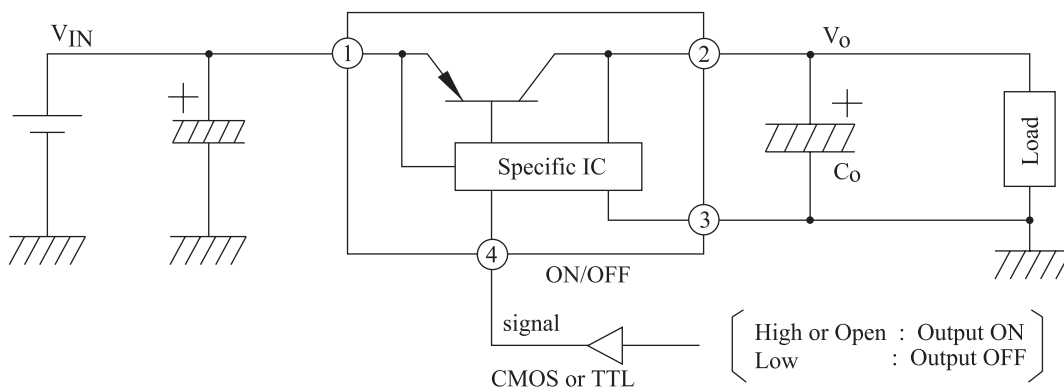
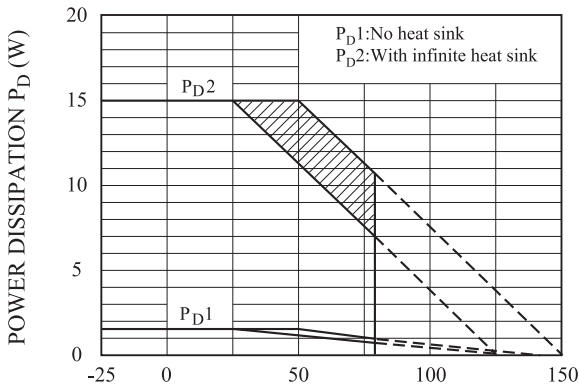

Fig. 2 Application Circuit for Standard



KIA378R05PI~KIA378R15PI

Fig.3 T_a - P_D



AMBIENT TEMPERATURE T_a (°C)

Note) Oblique line portion : Overheat protection may operate in this area.

Fig.4 I_O - V_O

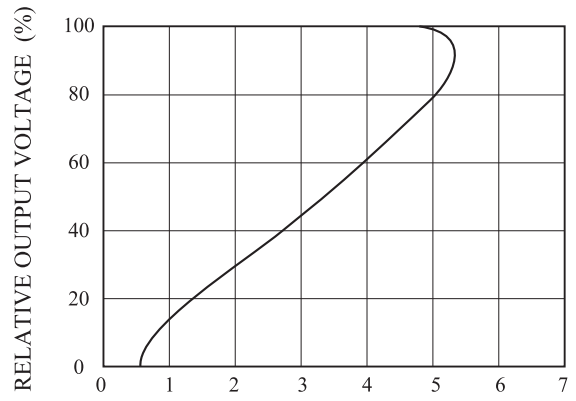

OUTPUT CURRENT I_O (A)

Fig.5-1 T_j - ΔV_O (KIA378R05)

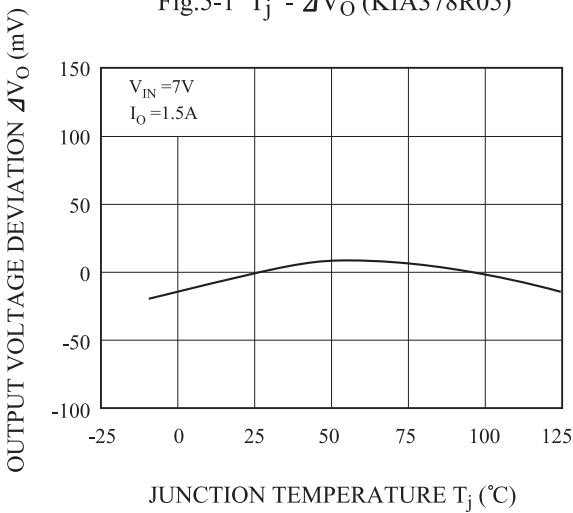

JUNCTION TEMPERATURE T_j (°C)

Fig.5-2 T_j - ΔV_O (KIA378R08)

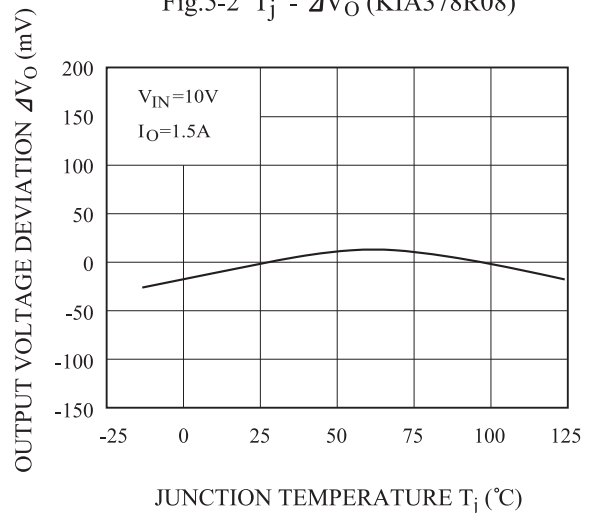

JUNCTION TEMPERATURE T_j (°C)

Fig.5-3 T_j - ΔV_O (KIA378R09)

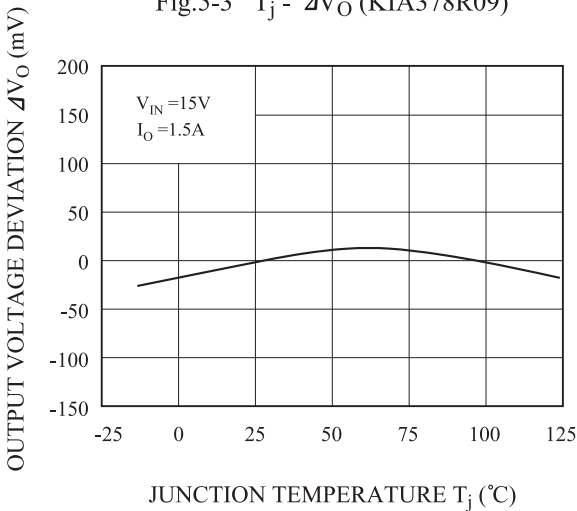

JUNCTION TEMPERATURE T_j (°C)

Fig.5-4 T_j - ΔV_O (KIA378R12)

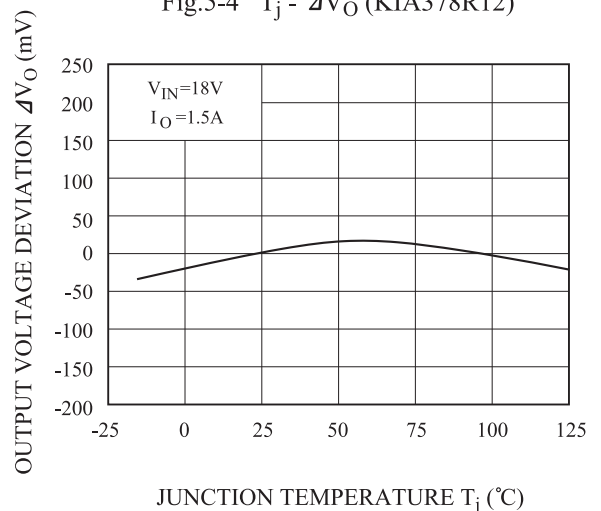

JUNCTION TEMPERATURE T_j (°C)

KIA378R05PI~KIA378R15PI

Fig.5-5 $T_j - \Delta V_O$ (KIA378R15)

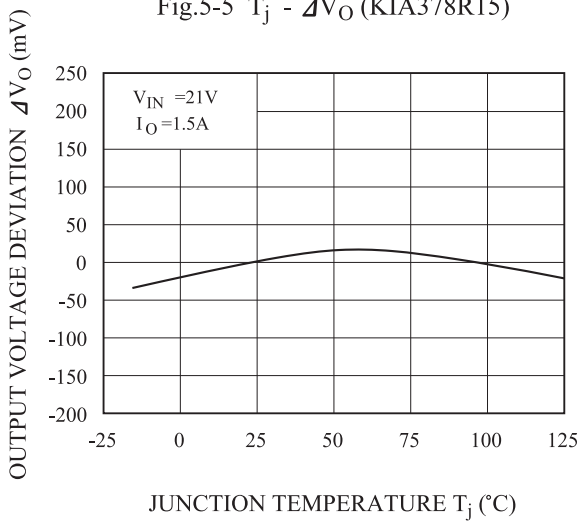

Fig.6-1 $V_{IN} - V_O$ (KIA378R05)

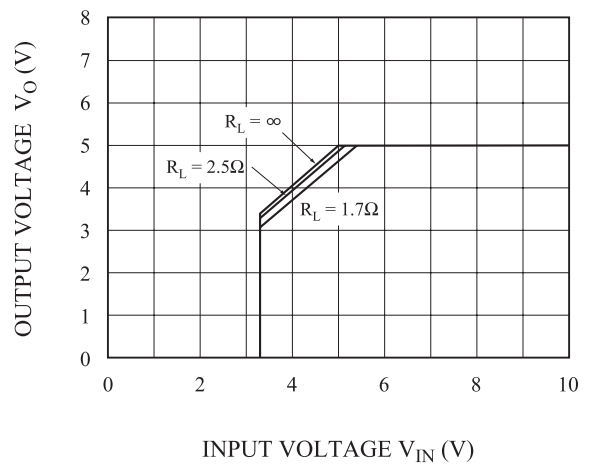

Fig.6-2 $V_{IN} - V_O$ (KIA378R08)

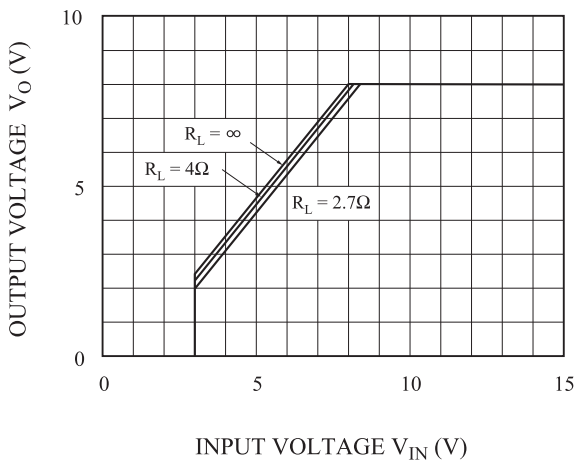

Fig.6-3 $V_{IN} - V_O$ (KIA378R09)

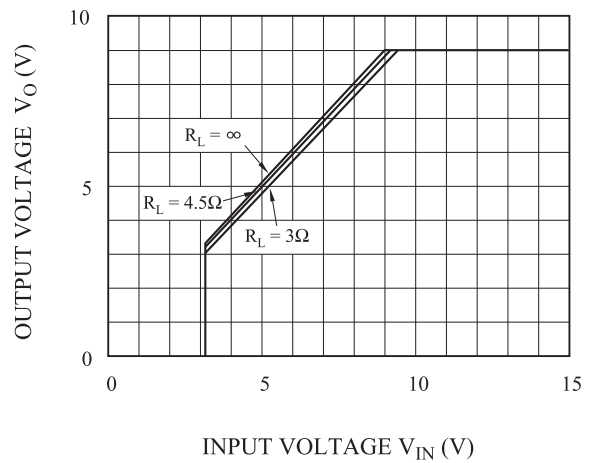

Fig.6-4 $V_{IN} - V_O$ (KIA378R12)

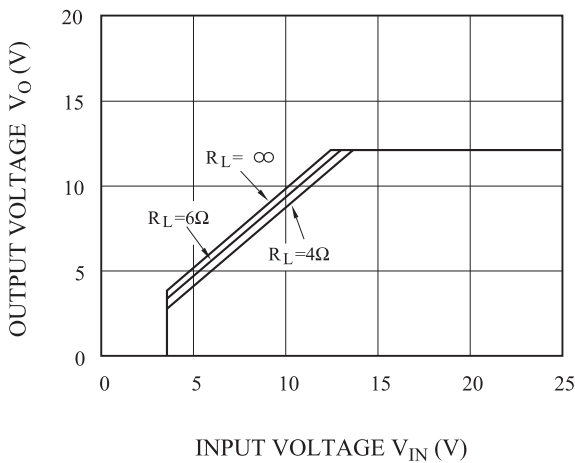
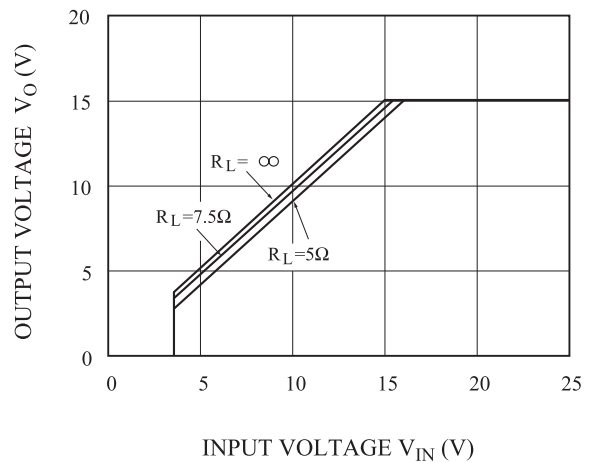

Fig.6-5 $V_{IN} - V_O$ (KIA378R15)



KIA378R05PI~KIA378R15PI

Fig.7-1 $V_{IN} - I_{BIAS}$ (KIA378R05)

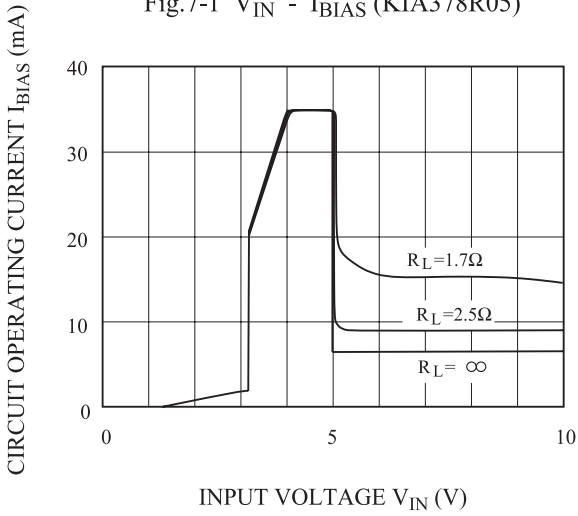

Fig.7-2 $V_{IN} - I_{BIAS}$ (KIA378R08)

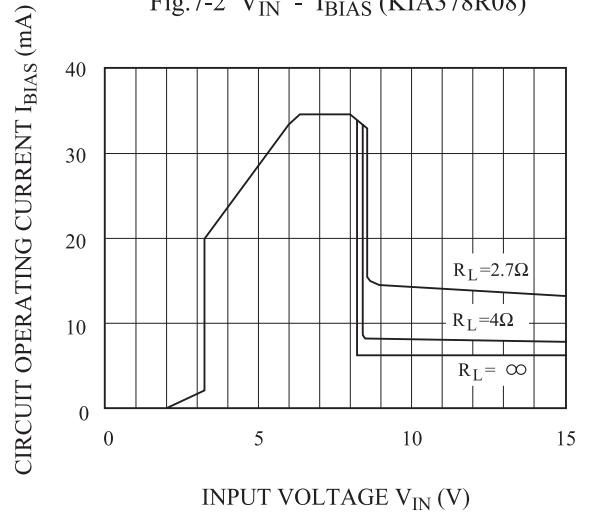

Fig.7-3 $V_{IN} - I_{BIAS}$ (KIA378R09)

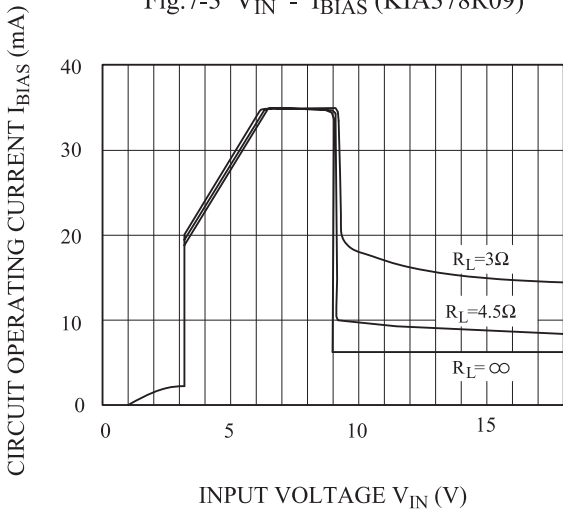

Fig.7-4 $V_{IN} - I_{BIAS}$ (KIA378R12)

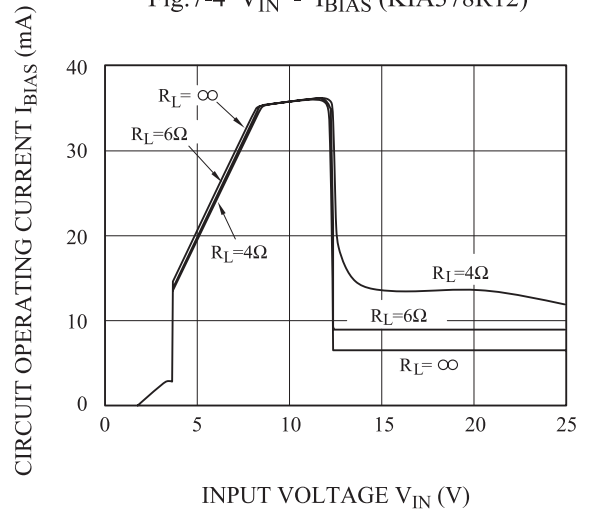

Fig.7-5 $V_{IN} - I_{BIAS}$ (KIA378R15)

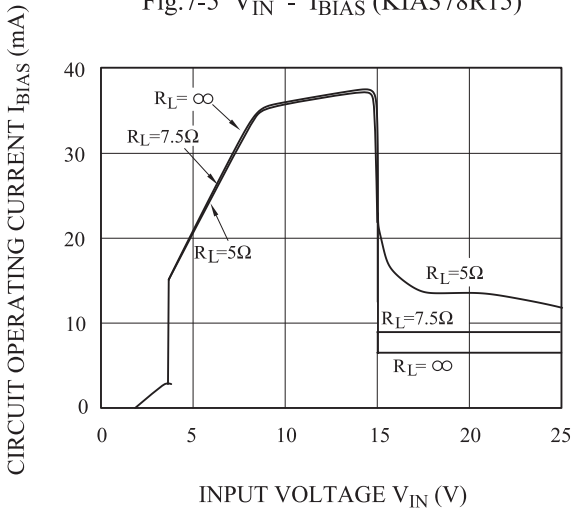
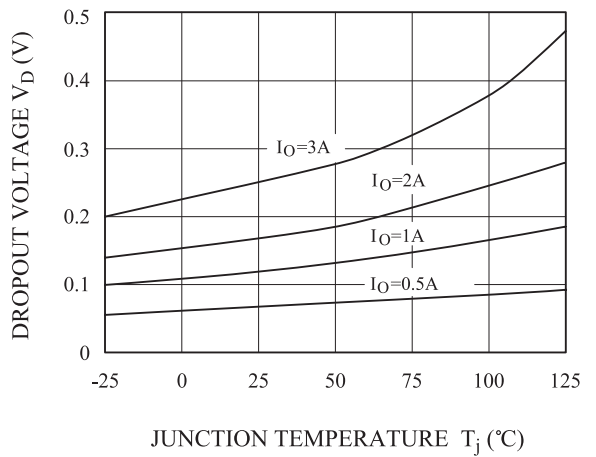

Fig.8 $T_j - V_D$



KIA378R05PI~KIA378R15PI

Fig.9 $T_j - I_q$

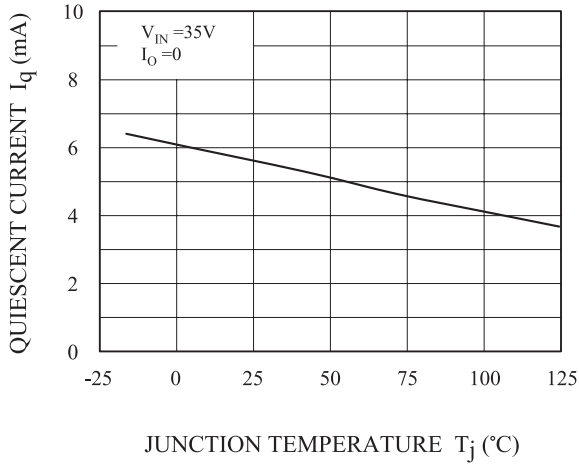

Fig. 10-1 $f - RR$

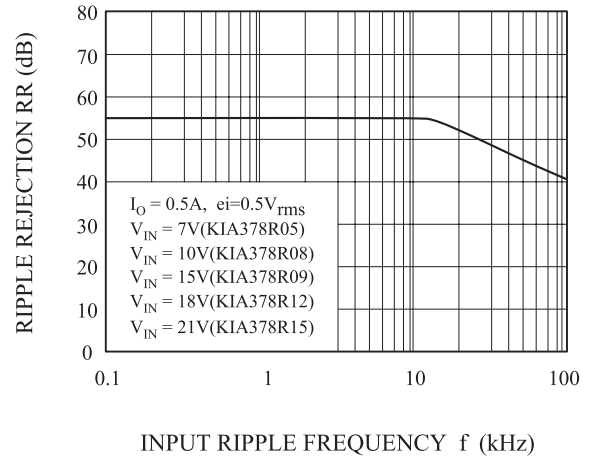

Fig.10-2 $I_O - RR$

