

Features

- Ultra-Low Phase Noise
- Variable Input Frequency 600 - 1500 MHz
- Variable Input Power from 19 - 24 dBm
- Output Harmonics to 30 GHz
- SMT680 Surface Mount Package
- SMA800 Hermetically Package
- No Bias or Tuning Required
- RoHS* Compliant

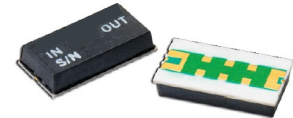

SMA800
hermetic



SMT680

Description

The MLPNC-7103 is a monolithic non-linear-transmission-line (NLTL) comb generator which offers outstanding phase noise performance. This high performance comb generator operates over specified ranges of input frequency/power.

Operating Parameters¹

Parameter	Units	Recommended Input		
		Min.	Typ.	Max.
Frequency	MHz	600	1000	1500
Power	dBm	19	22	24

1. The model MLPNC-7103 does not abruptly stop working at the recommended min and max frequencies and powers. The conversion efficiency drops outside recommended limits.

Production Test Limits²

Input / Power	Units	Output Harmonics				
		6 GHz	12 GHz	18 GHz	24 GHz	30 GHz
1000 MHz, 22 dBm	dBm	> -5	> -8	> -15	> -18	> -20

2. These are the harmonic output test limits used for production screening.

Absolute Maximum Ratings^{3,4}

Parameter	Absolute Maximum
Input Power	27 dBm
Operating Temperature	-45°C to +85°C
Storage Temperature	-55°C to +125°C
Temperature Cycling	-55°C to +125°C

3. Exceeding any one or combination of these limits may cause permanent damage to this device.
4. MACOM does not recommend sustained operation near these survivability limits.

Ordering Information

Part Number	Package
MLPNC-7103-SMA800	ESD Box with Foam
MLPNC-7103-SMT680	ESD Box with Foam

* Restrictions on Hazardous Substances, European Union Directive 2011/65/EU.

Typical Performance Curves @ +25°C using SMA package:

Harmonic Output, 600 MHz Input Frequency

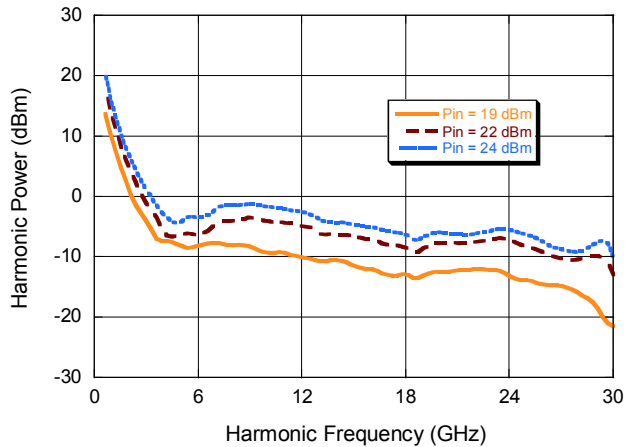

Harmonic Output, 1000 MHz Input Frequency

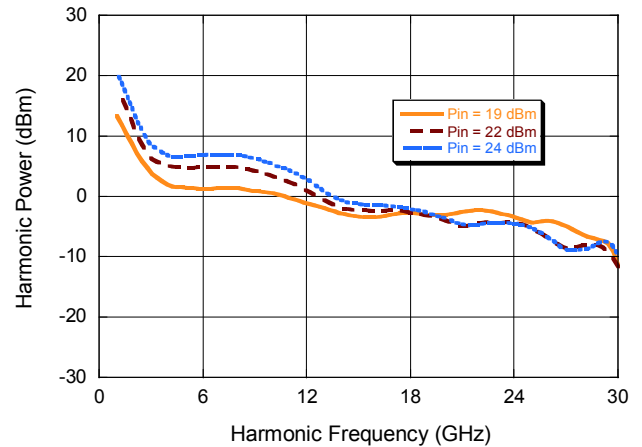

Harmonic Output, 1500 MHz Input Frequency

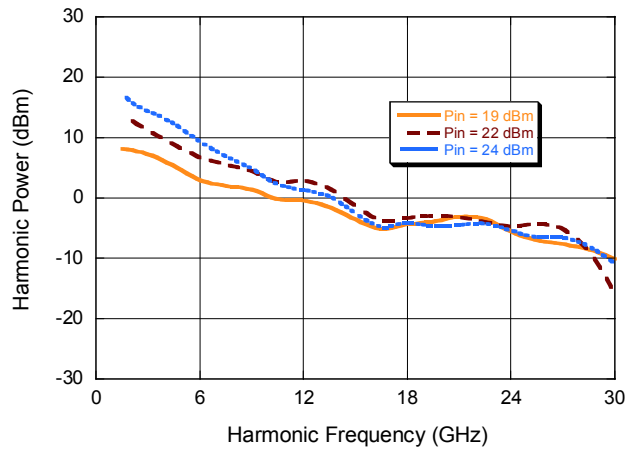

Phase Noise, 500 MHz Input Frequency, 22 dBm NLTL 24 dBm SRD

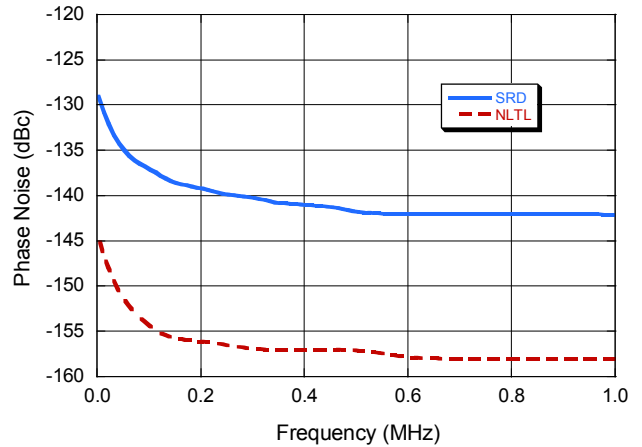

Outline: SMT680

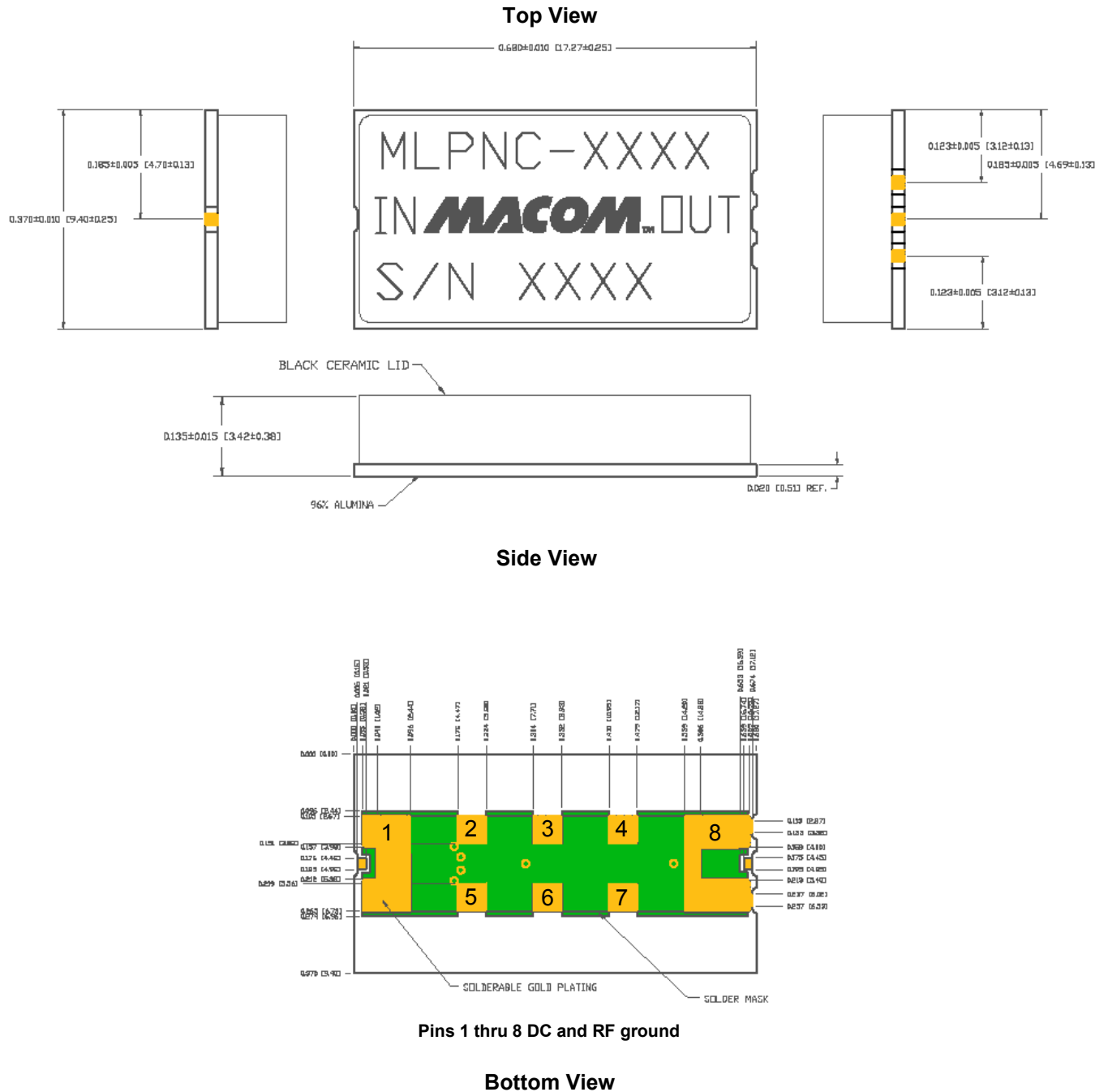

Dimensions in inches [mm]

MLPNC-7103



NLTL Comb Generator

Rev. V2

Outline: SMA800, hermetic

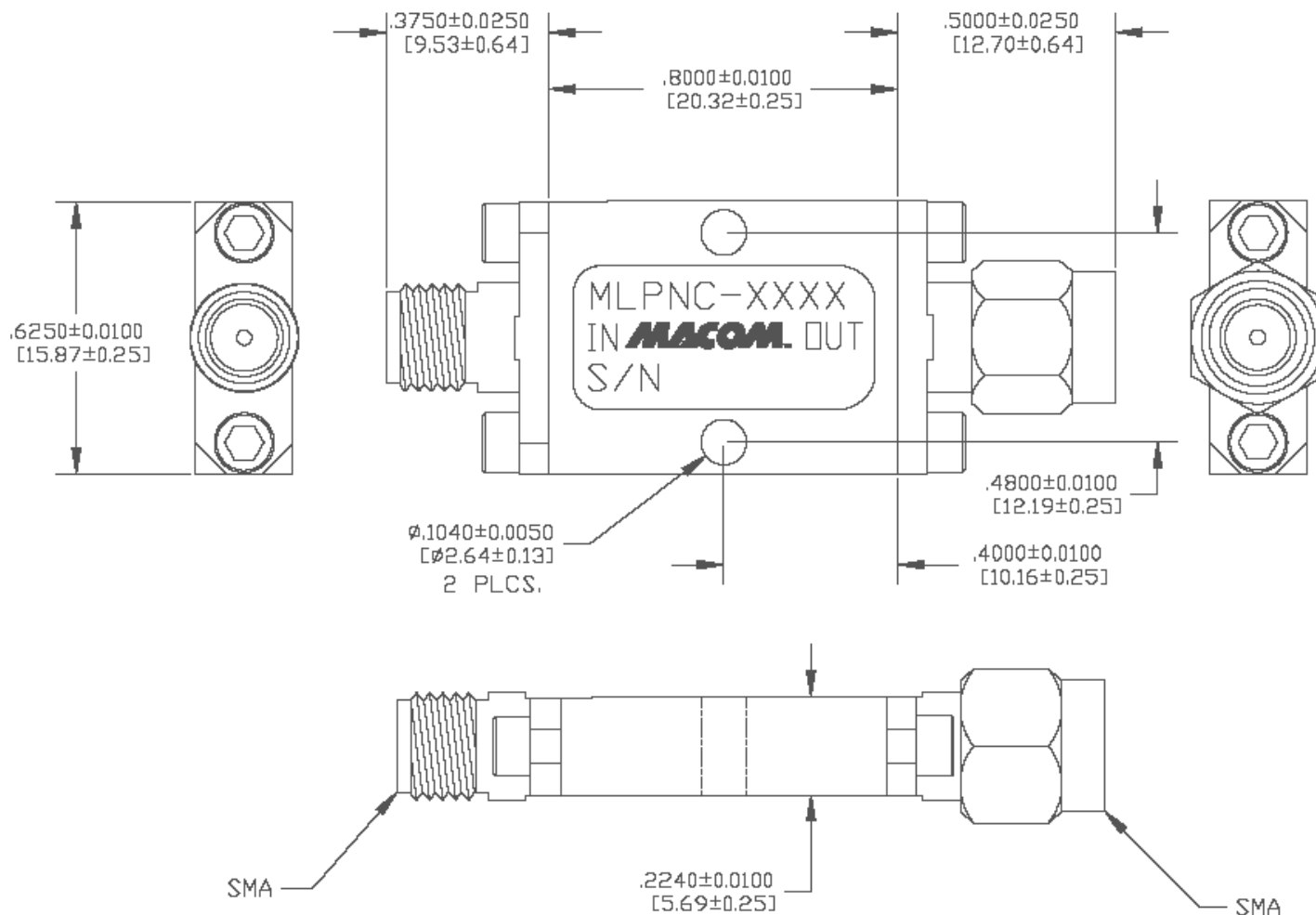

Dimensions in inches [mm]

M/A-COM Technology Solutions Inc. All rights reserved.

Information in this document is provided in connection with M/A-COM Technology Solutions Inc ("MACOM") products. These materials are provided by MACOM as a service to its customers and may be used for informational purposes only. Except as provided in MACOM's Terms and Conditions of Sale for such products or in any separate agreement related to this document, MACOM assumes no liability whatsoever. MACOM assumes no responsibility for errors or omissions in these materials. MACOM may make changes to specifications and product descriptions at any time, without notice. MACOM makes no commitment to update the information and shall have no responsibility whatsoever for conflicts or incompatibilities arising from future changes to its specifications and product descriptions. No license, express or implied, by estoppel or otherwise, to any intellectual property rights is granted by this document.

THESE MATERIALS ARE PROVIDED "AS IS" WITHOUT WARRANTY OF ANY KIND, EITHER EXPRESS OR IMPLIED, RELATING TO SALE AND/OR USE OF MACOM PRODUCTS INCLUDING LIABILITY OR WARRANTIES RELATING TO FITNESS FOR A PARTICULAR PURPOSE, CONSEQUENTIAL OR INCIDENTAL DAMAGES, MERCHANTABILITY, OR INFRINGEMENT OF ANY PATENT, COPYRIGHT OR OTHER INTELLECTUAL PROPERTY RIGHT. MACOM FURTHER DOES NOT WARRANT THE ACCURACY OR COMPLETENESS OF THE INFORMATION, TEXT, GRAPHICS OR OTHER ITEMS CONTAINED WITHIN THESE MATERIALS. MACOM SHALL NOT BE LIABLE FOR ANY SPECIAL, INDIRECT, INCIDENTAL, OR CONSEQUENTIAL DAMAGES, INCLUDING WITHOUT LIMITATION, LOST REVENUES OR LOST PROFITS, WHICH MAY RESULT FROM THE USE OF THESE MATERIALS.

MACOM products are not intended for use in medical, lifesaving or life sustaining applications. MACOM customers using or selling MACOM products for use in such applications do so at their own risk and agree to fully indemnify MACOM for any damages resulting from such improper use or sale.