

SYM	ECN No.	MODIFICATION	DATE	ISSUED

Note:

1. Material:

- 1.1, Housing: High temperature thermoplastic with/black g.f, UL94v-0
- 1.2, Contact: copper alloy, t=0.25mm
- 1.3, Shell: copper/Ferroalloy alloy, t=0.30mm

2. Specification:

- 2.1, Current rating: 3A Max.
- 2.2, Dielectric withstanding voltage: 100 V(ac) for 1 min.
- 2.3, Contact resistance: 30 mΩ Max.
- 2.4, Insulation resistance: 100 MΩ Min.
- 2.5, Total mating force: 3.57 Kgf Max.
- 2.6, Total unmating force: 1.0 Kgf Min.

3. Finish:

- 3.1, Contact: Plated Gold in Mating Area:
Tin On Solder Talls
Shell: Nickel Plating

4. Environmental:

- 4.1, Temperature range: -55°C~85°C

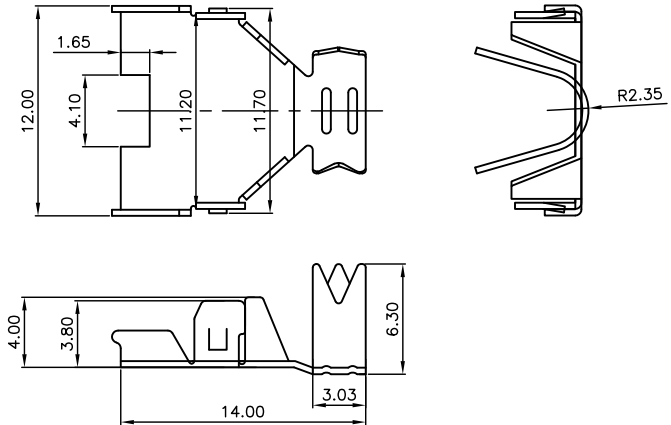
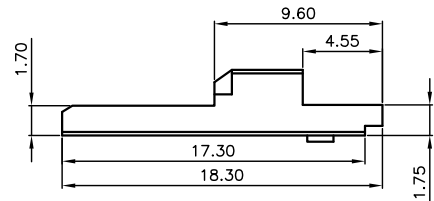
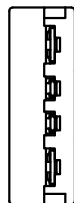
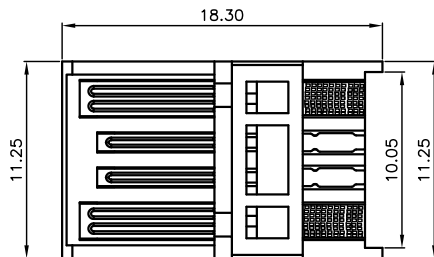
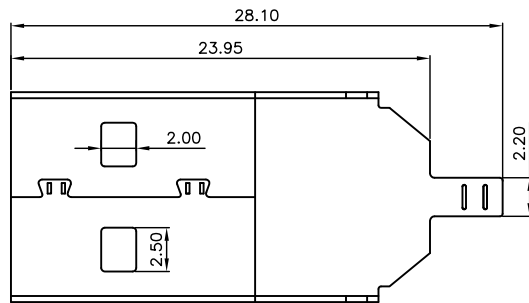
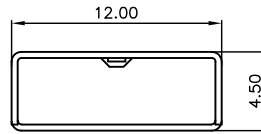
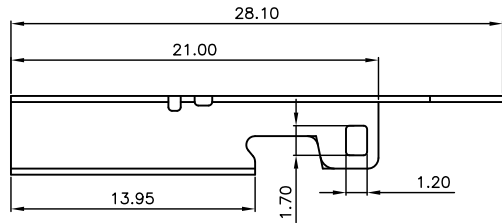

DRAWN		JTJ 深圳市精拓金电子有限公司			
CHECKED		TITLE		PART NO.	
APPROVED		AM大电流三件式铁壳 PBT绿色0D4.0		917-701A109DM0400	
3rd ANGLE PROJECTION		TOLERANCE		SCALE	SHEET
UNIT		.XXX±.10, .XX±.15, .X±.25, ANG±1°		1:1	1 OF 1
mm				SIZE	REV.
				A4	X1
				DRAWING NO. --	