

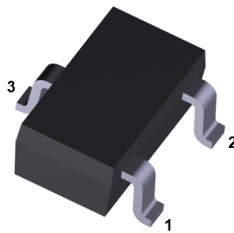

Automotive transient voltage suppressor (TVS) in SOT23-3L

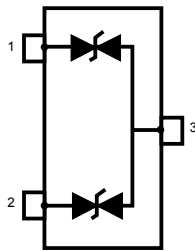

SOT23-3L
(Jedec TO-236)



Features

- AEC-Q101 qualified 
- Dual-line ESD and EOS protection
- Bidirectional device
- Max. pulse power: 140 W (8/20 μ s)
- Low clamping factor V_{CL}/V_{BR}
- Low leakage current
- ECOPACK[®]2 compliant
- Complies with the standard ISO 10605 - C = 150 pF, R = 330 Ω
 - ± 13 kV (air discharge)
 - ± 13 kV (contact discharge)
- Complies with the standard ISO 10605 - C = 330 pF, R = 330 Ω
 - ± 10 kV (air discharge)
 - ± 10 kV (contact discharge)
- Complies with the standard ISO 10605 - C = 330 pF, R = 2 k Ω
 - ± 30 kV (air discharge)
 - ± 30 kV (contact discharge)
- Complies with the standard ISO 7637-3
 - Fast transient pulse 3a: $V_s = -150$ V
 - Fast transient pulse 3b: $V_s = +150$ V
 - Slow transient pulse 2a: $V_s = -85$ V
 - Slow transient pulse 2a: $V_s = +85$ V

Product status link

[ESDAVLC6-2BLY](#)

Product summary

Order code	ESDAVLC6-2BLY
Package	SOT23-3L
Packing	Tape and reel

Application

- Automotive interfaces

Description

The **ESDAVLC6-2BLY** is a dual-line Transil specifically designed for the protection of the automotive buses lines against electrostatic discharge (ESD). Thanks to its low capacitance, this product is compliant with all key interfaces in automotive applications.

1 Characteristics

Table 1. Absolute ratings ($T_{amb} = 25\text{ }^{\circ}\text{C}$)

Symbol	Parameter	Value	Unit	
V_{PP}	Peak pulse voltage	ISO 10605 - C = 150 pF, R = 330 Ω :	kV	
		Contact discharge		13
		Air discharge		13
		ISO 10605 - C = 330 pF, R = 330 Ω :		10
		Contact discharge		
		Air discharge		
ISO 10605 - C = 330 pF, R = 2 k Ω :	30			
Contact discharge				
Air discharge				
P_{PP}	Peak pulse power dissipation (8/20 μs) T_j initial = T_{amb}	140	W	
I_{PP}	Peak pulse current (8/20 μs)	5.5	A	
T_j	Operating junction temperature range	-55 to +150	$^{\circ}\text{C}$	
T_{stg}	Storage temperature range	-55 to +150	$^{\circ}\text{C}$	

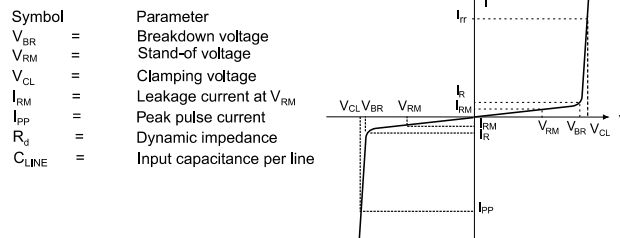
Figure 1. Electrical characteristics (definitions)

Table 2. Electrical characteristics (values, $T_{amb} = 25\text{ }^{\circ}\text{C}$)

Symbol	Test conditions	Min.	Typ.	Max.	Unit
V_{BR}	$I_R = 1\text{ mA}$	6		10	V
I_R	$V_{RM} = 5\text{ V}$			100	nA
V_{CL}	At $I_{PP} = 1\text{ A}$ - 8/20 μs			12	V
	At $I_{PP} = 4\text{ A}$ - 8/20 μs			17	
$C_{I/O-GND}$	$V_{I/O} = 0\text{ V}$, $f = 1\text{ MHz}$, $V_{OSC} = 30\text{ mV}$		0.95	1.2	pF
$\Delta C_{I/O-GND}$			0.01		
f_C	$S_{21} = -3\text{ dB}$		3		GHz
$\alpha T^{(1)}$			9		$10^{-4}/^{\circ}\text{C}$

 1. V_{BR} at $T_j = V_{BR}$ at $25\text{ }^{\circ}\text{C} \times (1 + \alpha T \times (T_j - 25))$

1.1 Characteristics (curves)

Figure 2. Leakage current versus junction temperature

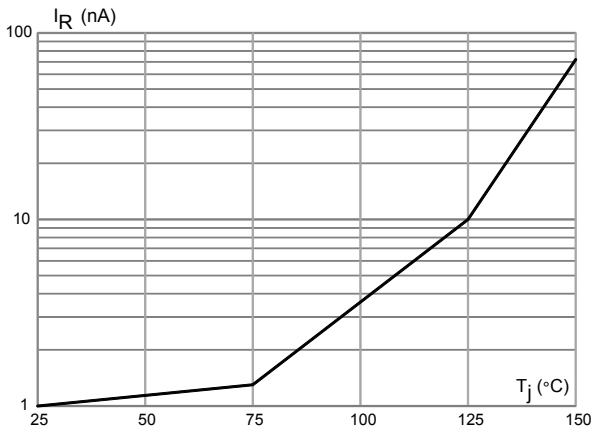

Figure 3. Junction capacitance versus reverse applied voltage

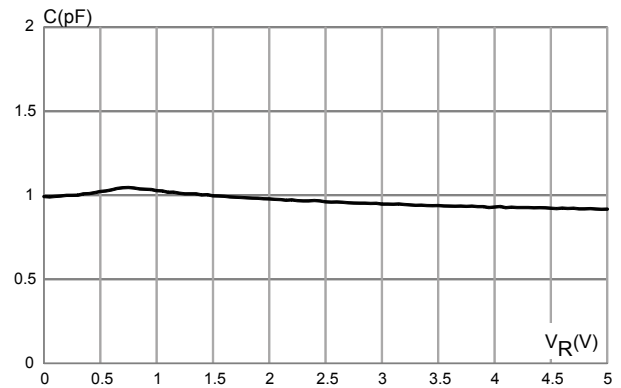

Figure 4. ESD response to ISO10605-C = 150 pF, R = 330 Ω (+8 kV contact discharge)



Figure 5. ESD response to ISO10605-C = 150 pF, R = 330 Ω (-8 kV contact discharge)



Figure 6. TLP

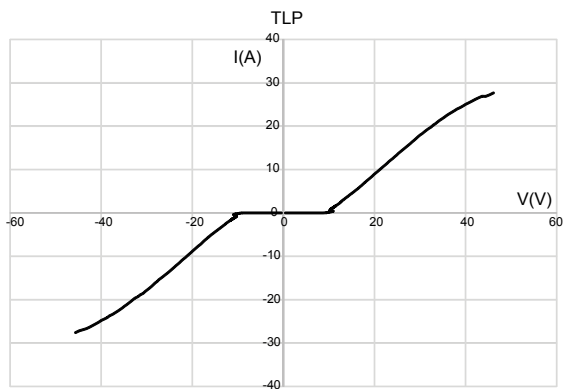

Figure 7. S₂₁ attenuation

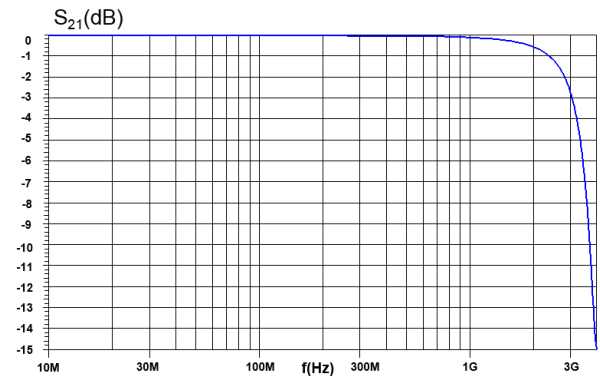
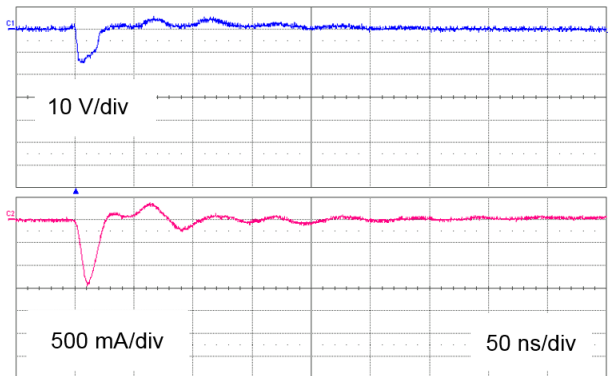
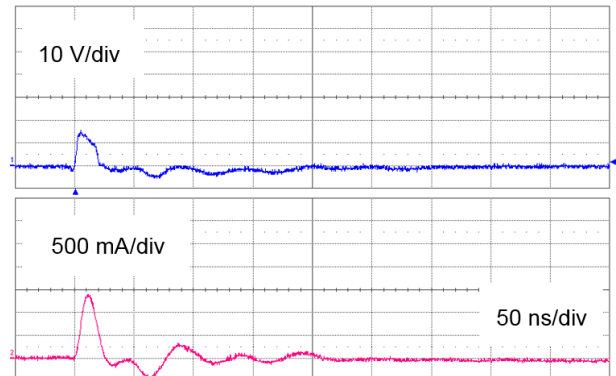
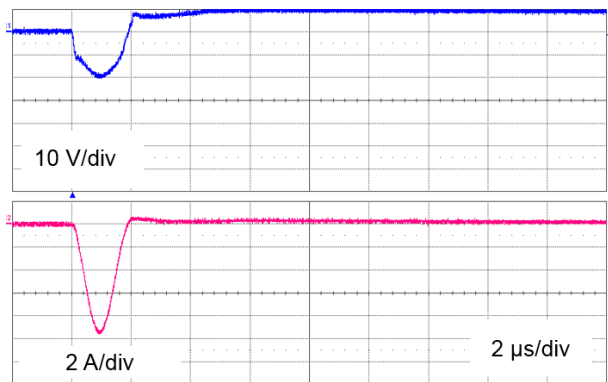
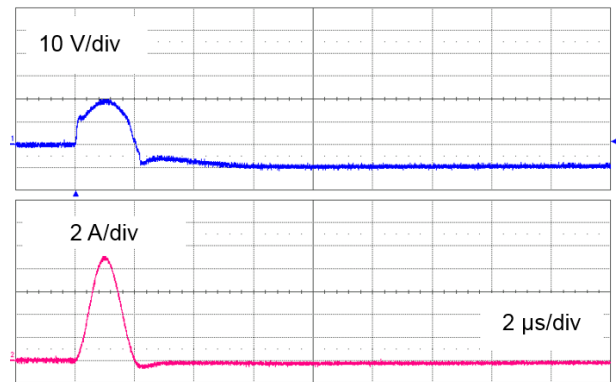

Figure 8. Fast transient pulse 3a ($U_s = -150\text{ V}$)

Figure 9. Fast transient pulse 3b ($U_s = +150\text{ V}$)

Figure 10. Slow transient pulse 2a ($U_s = -85\text{ V}$)

Figure 11. Slow transient pulse 2a ($U_s = +85\text{ V}$)

2 Package information

In order to meet environmental requirements, ST offers these devices in different grades of **ECOPACK®** packages, depending on their level of environmental compliance. ECOPACK® specifications, grade definitions and product status are available at: www.st.com. ECOPACK® is an ST trademark.

2.1 SOT23-3L package information

Figure 12. SOT23-3L package outline

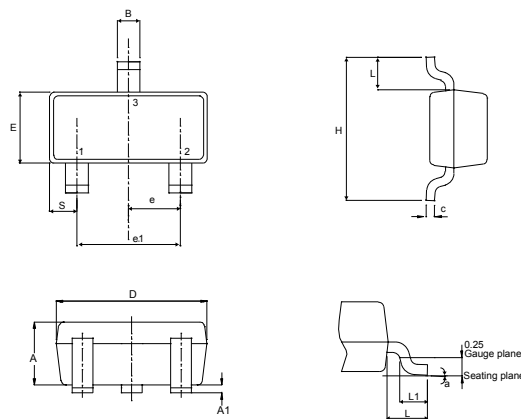

Table 3. SOT23-3L package mechanical data

Ref.	Dimensions					
	Millimeters			Inches ⁽¹⁾		
	Min.	Typ.	Max.	Min.	Typ.	Max.
A	0.89		1.40	0.0350		0.0551
A1	0.00		0.10	0.0000		0.0039
B	0.30		0.51	0.0118		0.0201
C	0.085		0.18	0.0033		0.0071
D	2.75		3.04	0.1083		0.1197
e	0.85		1.05	0.0335		0.0413
e1	1.70		2.10	0.0669		0.0827
E	1.20		1.75	0.0472		0.0689
H	2.10		3.00	0.0827		0.1181
L		0.60			0.0236	
S	0.35		0.65	0.0138		0.256
L1	0.25		0.55	0.0098		0.0217
a	0°		8°	0°		8°

1. Dimension in inches are given for reference only.

Figure 13. SOT23-3L marking

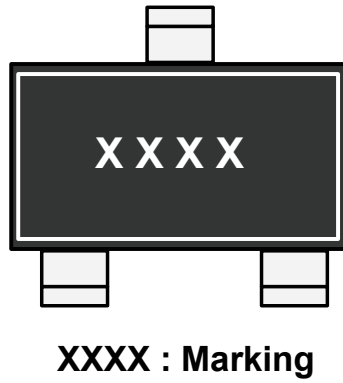

Figure 14. SOT23-3L footprint in mm (inches)

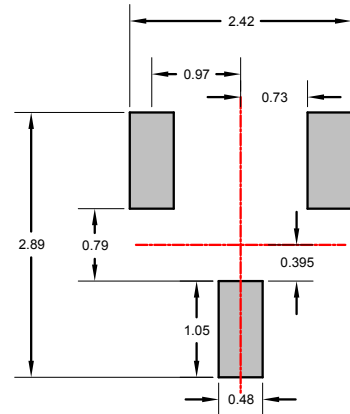
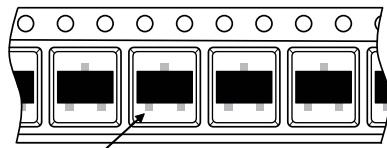

Figure 15. Package orientation in reel



Pin 1 located according to EIA-481

Note: Pocket dimensions are not on scale
Pocket shape may vary depending on package

Figure 16. Tape and reel orientation

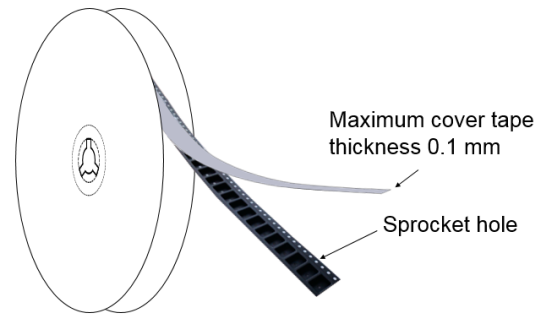

Figure 17. 7" reel dimension values

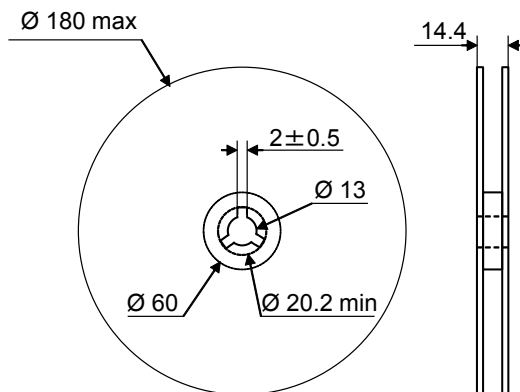

Figure 18. Inner box dimension values

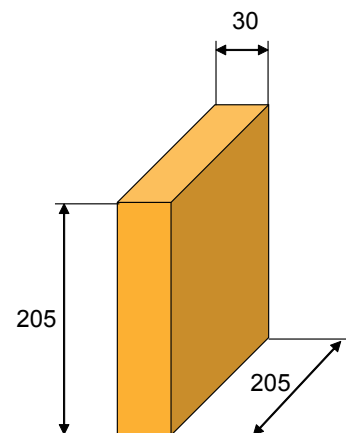
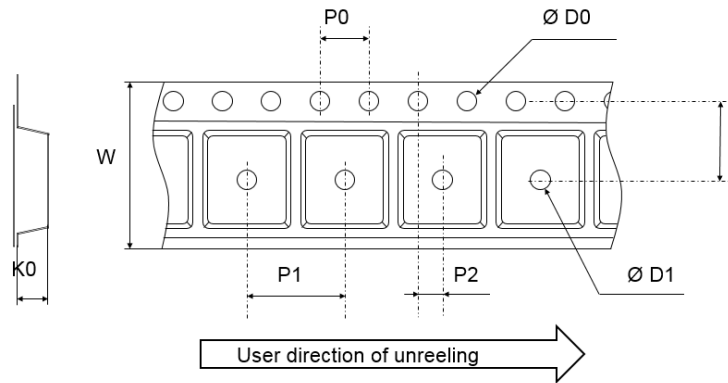

Figure 19. Tape outline



Note: Pocket dimensions are not on scale
Pocket shape may vary depending on package

Table 4. Tape dimension values

Ref.	Dimensions		
	Millimeters		
	Min.	Typ.	Max.
D0	1.45	1.5	1.6
D1	1		
F	3.45	3.5	3.55
K0	1.3	1.4	1.5
P0	3.9	4.0	4.1
P1	3.9	4.0	4.1
P2	1.95	2.0	2.05
W	7.9	8	8.3

2.3 Reflow profile

Figure 20. ST ECOPACK® recommended soldering reflow profile for PCB mounting

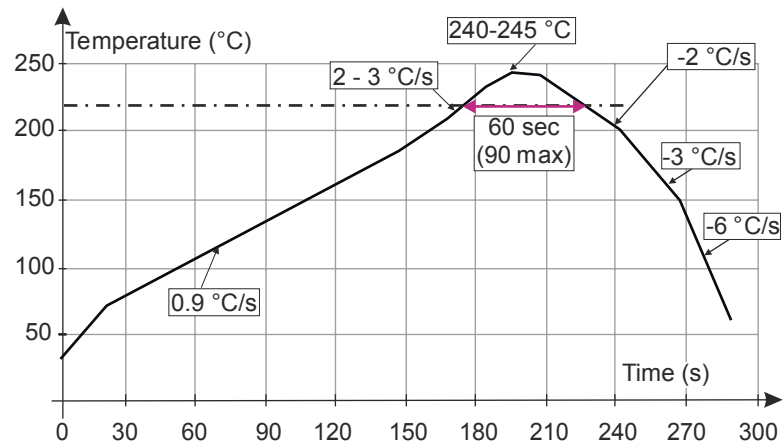

Note: Minimize air convection currents in the reflow oven to avoid component movement. Maximum soldering profile corresponds to the latest IPC/JEDEC J-STD-020.

3 Ordering information

Figure 21. Ordering information scheme

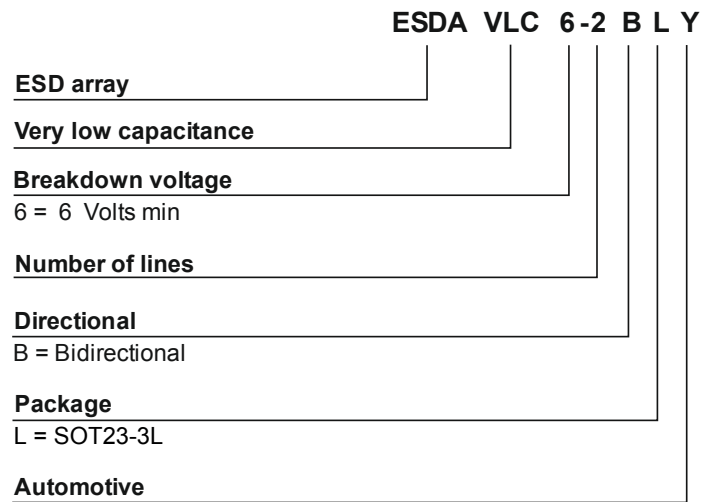

Table 5. Ordering information

Order code	Marking	Package	Weight	Base qty.	Delivery mode
ESDAVLC6-2BLY	C06Y	SOT23-3L	10 mg	3000	Tape and reel

Revision history

Table 6. Document revision history

Date	Version	Changes
28-Sep-2018	1	Initial release.
18-Oct-2018	2	Updated Table 2. Electrical characteristics (values, $T_{amb} = 25\text{ °C}$).

IMPORTANT NOTICE – PLEASE READ CAREFULLY

STMicroelectronics NV and its subsidiaries (“ST”) reserve the right to make changes, corrections, enhancements, modifications, and improvements to ST products and/or to this document at any time without notice. Purchasers should obtain the latest relevant information on ST products before placing orders. ST products are sold pursuant to ST’s terms and conditions of sale in place at the time of order acknowledgement.

Purchasers are solely responsible for the choice, selection, and use of ST products and ST assumes no liability for application assistance or the design of Purchasers’ products.

No license, express or implied, to any intellectual property right is granted by ST herein.

Resale of ST products with provisions different from the information set forth herein shall void any warranty granted by ST for such product.

ST and the ST logo are trademarks of ST. All other product or service names are the property of their respective owners.

Information in this document supersedes and replaces information previously supplied in any prior versions of this document.

© 2018 STMicroelectronics – All rights reserved