



# C2C-SA06010A10000, C2C-EA06010A10000

deTec2 Core

**SAFETY LIGHT CURTAINS**

**SICK**  
Sensor Intelligence.



### Ordering information

System part	Type	Part no.
Sender	C2C-SA06010A10000	1213191
Receiver	C2C-EA06010A10000	1213192

Other models and accessories → [www.sick.com/deTec2\\_Core](http://www.sick.com/deTec2_Core)



### Detailed technical data

#### Features

<b>System part</b>	Sender/receiver pair with QuickFix bracket
<b>Resolution</b>	14 mm
<b>Protective field height</b>	600 mm
<b>Scanning range</b>	Minimum 0 m ... 7 m
	Typical 0 m ... 8 m
<b>Response time</b>	13 ms
<b>Synchronization</b>	Optical synchronisation

#### Safety-related parameters

<b>Type</b>	Type 2 (IEC 61496)
<b>Safety integrity level</b>	SIL1 (IEC 61508) SILCL1 (EN 62061)
<b>Category</b>	Category 2 (EN ISO 13849)
<b>Performance level</b>	PL c (EN ISO 13849)
<b>PFH<sub>D</sub> (mean probability of a dangerous failure per hour)</b>	$3.1 \times 10^{-8}$ (EN ISO 13849)
<b>T<sub>M</sub> (mission time)</b>	20 years (EN ISO 13849)
<b>Safe state in the event of a fault</b>	At least one OSSD is in the OFF state.

#### Interfaces

<b>System connection</b>	Connection type	Male connector M12, 5-pin
	Permitted cable length	≤ 50 m
<b>Fieldbus, industrial network</b>		
Integration via Flexi Soft safety controller		CANopen, DeviceNet™, EtherCAT®, EtherNet/IP™, Modbus TCP, PROFIBUS DP, PROFINET <sup>1)</sup>

<sup>1)</sup> For additional information on Flexi Soft -> [www.sick.com/Flexi\\_Soft](http://www.sick.com/Flexi_Soft).

## Electrical data

<b>Protection class</b>	III (EN 50178)
<b>Supply voltage <math>V_S</math></b>	24 V DC (19.2 V ... 28.8 V)
<b>Ripple</b>	$\leq 2.4 V_{pp}^{1)}$
<b>Power consumption typical</b>	2.4 W (DC) / 1.2 W (DC) (depending on type)
<b>Safety outputs (OSSD)</b>	
Type of output	2 PNP semiconductors, short-circuit protected, cross-circuit monitored <sup>2)</sup>
Switching voltage HIGH	24 V DC ( $V_S - 2.25$ V DC ... $V_S$ )
Switching voltage LOW	$\leq 2$ V DC
Switching current	$\leq 300$ mA

<sup>1)</sup> Within the limits of  $V_S$ .

<sup>2)</sup> Applies to the voltage range between -30 V and +30 V.

## Mechanical data

<b>Housing cross-section (incl. system connection)</b>	34 mm x 30.7 mm
<b>Housing material</b>	Aluminum extruded profile
<b>Weight</b>	580 g / 570 g (depending on type)

## Ambient data

<b>Enclosure rating</b>	IP65 (EN 60529) IP67 (EN 60529)
<b>Ambient operating temperature</b>	-30 °C ... +55 °C
<b>Storage temperature</b>	-30 °C ... +70 °C
<b>Air humidity</b>	15 % ... 95 %, Non-condensing
<b>Vibration resistance</b>	5 g, 10 Hz ... 55 Hz (EN 60068-2-6)
<b>Shock resistance</b>	10 g, 16 ms (EN 60068-2-29)

## Other information

<b>Wave length</b>	850 nm
--------------------	--------

## Classifications

<b>ECl@ss 5.0</b>	27272704
<b>ECl@ss 5.1.4</b>	27272704
<b>ECl@ss 6.0</b>	27272704
<b>ECl@ss 6.2</b>	27272704
<b>ECl@ss 7.0</b>	27272704
<b>ECl@ss 8.0</b>	27272704
<b>ECl@ss 8.1</b>	27272704
<b>ECl@ss 9.0</b>	27272704
<b>ETIM 5.0</b>	EC002549
<b>ETIM 6.0</b>	EC002549
<b>UNSPSC 16.0901</b>	46171620

Dimensional drawing (Dimensions in mm (inch))

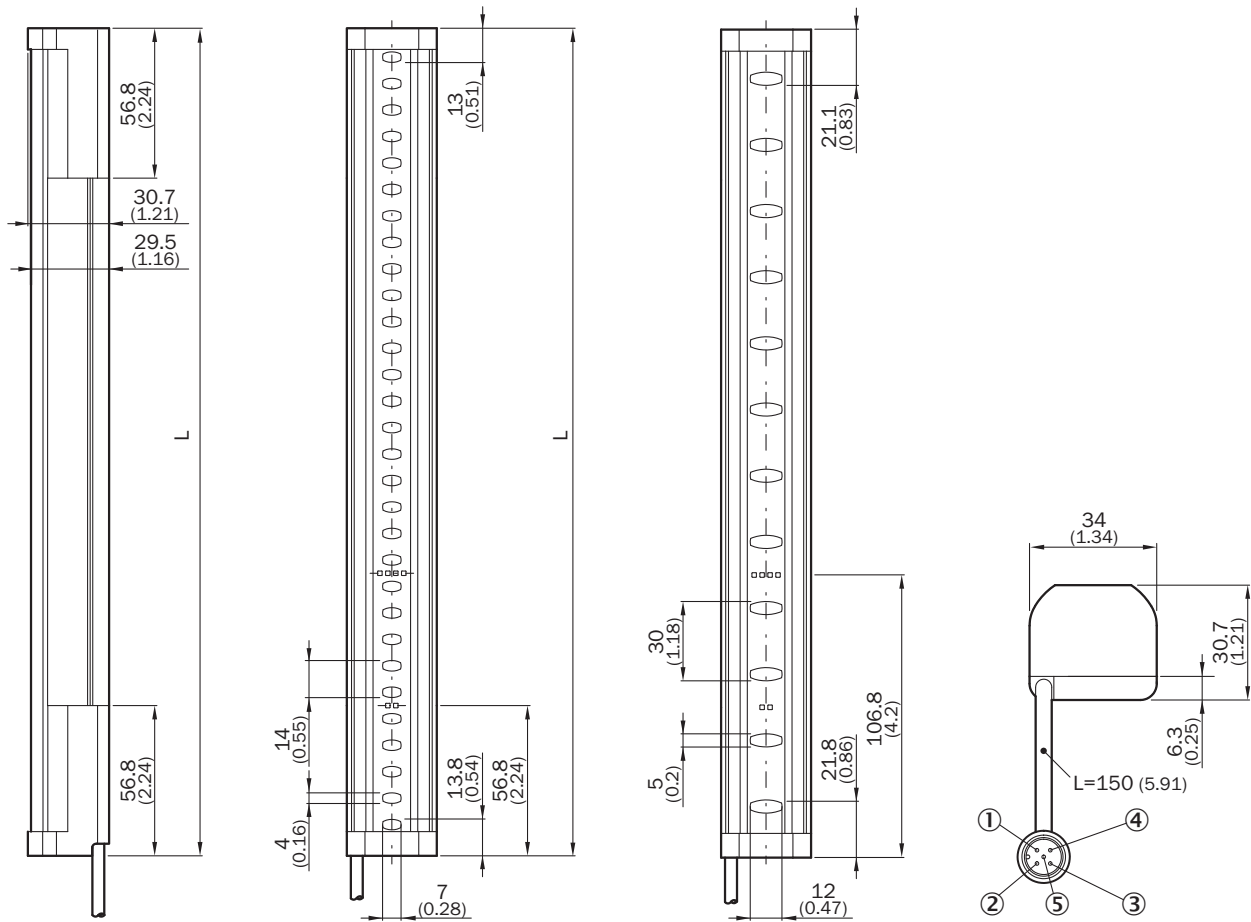

Protective field height	L
300 (11.81)	313 (12.32)
450 (17.72)	463 (18.23)
600 (23.62)	613 (24.13)
750 (29.53)	763 (30.04)
900 (35.43)	913 (35.94)
1,050 (41.34)	1,063 (41.85)
1,200 (47.24)	1,213 (47.76)
1,350 (53.15)	1,362 (53.62)
1,500 (59.06)	1,512 (59.53)
1,650 (64.96)	1,662 (65.43)
1,800 (70.87)	1,812 (71.34)
1,950 (76.77)	1,962 (77.24)
2,100 (82.68)	2,112 (83.15)

## Connection diagram

deTec2 Core safety light curtain connected to UE48-20S safety relay

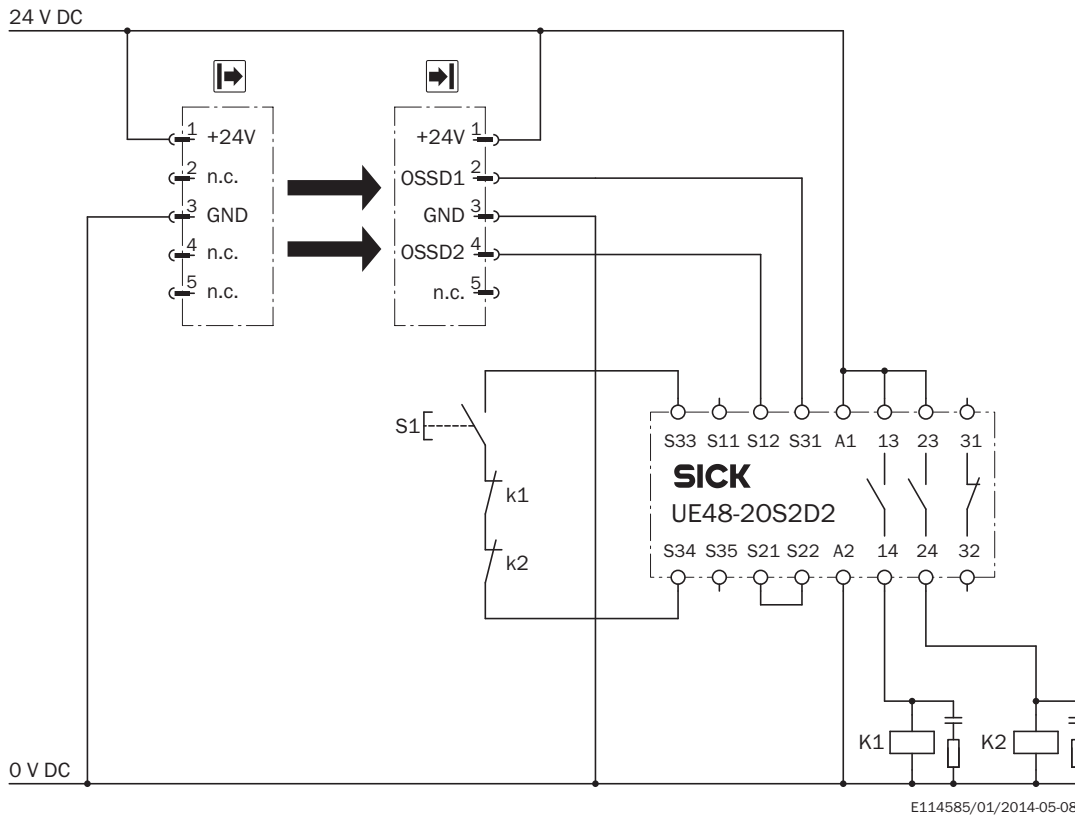

### Task

Connection of a deTec2 Core safety light curtain to UE48-20S.

Operating mode: with restart interlock and external device monitoring.

### Function

When the light path is clear, the OSSD1 and OSSD2 outputs are live. The system is ready to switch on if K1 and K2 are de-energized. By pressing S1 (button is pressed and released), the UE48-20S is energized and its 13 - 14 and 23 - 24 contacts activate K1 and K2. On interruption of one of the light beams, the UE48-20S is de-energized by the OSSD1 and OSSD2 outputs and K1 and K2 are deactivated.

### Fault analysis

OSSD cross-circuits and short-circuits are detected and lead to the inhibited state (lock-out). The incorrect functioning of one of the K1 or K2 contactors will be detected and does not result in the loss of the shutdown function. Jamming of the S1 button will prevent the UE48-20S from enabling.

### Comments

<sup>1)</sup> Output circuits: These contacts are to be connected to the controller such that, with the output circuit open, the dangerous state is disabled. For categories 4 and 3, the integration must be dual-channel (x/y paths). Single-channel integration in the control (z path) is only possible with a single-channel control and by taking the risk analysis into account.

## SICK AT A GLANCE

SICK is one of the leading manufacturers of intelligent sensors and sensor solutions for industrial applications. A unique range of products and services creates the perfect basis for controlling processes securely and efficiently, protecting individuals from accidents and preventing damage to the environment.

We have extensive experience in a wide range of industries and understand their processes and requirements. With intelligent sensors, we can deliver exactly what our customers need. In application centers in Europe, Asia and North America, system solutions are tested and optimized in accordance with customer specifications. All this makes us a reliable supplier and development partner.

Comprehensive services complete our offering: SICK LifeTime Services provide support throughout the machine life cycle and ensure safety and productivity.

For us, that is “Sensor Intelligence.”

## WORLDWIDE PRESENCE:

Contacts and other locations –[www.sick.com](http://www.sick.com)