

RF ADAPTERS



- Adapters can be connected between each series.
- 2 or more port are available and mechanical characteristics are defined by mating connectors.

(NOTE) The listed combination of the adapters are common types.
If you look for other combination, please contact our sales office.

▶ N to N

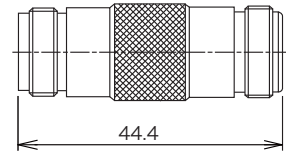
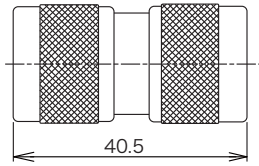

Part Number	Finish	
	Outer Conductor	Center Conductor
N-A-PP-1-CF	Ag	Ag
N-A-PP-1-Ni-CF	Ni	Ag

Part Number	Finish	
	Outer Conductor	Center Conductor
N-A-JJ-CF	Ag	Ag
N-A-JJ-NiCAu-CF	Ni	Au
N-A-JJ-Ni-1-CF	Ni	Ag
UG-29B/U-CF	Ag	Ag

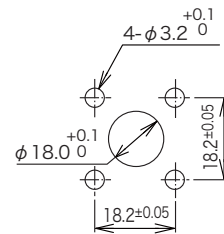
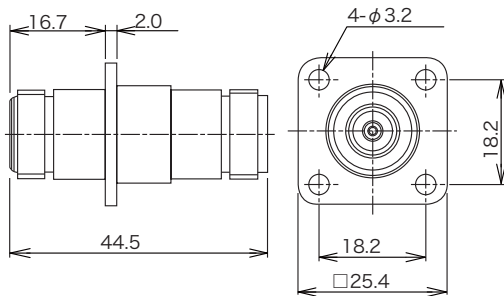

Panel Mounting Dimensions

Part Number	Finish	
	Outer Conductor	Center Conductor
N-PA-JJ-CF	Ag	Ag
N-PA-JJ-CAu-CF	Ni	Au
N-PA-JJ-Ni-CF	Ni	Ag
N-PA-JJ-SUS-CF	SUS	Ag

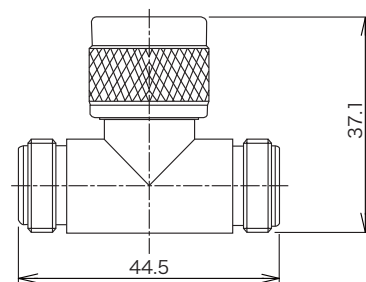
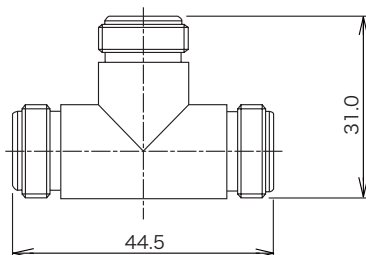

Part Number	Finish	
	Outer Conductor	Center Conductor
N-TA-JJJ-CF	Ag	Ag
N-TA-JJJ-Ni-CF	Ni	Ag

Part Number	Finish	
	Outer Conductor	Center Conductor
N-TA-JPJ-CF	Ag	Ag
N-TA-JPJ-Ni-CF	Ni	Ag

© Specifications and/or dimensions in this catalog are subject to change without notice.
Your checking the latest specifications with our drawings would be highly appreciated.

▶ N to N

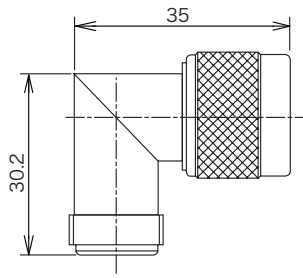

Part Number	Finish	
	Outer Conductor	Center Conductor
N-LA-PJ-CF	Ag	Ag
N-LA-PJ-Ni-CF	Ni	Ag

▶ N to BNC

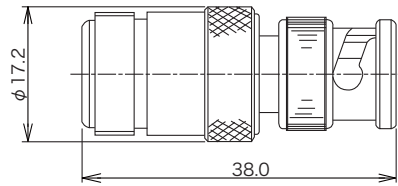
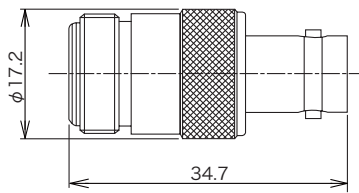

Part Number	Finish	
	Outer Conductor	Center Conductor
NJ-BNCJ-CF	Ag	Ag

Part Number	Finish	
	Outer Conductor	Center Conductor
NJ-BNCP-CF	Ag	Ag

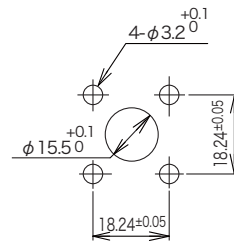
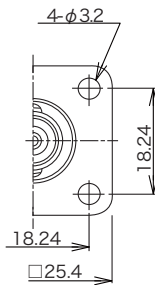
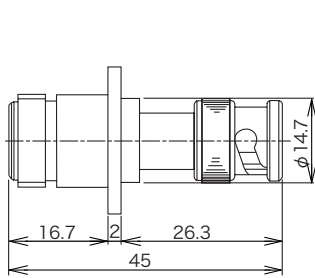

Panel Mounting Dimensions

Part Number	Finish	
	Outer Conductor	Center Conductor
NJ-BNCP-PA-CF	Ag	Ag

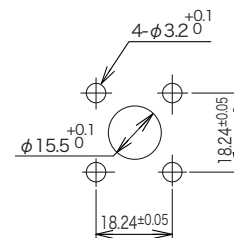
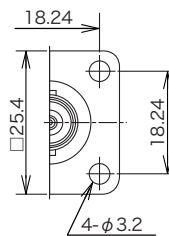
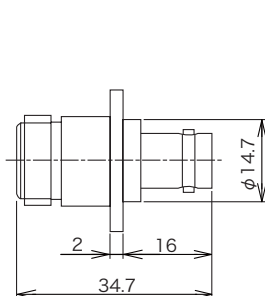

Panel Mounting Dimensions

Part Number	Finish	
	Outer Conductor	Center Conductor
NJ-BNCJ-PA-CF	Ag	Ag

© Specifications and/or dimensions in this catalog are subject to change without notice.
Your checking the latest specifications with our drawings would be highly appreciated.

▶ N to BNC

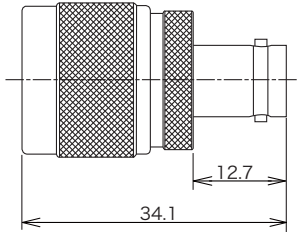

Part Number	Finish	
	Outer Conductor	Center Conductor
NP-BNCJ-CF	Ag	Ag

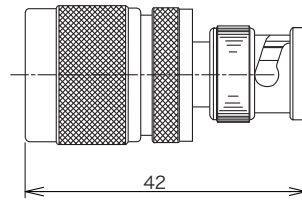

Part Number	Finish	
	Outer Conductor	Center Conductor
NP-BNCP-CF	Ag	Ag

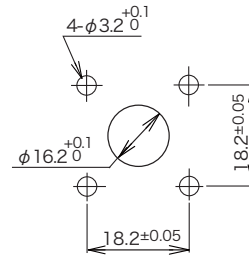
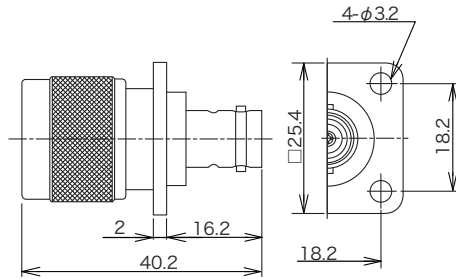

Panel Mounting Dimensions

Part Number	Finish	
	Outer Conductor	Center Conductor
NP-BNCJ-CF	Ag	Ag

▶ N to TNC

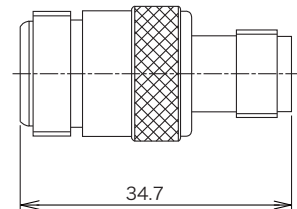

Part Number	Finish	
	Outer Conductor	Center Conductor
NJ-TNCJ-CF	Ag	Ag

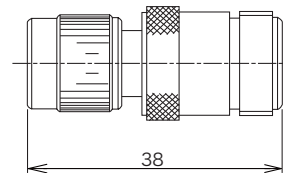

Part Number	Finish	
	Outer Conductor	Center Conductor
NJ-TNCP-CF	Ag	Ag

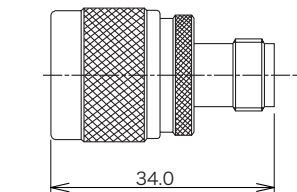

Part Number	Finish	
	Outer Conductor	Center Conductor
NP-TNCJ-CF	Ag	Ag

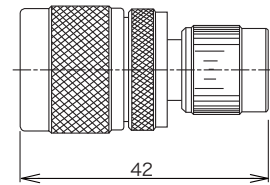

Part Number	Finish	
	Outer Conductor	Center Conductor
NP-TNCP-CF	Ag	Ag

© Specifications and/or dimensions in this catalog are subject to change without notice.
Your checking the latest specifications with our drawings would be highly appreciated.

▶ N to DM

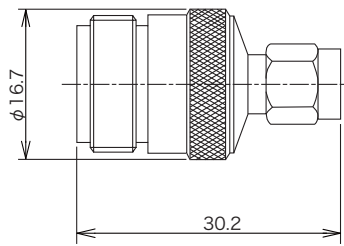

Part Number	Finish	
	Outer Conductor	Center Conductor
NJ-DMP-CF	SUS	Au

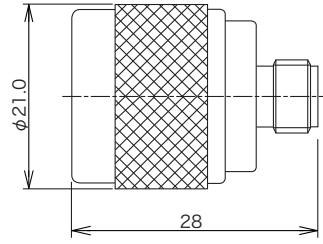

Part Number	Finish	
	Outer Conductor	Center Conductor
NP-DMJ-CF	Au	Au

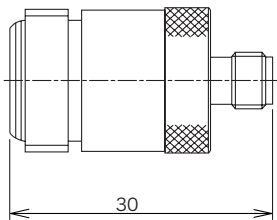

Part Number	Finish	
	Outer Conductor	Center Conductor
NJ-DMJ-CF	Au	Au

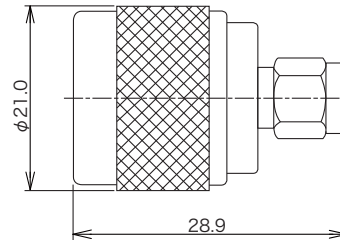

Part Number	Finish	
	Outer Conductor	Center Conductor
NP-DMP-CF	Au	Au

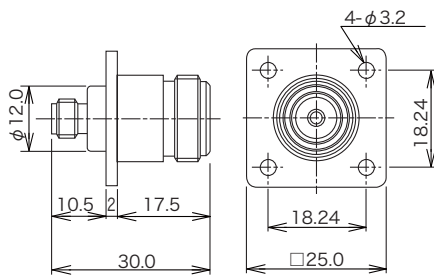

Part Number	Finish	
	Outer Conductor	Center Conductor
NJ-DMJ-PA-1-CF	Ni	Au

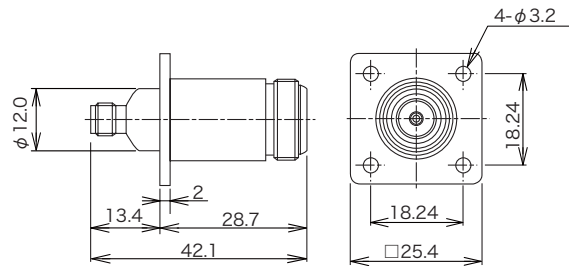

Part Number	Finish	
	Outer Conductor	Center Conductor
NJ-DMJ-PA-2-CF	Ni	Au

© Specifications and/or dimensions in this catalog are subject to change without notice.
Your checking the latest specifications with our drawings would be highly appreciated.

▶ N to SSMB

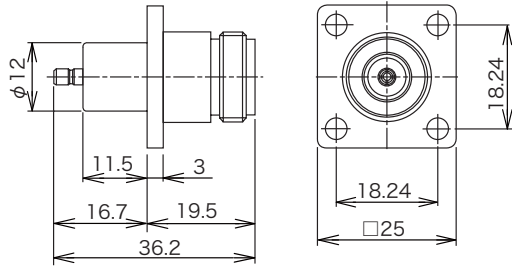

Part Number	Finish	
	Outer Conductor	Center Conductor
NJ-PA-SSMBJ-CF	N : Ni	Au
	SSMB : Au	

▶ N to PDM

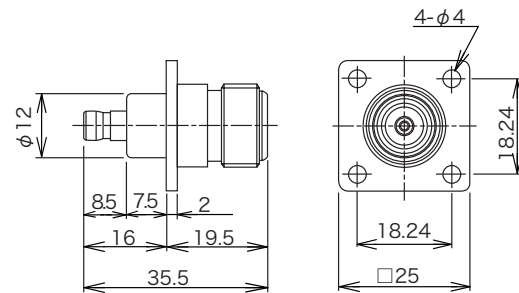
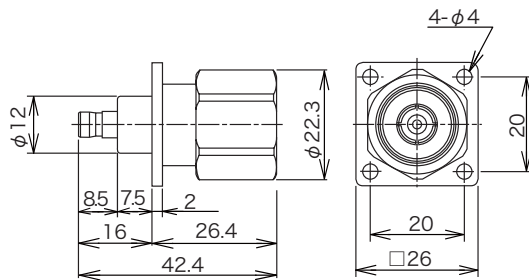

Part Number	Finish	
	Outer Conductor	Center Conductor
NP-PA-PDMJ-CF	Ni	Au

Part Number	Finish	
	Outer Conductor	Center Conductor
NJ-PA-PDMJ-CF	Ni	Au

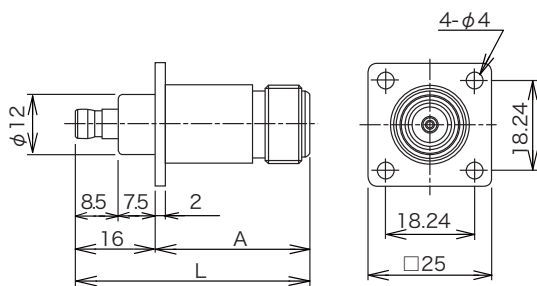

Part Number	A	L	Finish	
			Outer Conductor	Center Conductor
NJ-PA-PDMJ-3-CF	30.6	46.6	Ni	Au
NJ-PA-PDMJ-4-CF	24.6	40.6	Ni	Au
NJ-PA-PDMJ-5-CF	24.0	42.0	Ni	Au

© Specifications and/or dimensions in this catalog are subject to change without notice.
Your checking the latest specifications with our drawings would be highly appreciated.

▶ S to S

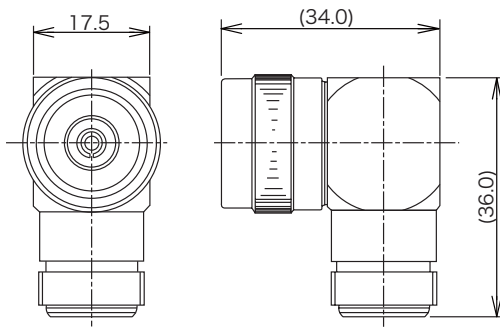

Part Number	Finish	
	Outer Conductor	Center Conductor
S-LA-CF	Ni	Ag

▶ S to DM

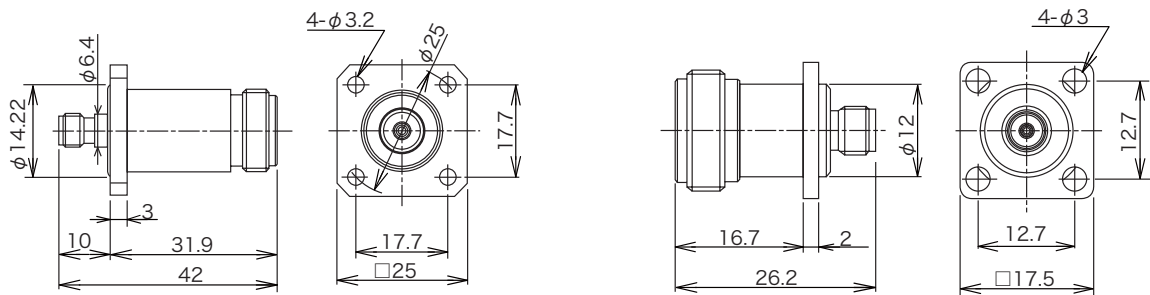

Part Number	Finish		Note
	Outer Conductor	Center Conductor	
SJ-PA-DMJ-CF	Ag	Ag	with Frange, O-ring
SJ-PA-DMJ-D2-CF	Ni	Au	with Frange, O-ring

Part Number	Finish	
	Outer Conductor	Center Conductor
SJ-PA-DMJ-1-CF	Ag	Ag

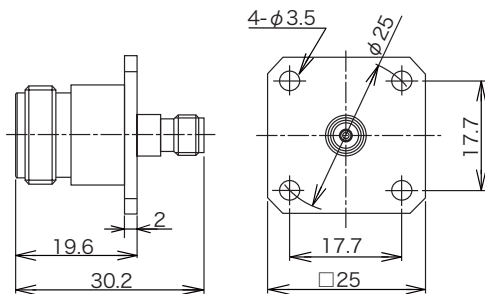

Part Number	Finish	
	Outer Conductor	Center Conductor
SJ-PA-DMJ-2-CF	Ni	Au

▶ S to TNC

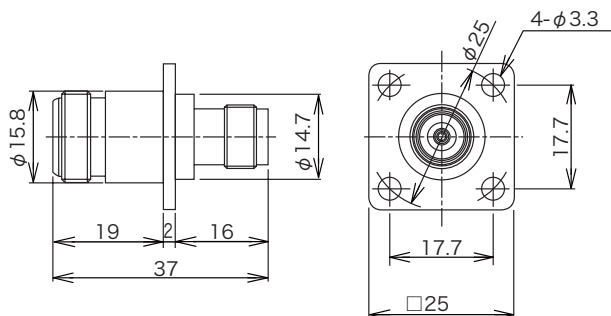

Part Number	Finish	
	Outer Conductor	Center Conductor
SJ-PA-TNCJ-CF	Ni	Au

© Specifications and/or dimensions in this catalog are subject to change without notice.
Your checking the latest specifications with our drawings would be highly appreciated.

▶ BNC to BNC

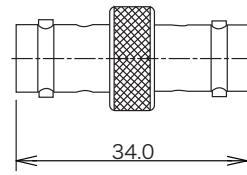
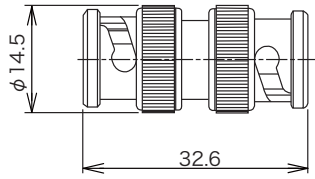

Part Number	Finish	
	Outer Conductor	Center Conductor
BNC-A-PP-CF	Ag	Ag
BNC-A-PP-Ni-CF	Ni	Ag

Part Number	Finish	
	Outer Conductor	Center Conductor
BNC-A-JJ-CF	Ag	Ag
BNC-A-JJ-NiCAu-CF	Ni	Au

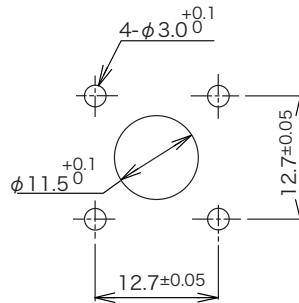
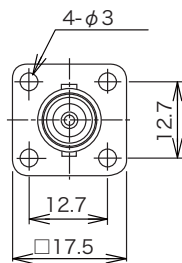
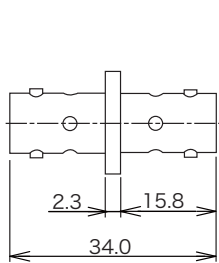

Panel Mounting Dimensions

Part Number	Finish	
	Outer Conductor	Center Conductor
BNC-PA-JJ-CF	Ag	Ag
BNC-PA-JJ-Ni-CF	Ni	Ag
BNC-PA-JJ-NiCAu-CF	Ni	Au

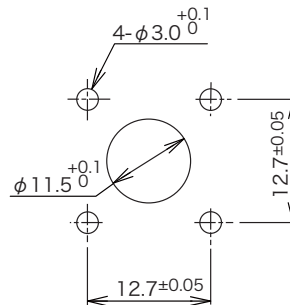
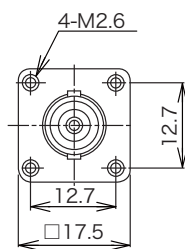
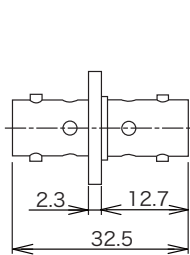

Panel Mounting Dimensions

Part Number	Finish	
	Outer Conductor	Center Conductor
UG-414/U-CF	Ag	Ag

▶ BNC to BNC

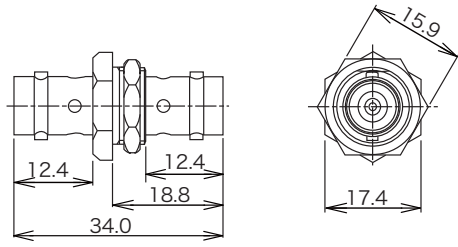

Panel Thickness : 1.5 ~ 3.6

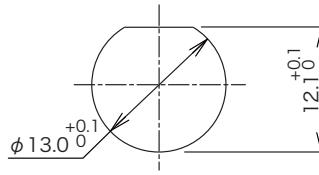

Panel Mounting Dimensions

Part Number	Finish	
	Outer Conductor	Center Conductor
BNC-AB-JJ-CF	Ag	Ag
BNC-AB-JJ-Ni-CF	Ni	Ag

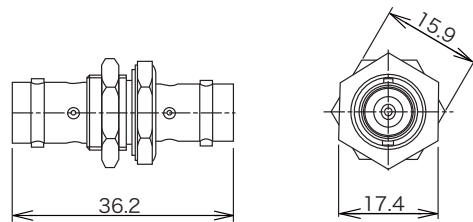

Panel Thickness : 1.5 ~ 5.0

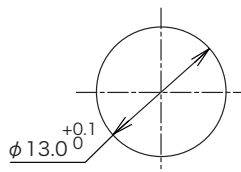

Panel Mounting Dimensions

Part Number	Finish	
	Outer Conductor	Center Conductor
UG-492/U-CF	Ag	Ag

※ Harmetic Seal

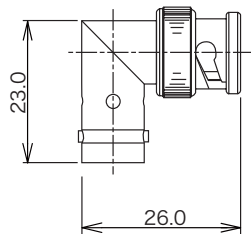

Part Number	Finish	
	Outer Conductor	Center Conductor
BNC-LA-CF	Ag	Ag
BNC-LA-Ni-1-CF	Ni	Ag

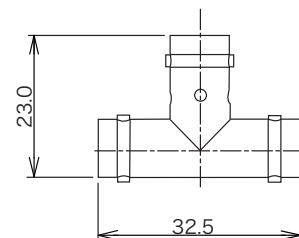
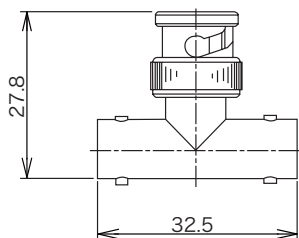

Part Number	Finish	
	Outer Conductor	Center Conductor
BNC-TA-JPJ-CF	Ag	Ag
BNC-TA-JPJ-Ni-CF	Ni	Ag
BNC-TA-JPJ-NiCAu-CF	Ni	Au

Part Number	Finish	
	Outer Conductor	Center Conductor
BNC-TA-JJJ-CF	Ag	Ag
BNC-TA-JJJ-Ni-CF	Ni	Ag

© Specifications and/or dimensions in this catalog are subject to change without notice.
Your checking the latest specifications with our drawings would be highly appreciated.

▶ BNC to TNC

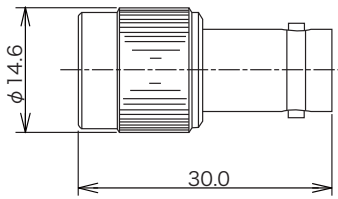

Part Number	Finish	
	Outer Conductor	Center Conductor
BNCJ-TNCP-CF	Ag	Ag

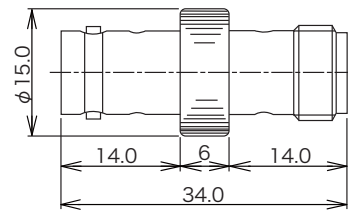

Part Number	Finish	
	Outer Conductor	Center Conductor
BNCJ-TNCJ-CF	Ag	Ag

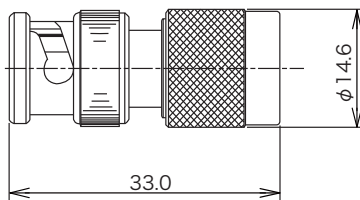

Part Number	Finish	
	Outer Conductor	Center Conductor
BNCP-TNCP-CF	Ag	Ag

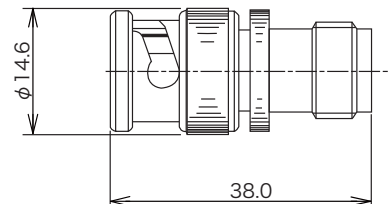

Part Number	Finish	
	Outer Conductor	Center Conductor
BNCP-TNCJ-CF	Ag	Ag

▶ BNC to DM

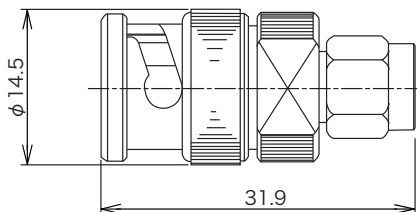

Part Number	Finish	
	Outer Conductor	Center Conductor
BNCP-DMP-CF	Au	Au

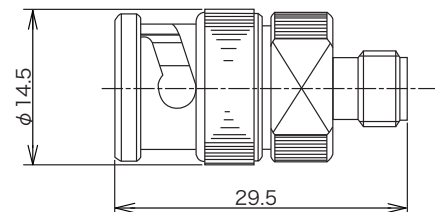

Part Number	Finish	
	Outer Conductor	Center Conductor
BNCP-DMJ-CF	Au	Au

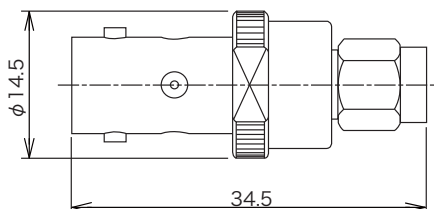

Part Number	Finish	
	Outer Conductor	Center Conductor
BNCJ-DMP-CF	Au	Au

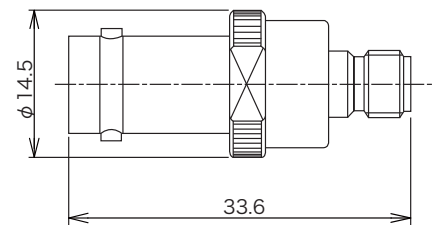

Part Number	Finish	
	Outer Conductor	Center Conductor
BNCJ-DMJ-CF	Au	Au

© Specifications and/or dimensions in this catalog are subject to change without notice.
Your checking the latest specifications with our drawings would be highly appreciated.

▶ TNC to TNC

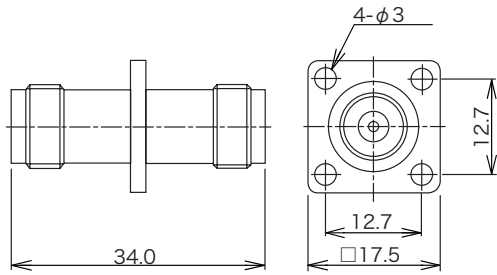

Part Number	Finish	
	Outer Conductor	Center Conductor
TNC-PA-JJ-D1-CF	Ni	Ag

▶ BNC to 27D

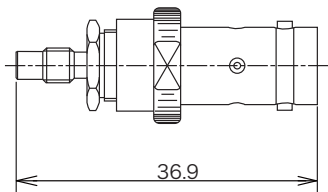

Part Number	Finish	
	Outer Conductor	Center Conductor
BNCJ-27DSJ-CF	Ag	Ag

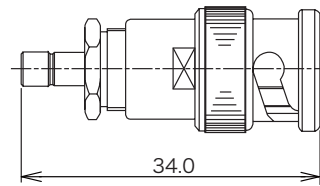

Part Number	Finish	
	Outer Conductor	Center Conductor
BNCP-27DPJ-CF	Ag	Au

▶ TNC to DM

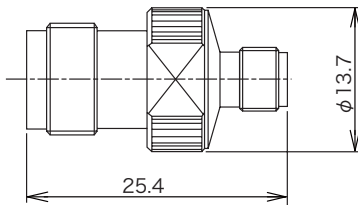

Part Number	Finish	
	Outer Conductor	Center Conductor
TNCJ-DMJ-CF	Au	Au

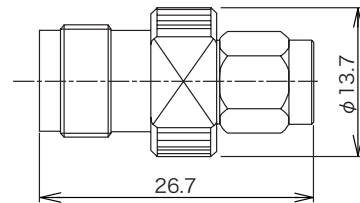

Part Number	Finish	
	Outer Conductor	Center Conductor
DMP-TNCJ-CF	Au	Au

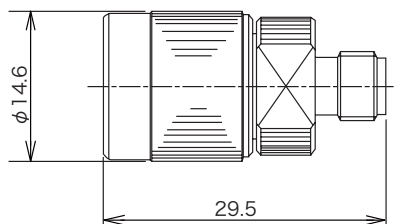

Part Number	Finish	
	Outer Conductor	Center Conductor
TNCP-DMJ-CF	Au	Au

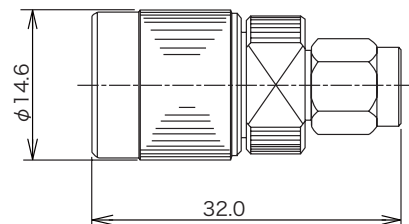

Part Number	Finish	
	Outer Conductor	Center Conductor
TMCP-DMP-CF	Au	Au

© Specifications and/or dimensions in this catalog are subject to change without notice.
Your checking the latest specifications with our drawings would be highly appreciated.

▶ DM to Y90

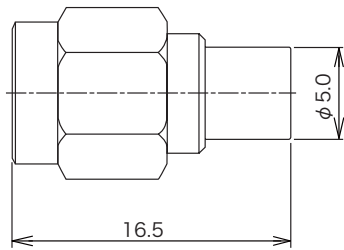

Part Number	Finish	
	Outer Conductor	Center Conductor
DMP-Y90J-CF	Au	Au

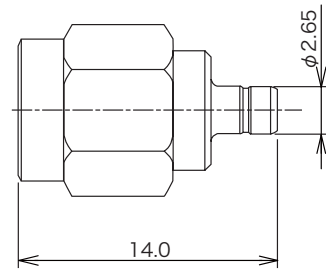

Part Number	Finish	
	Outer Conductor	Center Conductor
DMP-Y90P-CF	Au	Au

▶ DM to LPC

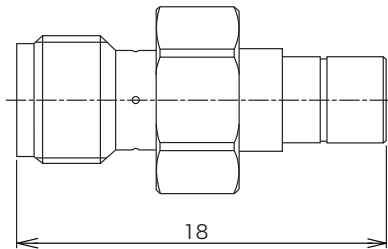

Part Number	Finish	
	Outer Conductor	Center Conductor
DMJ-LPCP	SUS	Au

▶ DM to SSMB

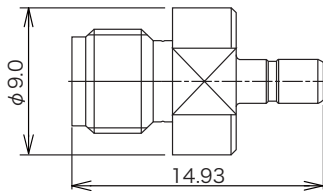

Part Number	Finish	
	Outer Conductor	Center Conductor
DMJ-SSMBJ-CF	Au	Au

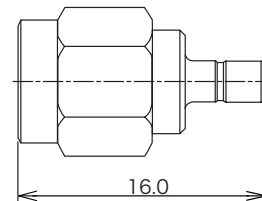

Part Number	Finish	
	Outer Conductor	Center Conductor
DMP-SSMBJ-CF	Au	Au

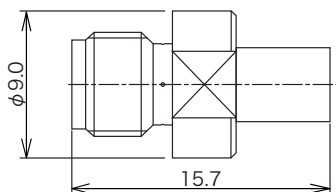

Part Number	Finish	
	Outer Conductor	Center Conductor
DMJ-SSMBP-CF	Au	Au

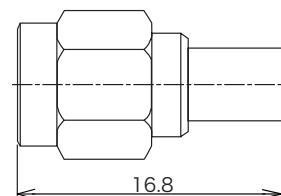

Part Number	Finish	
	Outer Conductor	Center Conductor
DMP-SSMBP-CF	Au	Au

© Specifications and/or dimensions in this catalog are subject to change without notice.
Your checking the latest specifications with our drawings would be highly appreciated.

▶ DM to PDM

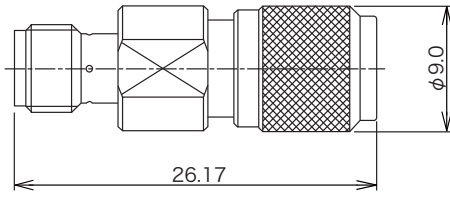

Part Number	Finish	
	Outer Conductor	Center Conductor
DMJ-SA-PDMP-CF	Ni	Au

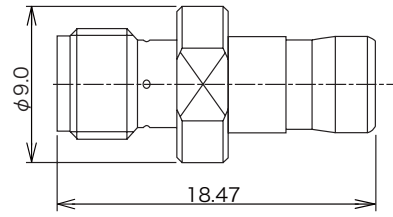

Part Number	Finish	
	Outer Conductor	Center Conductor
DMJ-SA-PDMJ-CF	Ni	Au

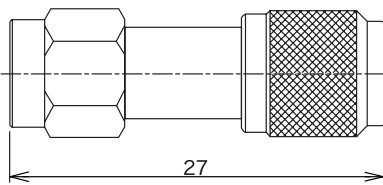

Part Number	Finish	
	Outer Conductor	Center Conductor
DMP-SA-PDMP-CF	Ni	Au

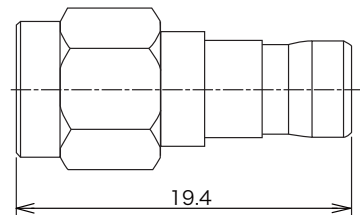

Part Number	Finish	
	Outer Conductor	Center Conductor
DMP-SA-PDMJ-CF	Ni	Au

▶ DM to PMA

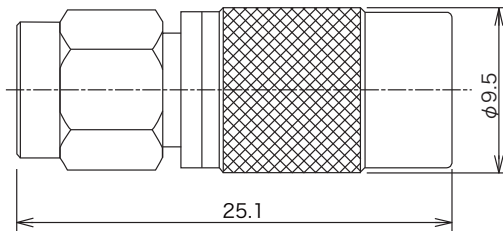

Part Number	Finish	
	Outer Conductor	Center Conductor
DMP-SA-PMAP-CF	Au	Au

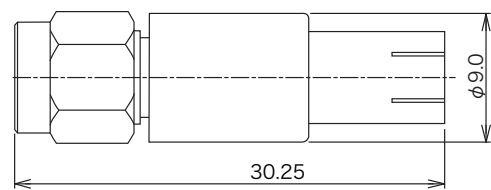

Part Number	Finish	
	Outer Conductor	Center Conductor
DMP-SA-PMAJ-CF	Au	Au

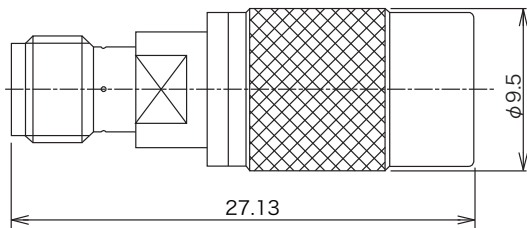

Part Number	Finish	
	Outer Conductor	Center Conductor
DMJ-SA-PMAP-CF	Au	Au

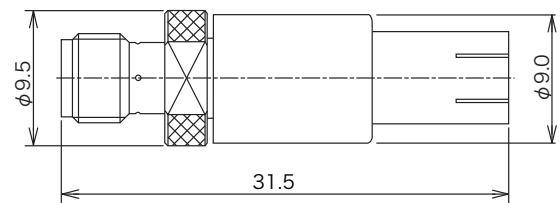

Part Number	Finish	
	Outer Conductor	Center Conductor
DMJ-SA-PMAJ	Au	Au

© Specifications and/or dimensions in this catalog are subject to change without notice.
Your checking the latest specifications with our drawings would be highly appreciated.

▶ DM to PLF

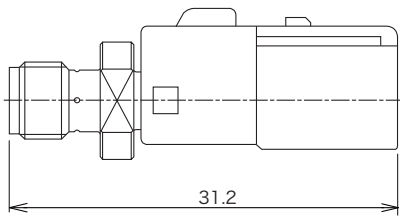

Part Number	Finish	
	Outer Conductor	Center Conductor
DMJ-SA-PLFP-CF	Au	Au

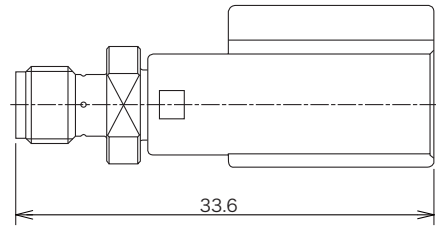

Part Number	Finish	
	Outer Conductor	Center Conductor
DMJ-SA-PLFJ	Au	Au

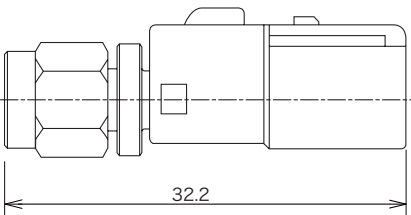

Part Number	Finish	
	Outer Conductor	Center Conductor
DMP-SA-PLFP-CF	Au	Au

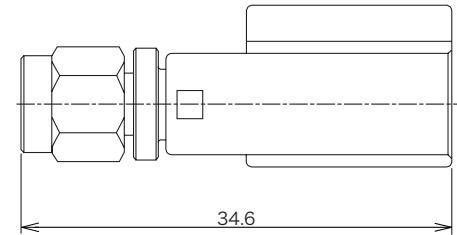

Part Number	Finish	
	Outer Conductor	Center Conductor
DMP-SA-PLFJ-CF	Au	Au

▶ DM to PSD

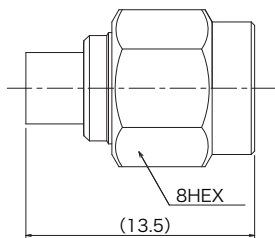

Part Number	Finish	
	Outer Conductor	Center Conductor
DMP-SA-PSDP	Au	Au

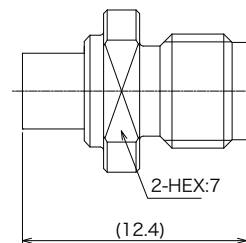

Part Number	Finish	
	Outer Conductor	Center Conductor
DMJ-SA-PSDP	Au	Au

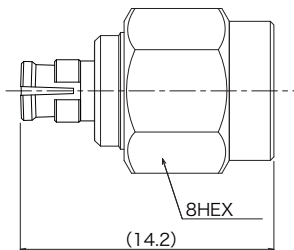

Part Number	Finish	
	Outer Conductor	Center Conductor
DMP-SA-PSDJ	Au	Au

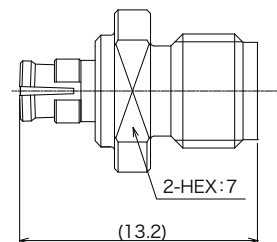

Part Number	Finish	
	Outer Conductor	Center Conductor
DMJ-SA-PSDJ	Au	Au

© Specifications and/or dimensions in this catalog are subject to change without notice.
Your checking the latest specifications with our drawings would be highly appreciated.

▶ DM to DM

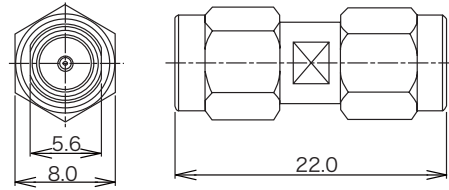
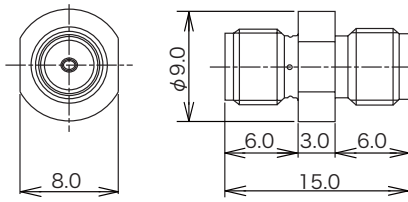

Part Number	Finish	
	Outer Conductor	Center Conductor
DM-A-JJ-CF	Au	Au

Part Number	Finish	
	Outer Conductor	Center Conductor
DM-A-PP-CF	Au	Au

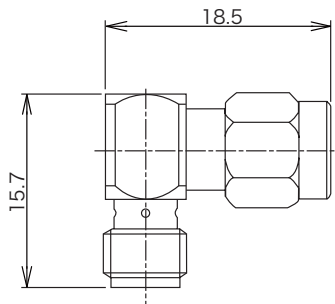

Part Number	Finish	
	Outer Conductor	Center Conductor
DM-LA-CF	Au	Au
DM-LA-JP-CF	Ni	Au

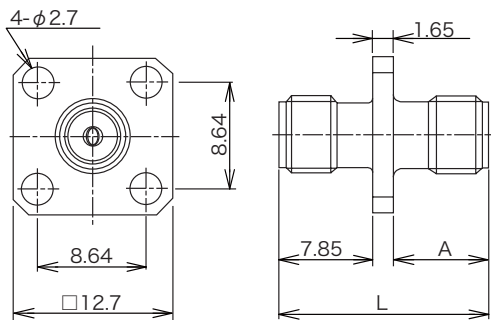

Part Number	A	L	Finish	
			Outer Conductor	Center Conductor
DM-PA-JJ	7.85	17.35	Au	Au
DM-PA-JJ-3-CF	10.9	20.4	Ag	Ag

▶ DM to DM

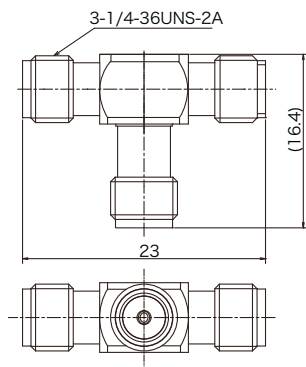

Part Number	Finish	
	Outer Conductor	Center Conductor
DM-TA-JJJ	Au	Au

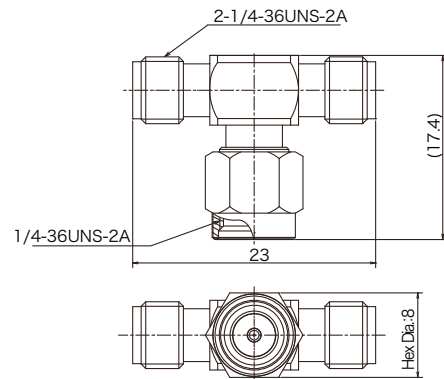

Part Number	Finish	
	Outer Conductor	Center Conductor
DM-TA-JPJ	Au	Au

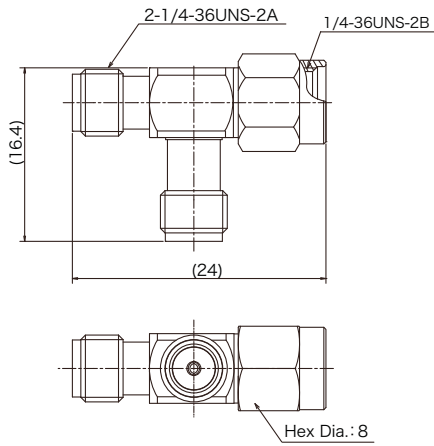

Part Number	Finish	
	Outer Conductor	Center Conductor
DM-TA-PJJ	Au	Au

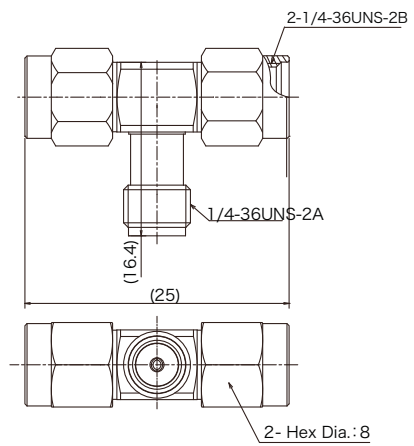

Part Number	Finish	
	Outer Conductor	Center Conductor
DM-TA-PJP	Au	Au

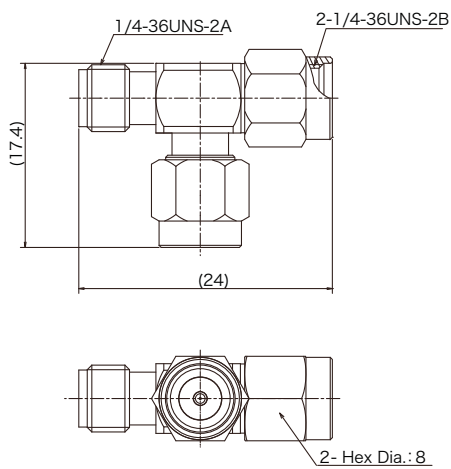

Part Number	Finish	
	Outer Conductor	Center Conductor
DM-TA-PPJ	Au	Au

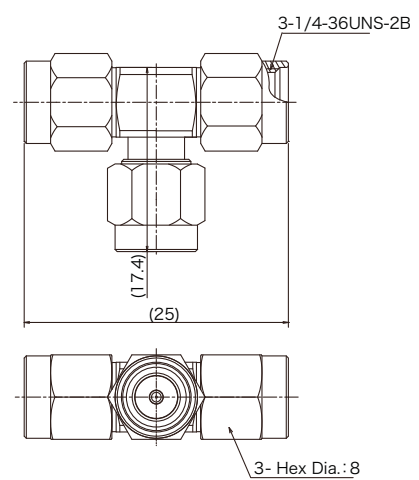

Part Number	Finish	
	Outer Conductor	Center Conductor
DM-TA-PPP	Au	Au

© Specifications and/or dimensions in this catalog are subject to change without notice.
Your checking the latest specifications with our drawings would be highly appreciated.