

## Micropower Voltage Detector

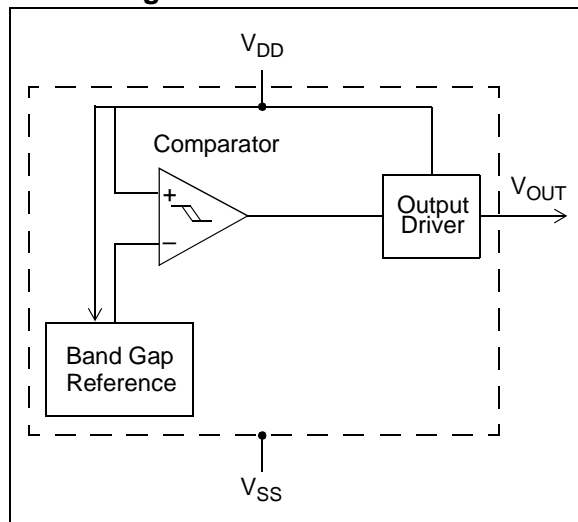
### Features

- Ultra-low supply current: 1.75  $\mu\text{A}$  (max.)
- Precision monitoring options of:
  - 1.90V, 2.32V, 2.63V, 2.90V, 2.93V, 3.08V, 4.38V and 4.63V
- Resets microcontroller in a power-loss event
- Active-low  $V_{\text{OUT}}$  pin:
  - **MCP111** active-low, open-drain
  - **MCP112** active-low, push-pull
- Available in SOT23-3, TO-92 and SC70 packages
- Temperature Range:
  - Extended:  $-40^{\circ}\text{C}$  to  $+125^{\circ}\text{C}$   
(except MCP1XX-195)
  - Industrial:  $-40^{\circ}\text{C}$  to  $+85^{\circ}\text{C}$  (**MCP1XX-195 only**)

### Applications

- Critical  $\mu\text{C}$  and  $\mu\text{P}$  Power-monitoring Applications
- Computers
- Intelligent Instruments
- Portable Battery-Powered Equipment

### Block Diagram



### Description

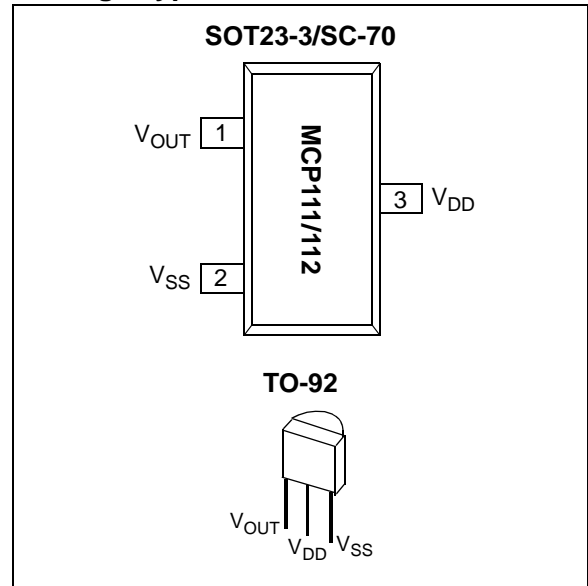
The MCP111/112 are voltage-detecting devices designed to keep a microcontroller in reset until the system voltage has reached, and stabilized, at the appropriate level for reliable system operation. These devices also operate as protection from brown-out conditions when the system supply voltage drops below a safe operating level. The MCP111 and MCP112 are available in eight different trip voltages.

The MCP111 has an open-drain output with an active-low pin ( $V_{\text{OUT}}$ ). This device will assert  $V_{\text{OUT}}$  when the voltage on the  $V_{\text{DD}}$  pin is below the trip-point voltage.

The MCP112 has a push-pull output and will assert an active-low signal ( $V_{\text{OUT}}$  pin) when the voltage on the  $V_{\text{DD}}$  pin is below the trip-point voltage.

During operation, the output ( $V_{\text{OUT}}$ ) remains at a logic-high as long as  $V_{\text{DD}}$  is greater than the specified threshold voltage. When  $V_{\text{DD}}$  falls below the voltage trip point,  $V_{\text{OUT}}$  is driven low.

### Package Types



# MCP111/112

## 1.0 ELECTRICAL CHARACTERISTICS

### Absolute Maximum Ratings†

$V_{DD}$ .....	7.0V
Input current ( $V_{DD}$ ) .....	10 mA
Output current ( $\overline{RST}$ ) .....	10 mA
Rated Rise Time of $V_{DD}$ .....	100V/ $\mu$ s
All inputs and outputs w.r.t. $V_{SS}$ .....	-0.6V to ( $V_{DD} + 1.0V$ )
Storage temperature .....	-65°C to +150°C
Ambient temp. with power applied .....	-40°C to +125°C
Maximum Junction temp. with power applied .....	150°C
ESD protection on all pins .....	$\geq 2$ kV

† **Notice:** Stresses above those listed under “Maximum Ratings” may cause permanent damage to the device. This is a stress rating only and functional operation of the device at those or any other conditions above those indicated in the operational listings of this specification is not implied. Exposure to maximum rating conditions for extended periods may affect device reliability.

### DC CHARACTERISTICS

<b>Electrical Specifications:</b> Unless otherwise indicated, all limits are specified for $V_{DD} = 1V$ to 5.5V, $R_{PU} = 100$ k $\Omega$ (only <b>MCP111</b> ), $T_A = -40^\circ\text{C}$ to $+125^\circ\text{C}$ .							
Parameters	Sym	Min	Typ	Max	Units	Conditions	
Operating Voltage Range	$V_{DD}$	1.0	—	5.5	V		
Specified $V_{DD}$ Value to $V_{OUT}$ low	$V_{DD}$	1.0	—		V	$I_{\overline{RST}} = 10 \mu\text{A}$ , $V_{\overline{RST}} < 0.2\text{V}$	
Operating Current	$I_{DD}$	—	< 1	1.75	$\mu\text{A}$		
$V_{DD}$ Trip Point	<b>MCP1XX-195</b> <b>MCP1XX-240</b> <b>MCP1XX-270</b> <b>MCP1XX-290</b> <b>MCP1XX-300</b> <b>MCP1XX-315</b> <b>MCP1XX-450</b> <b>MCP1XX-475</b>	$V_{TRIP}$	1.872	1.900	1.929	V	$T_A = +25^\circ\text{C}$ ( <b>Note 1</b> )
			1.853	1.900	1.948	V	$T_A = -40^\circ\text{C}$ to $+85^\circ\text{C}$ ( <b>Note 2</b> )
			2.285	2.320	2.355	V	$T_A = +25^\circ\text{C}$ ( <b>Note 1</b> )
			2.262	2.320	2.378	V	<b>Note 2</b>
			2.591	2.630	2.670	V	$T_A = +25^\circ\text{C}$ ( <b>Note 1</b> )
			2.564	2.630	2.696	V	<b>Note 2</b>
			2.857	2.900	2.944	V	$T_A = +25^\circ\text{C}$ ( <b>Note 1</b> )
			2.828	2.900	2.973	V	<b>Note 2</b>
			2.886	2.930	2.974	V	$T_A = +25^\circ\text{C}$ ( <b>Note 1</b> )
			2.857	2.930	3.003	V	<b>Note 2</b>
			3.034	3.080	3.126	V	$T_A = +25^\circ\text{C}$ ( <b>Note 1</b> )
			3.003	3.080	3.157	V	<b>Note 2</b>
$V_{DD}$ Trip Point Tempco	$T_{TPCO}$	—	$\pm 100$	—	ppm/ $^\circ\text{C}$		
Threshold Hysteresis (min. = 1%, max = 6%)	<b>MCP1XX-195</b> <b>MCP1XX-240</b> <b>MCP1XX-270</b> <b>MCP1XX-290</b> <b>MCP1XX-300</b> <b>MCP1XX-315</b> <b>MCP1XX-450</b> <b>MCP1XX-475</b>	$V_{HYS}$	0.019	—	0.114	V	$T_A = +25^\circ\text{C}$
			0.023	—	0.139	V	
			0.026	—	0.158	V	
			0.029	—	0.174	V	
			0.029	—	0.176	V	
			0.031	—	0.185	V	
			0.044	—	0.263	V	
			0.046	—	0.278	V	

**Note 1:** Trip point is  $\pm 1.5\%$  from typical value.

**Note 2:** Trip point is  $\pm 2.5\%$  from typical value.

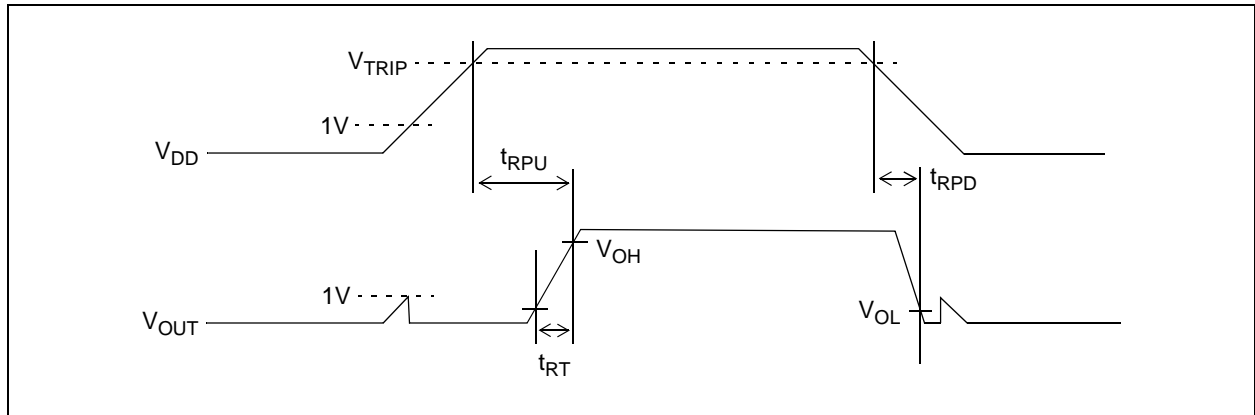
## DC CHARACTERISTICS (CONTINUED)

**Electrical Specifications:** Unless otherwise indicated, all limits are specified for  $V_{DD} = 1V$  to  $5.5V$ ,  $R_{PU} = 100\text{ k}\Omega$  (only **MCP111**),  $T_A = -40^\circ\text{C}$  to  $+125^\circ\text{C}$ .

Parameters	Sym	Min	Typ	Max	Units	Conditions
$V_{OUT}$ Low-level Output Voltage	$V_{OL}$	—	—	0.4	V	$I_{OL} = 500\text{ }\mu\text{A}$ , $V_{DD} = V_{TRIP(MIN)}$
$V_{OUT}$ High-level Output Voltage	$V_{OH}$	$V_{DD} - 0.6$	—	—	V	$I_{OH} = 1\text{ mA}$ , For only <b>MCP112</b> (push-pull output)
Open-Drain Output Leakage Current ( <b>MCP111</b> only)	$I_{OD}$	—	0.1	—	$\mu\text{A}$	

**Note 1:** Trip point is  $\pm 1.5\%$  from typical value.

**Note 2:** Trip point is  $\pm 2.5\%$  from typical value.



**FIGURE 1-1:** Timing Diagram.

## AC CHARACTERISTICS

**Electrical Specifications:** Unless otherwise indicated, all limits are specified for  $V_{DD} = 1V$  to  $5.5V$ ,  $R_{PU} = 100\text{ k}\Omega$  (only **MCP111**),  $T_A = -40^\circ\text{C}$  to  $+125^\circ\text{C}$ .

Parameters	Sym	Min	Typ	Max	Units	Conditions
$V_{DD}$ Detect to $V_{OUT}$ Inactive	$t_{RPU}$	—	90	—	$\mu\text{s}$	<b>Figure 1-1</b> and $C_L = 50\text{ pF}$ ( <b>Note 1</b> )
$V_{DD}$ Detect to $V_{OUT}$ Active	$t_{RPD}$	—	130	—	$\mu\text{s}$	$V_{DD}$ ramped from $V_{TRIP(MAX)} + 250\text{ mV}$ down to $V_{TRIP(MIN)} - 250\text{ mV}$ , per <b>Figure 1-1</b> , $C_L = 50\text{ pF}$ ( <b>Note 1</b> )
$V_{OUT}$ Rise Time After $V_{OUT}$ Active	$t_{RT}$	—	5	—	$\mu\text{s}$	For $V_{OUT}$ 10% to 90% of final value per <b>Figure 1-1</b> , $C_L = 50\text{ pF}$ ( <b>Note 1</b> )

**Note 1:** These parameters are for design guidance only and are not 100% tested.

# MCP111/112

## TEMPERATURE CHARACTERISTICS

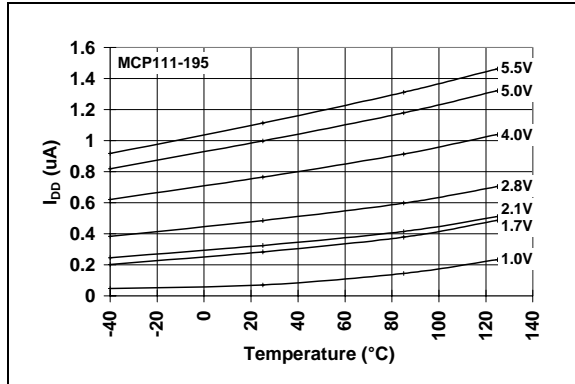
**Electrical Specifications:** Unless otherwise noted, all limits are specified for  $V_{DD} = 1V$  to  $5.5V$ ,  $R_{PU} = 100\text{ k}\Omega$  (only **MCP111**),  $T_A = -40^\circ\text{C}$  to  $+125^\circ\text{C}$ .

Parameters	Sym	Min	Typ	Max	Units	Conditions
<b>Temperature Ranges</b>						
Specified Temperature Range	$T_A$	-40	—	+85	$^\circ\text{C}$	<b>MCP1XX-195</b>
Specified Temperature Range	$T_A$	-40	—	+125	$^\circ\text{C}$	Except <b>MCP1XX-195</b>
Maximum Junction Temperature	$T_J$	—	—	+150	$^\circ\text{C}$	
Storage Temperature Range	$T_A$	-65	—	+150	$^\circ\text{C}$	
<b>Package Thermal Resistances</b>						
Thermal Resistance, 3L-SOT23	$\theta_{JA}$	—	336	—	$^\circ\text{C/W}$	
Thermal Resistance, 3L-SC-70	$\theta_{JA}$	—	340	—	$^\circ\text{C/W}$	
Thermal Resistance, 3L-TO92	$\theta_{JA}$	—	131.9	—	$^\circ\text{C/W}$	

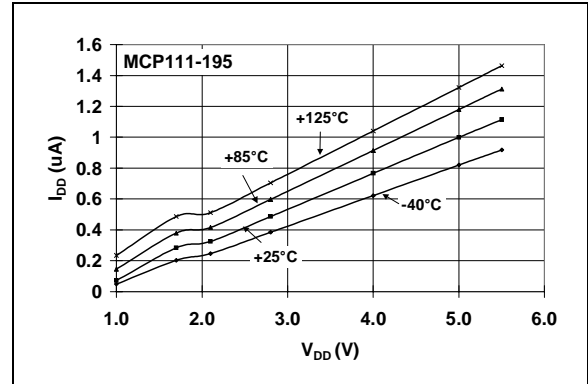
## 2.0 TYPICAL PERFORMANCE CURVES

**Note:** The graphs and tables provided following this note are a statistical summary based on a limited number of samples and are provided for informational purposes only. The performance characteristics listed herein are not tested or guaranteed. In some graphs or tables, the data presented may be outside the specified operating range (e.g., outside specified power supply range) and therefore outside the warranted range.

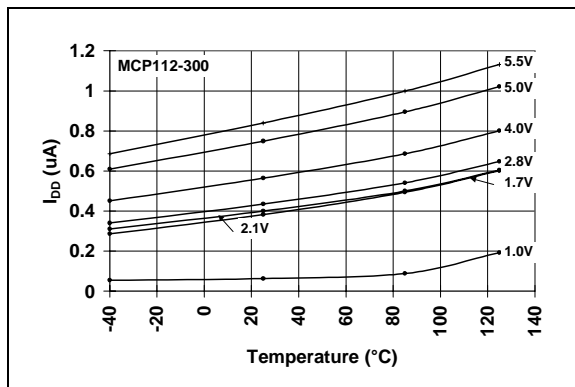
**Note:** Unless otherwise indicated, all limits are specified for  $V_{DD} = 1V$  to  $5.5V$ ,  $R_{PU} = 100\text{ k}\Omega$  (only **MCP111**; see **Figure 4-1**),  $T_A = -40^\circ\text{C}$  to  $+125^\circ\text{C}$ .



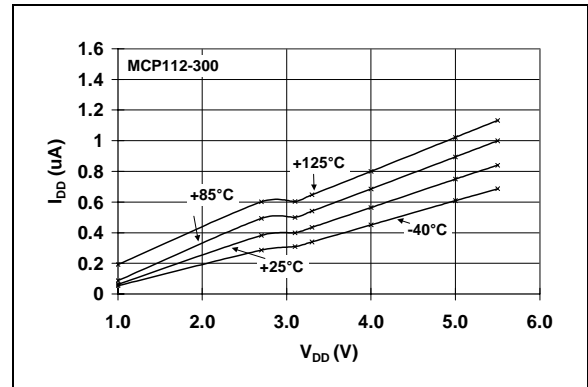
**FIGURE 2-1:**  $I_{DD}$  vs. Temperature (MCP111-195).



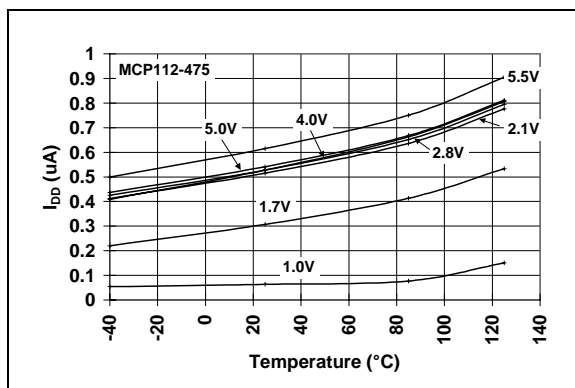
**FIGURE 2-4:**  $I_{DD}$  vs.  $V_{DD}$  (MCP111-195).



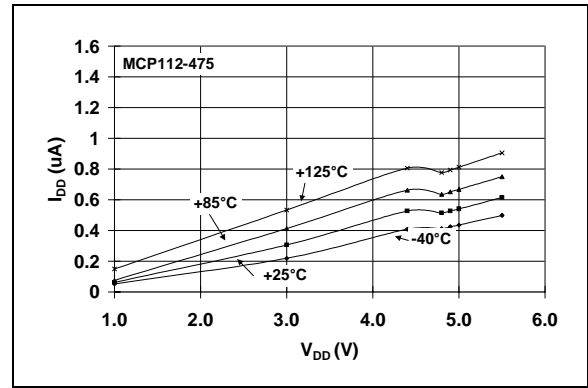
**FIGURE 2-2:**  $I_{DD}$  vs. Temperature (MCP112-300).



**FIGURE 2-5:**  $I_{DD}$  vs.  $V_{DD}$  (MCP112-300).



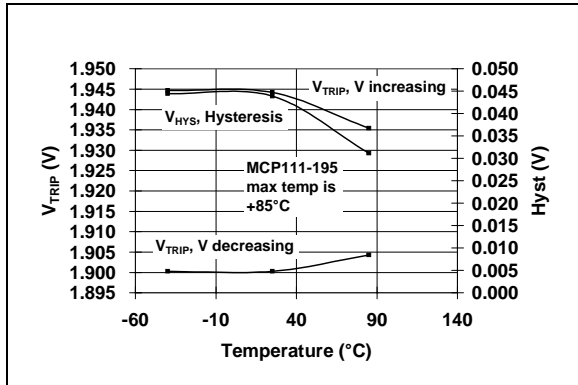
**FIGURE 2-3:**  $I_{DD}$  vs. Temperature (MCP112-475).



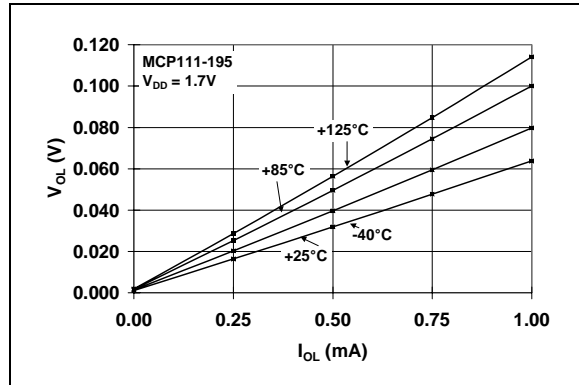
**FIGURE 2-6:**  $I_{DD}$  vs.  $V_{DD}$  (MCP112-475).

# MCP111/112

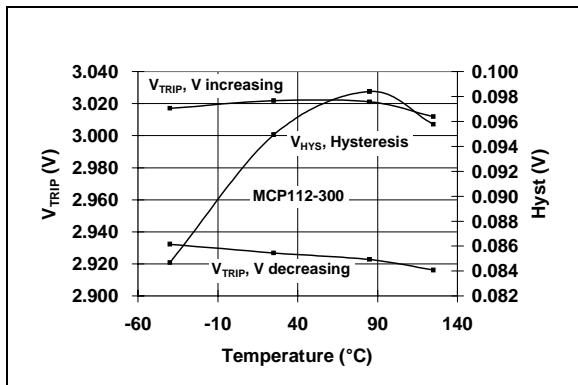
**Note:** Unless otherwise indicated, all limits are specified for  $V_{DD} = 1V$  to  $5.5V$ ,  $R_{PU} = 100\text{ k}\Omega$  (only MCP111; see Figure 4-1),  $T_A = -40^\circ\text{C}$  to  $+125^\circ\text{C}$ .



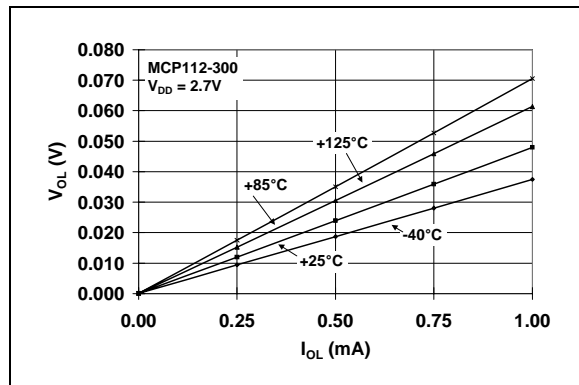
**FIGURE 2-7:**  $V_{TRIP}$  and  $V_{HYST}$  vs. Temperature (MCP111-195).



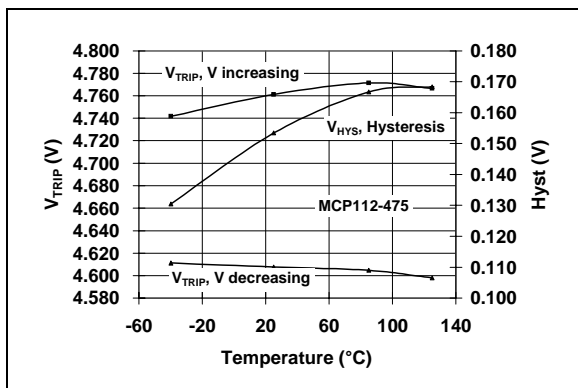
**FIGURE 2-10:**  $V_{OL}$  vs.  $I_{OL}$  (MCP111-195 @  $V_{DD} = 1.7V$ ).



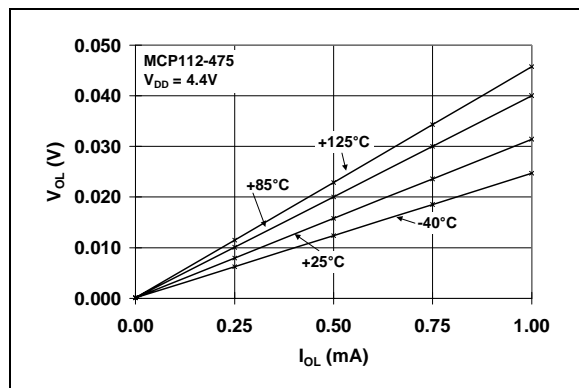
**FIGURE 2-8:**  $V_{TRIP}$  and  $V_{HYST}$  vs. Temperature (MCP112-300).



**FIGURE 2-11:**  $V_{OL}$  vs.  $I_{OL}$  (MCP112-300 @  $V_{DD} = 2.7V$ ).

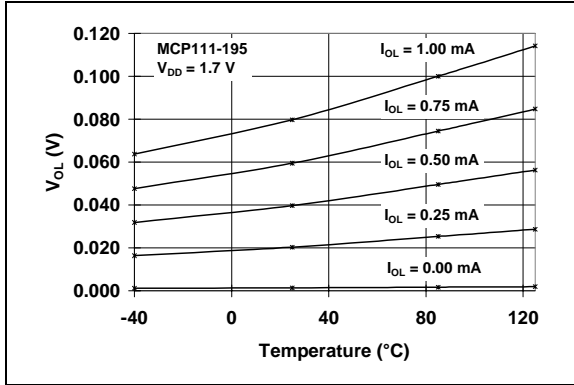


**FIGURE 2-9:**  $V_{TRIP}$  and  $V_{HYST}$  vs. Temperature (MCP112-475).

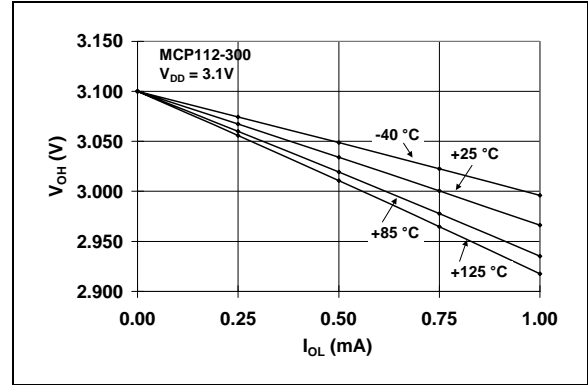


**FIGURE 2-12:**  $V_{OL}$  vs.  $I_{OL}$  (MCP112-475 @  $V_{DD} = 4.4V$ ).

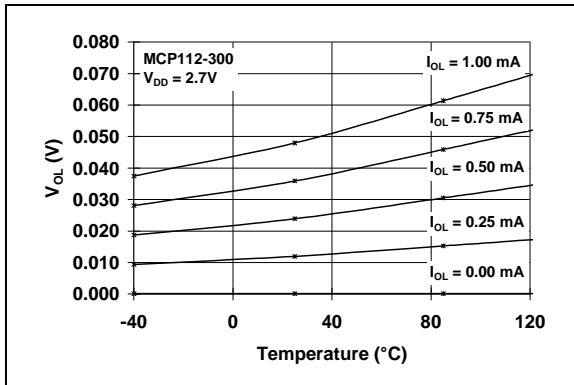
**Note:** Unless otherwise indicated, all limits are specified for  $V_{DD} = 1V$  to  $5.5V$ ,  $R_{PU} = 100\text{ k}\Omega$  (only MCP111; see Figure 4-1),  $T_A = -40^\circ\text{C}$  to  $+125^\circ\text{C}$ .



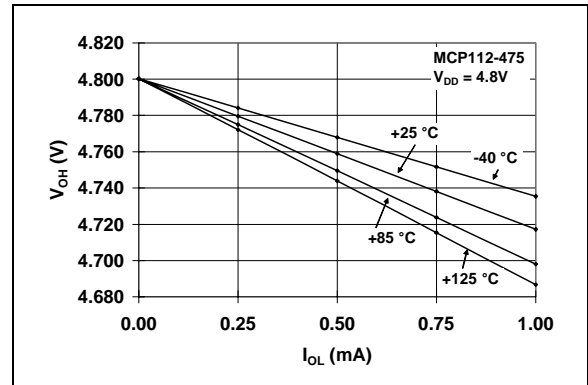
**FIGURE 2-13:**  $V_{OL}$  vs. Temperature (MCP111-195 @  $V_{DD} = 1.7V$ ).



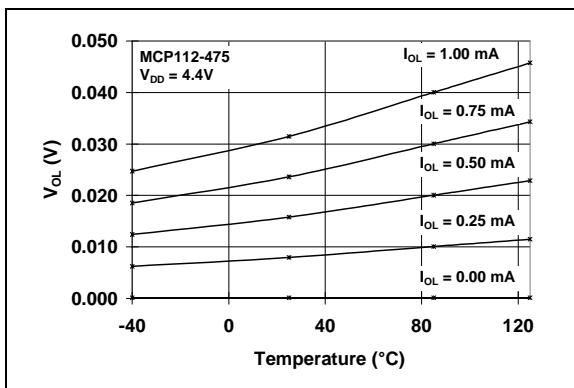
**FIGURE 2-16:**  $V_{OH}$  vs.  $I_{OH}$  (MCP112-300 @  $V_{DD} = 3.1V$ ).



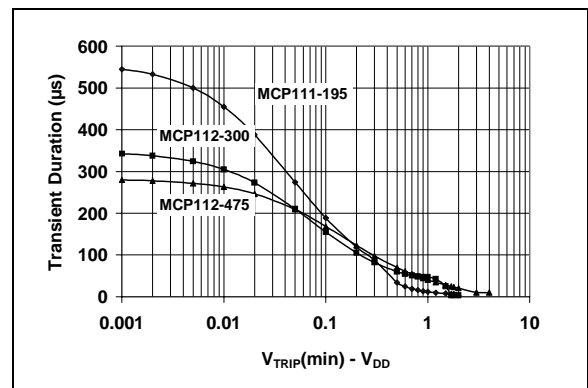
**FIGURE 2-14:**  $V_{OL}$  vs. Temperature (MCP112-300 @  $V_{DD} = 2.7V$ ).



**FIGURE 2-17:**  $V_{OH}$  vs.  $I_{OH}$  (MCP112-475 @  $V_{DD} = 4.8V$ ).



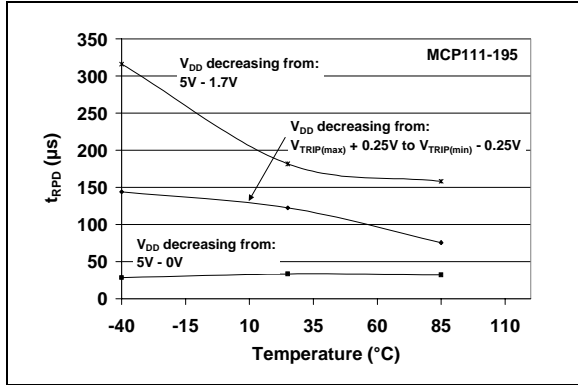
**FIGURE 2-15:**  $V_{OL}$  vs. Temperature (MCP112-475 @  $V_{DD} = 4.4V$ ).



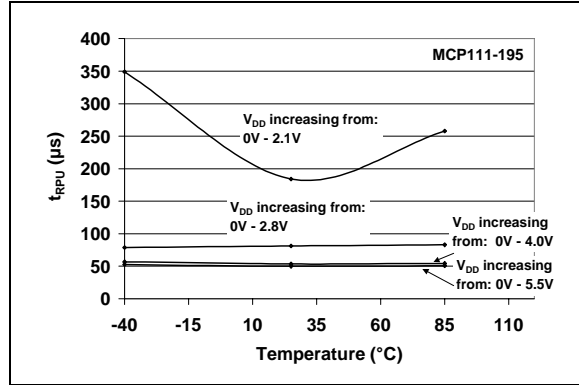
**FIGURE 2-18:** Typical Transient Response ( $25^\circ\text{C}$ ).

# MCP111/112

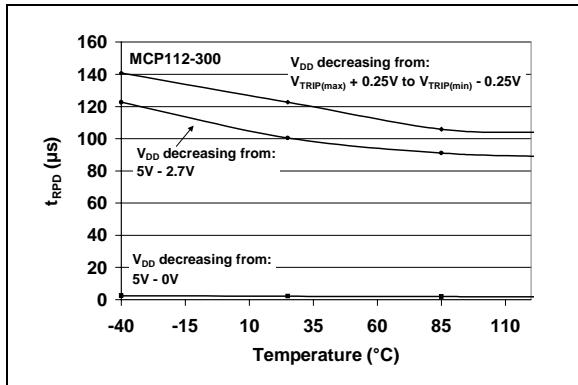
**Note:** Unless otherwise indicated, all limits are specified for  $V_{DD} = 1V$  to  $5.5V$ ,  $R_{PU} = 100\text{ k}\Omega$  (**only MCP111**; see **Figure 4-1**),  $T_A = -40^\circ\text{C}$  to  $+125^\circ\text{C}$ .



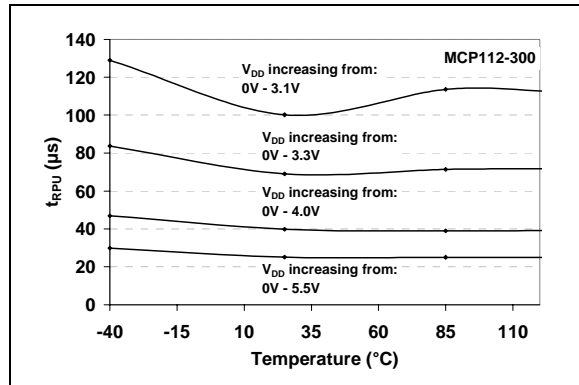
**FIGURE 2-19:**  $t_{RPD}$  vs. Temperature (MCP111-195).



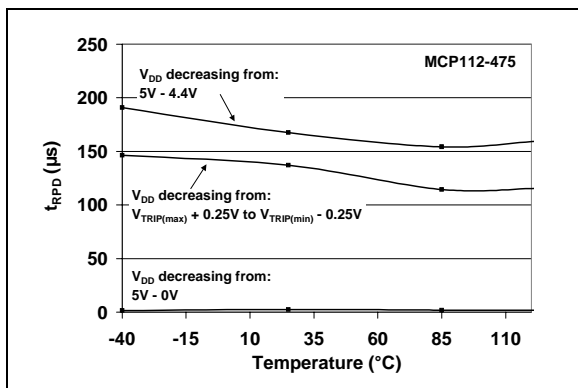
**FIGURE 2-22:**  $t_{RPU}$  vs. Temperature (MCP111-195).



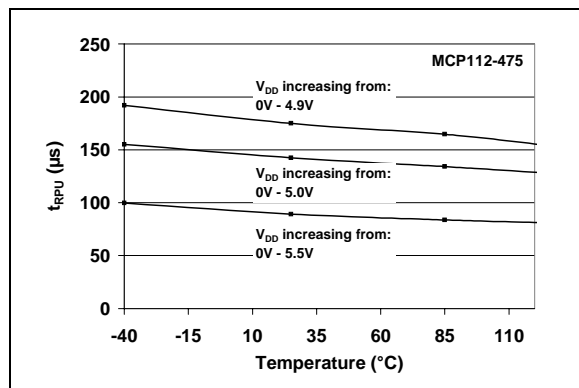
**FIGURE 2-20:**  $t_{RPD}$  vs. Temperature (MCP112-300).



**FIGURE 2-23:**  $t_{RPU}$  vs. Temperature (MCP112-300).



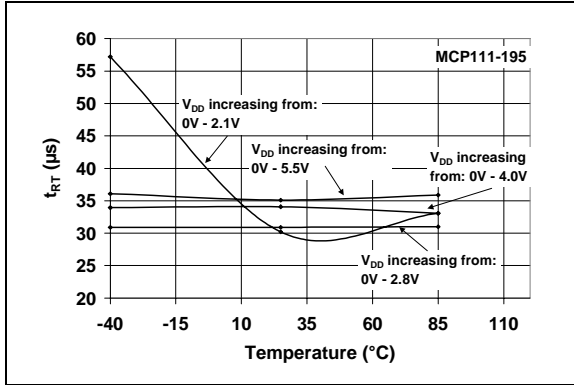
**FIGURE 2-21:**  $t_{RPD}$  vs. Temperature (MCP112-475).



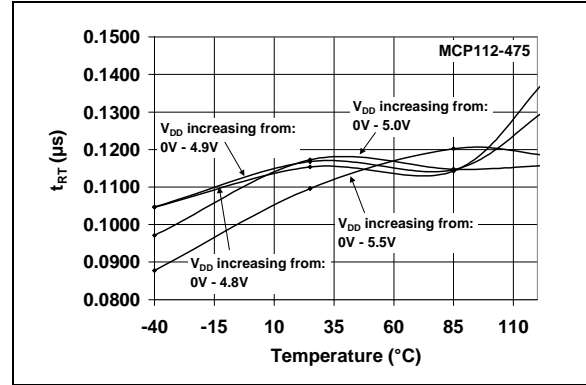
**FIGURE 2-24:**  $t_{RPU}$  vs. Temperature (MCP112-475).



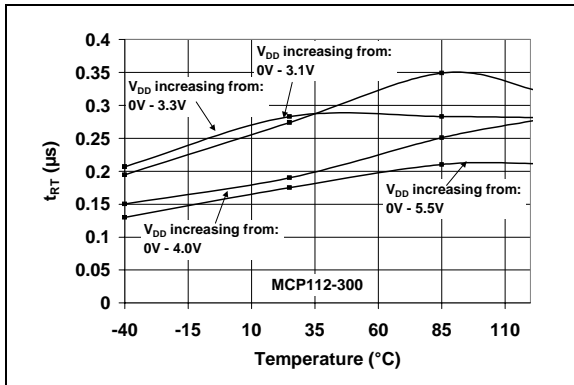
**Note:** Unless otherwise indicated, all limits are specified for  $V_{DD} = 1V$  to  $5.5V$ ,  $R_{PU} = 100\text{ k}\Omega$  (only MCP111; see Figure 4-1),  $T_A = -40^\circ\text{C}$  to  $+125^\circ\text{C}$ .



**FIGURE 2-25:**  $t_{RT}$  vs. Temperature (MCP111-195).



**FIGURE 2-27:**  $t_{RT}$  vs. Temperature (MCP112-475).



**FIGURE 2-26:**  $t_{RT}$  vs. Temperature (MCP112-300).

# MCP111/112

---

## 3.0 PIN DESCRIPTION

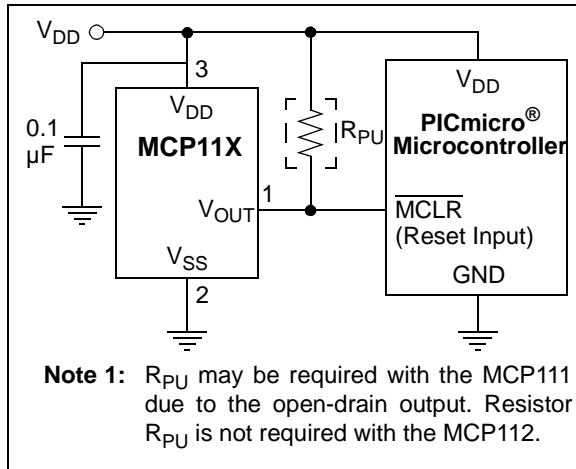
The descriptions of the pins are listed in Table 3-1.

**TABLE 3-1: PIN FUNCTION TABLE**

Pin No.		Symbol	Function
SOT23-3 SC-70	T0-92		
1	1	$V_{OUT}$	<b>Output State</b> <b><math>V_{DD}</math> Falling:</b> $H = V_{DD} > V_{TRIP}$ $L = V_{DD} < V_{TRIP}$  <b><math>V_{DD}</math> Rising:</b> $H = V_{DD} > V_{TRIP} + V_{HYS}$ $L = V_{DD} < V_{TRIP} + V_{HYS}$
2	3	$V_{SS}$	Ground reference
3	2	$V_{DD}$	Positive power supply

## 4.0 APPLICATION INFORMATION

For many of today's microcontroller applications, care must be taken to prevent low-power conditions that can cause many different system problems. The most common causes are brown-out conditions, where the system supply drops below the operating level momentarily. The second most common cause is when a slowly decaying power supply causes the microcontroller to begin executing instructions without sufficient voltage to sustain SRAM, thus producing indeterminate results. Figure 4-1 shows a typical application circuit.

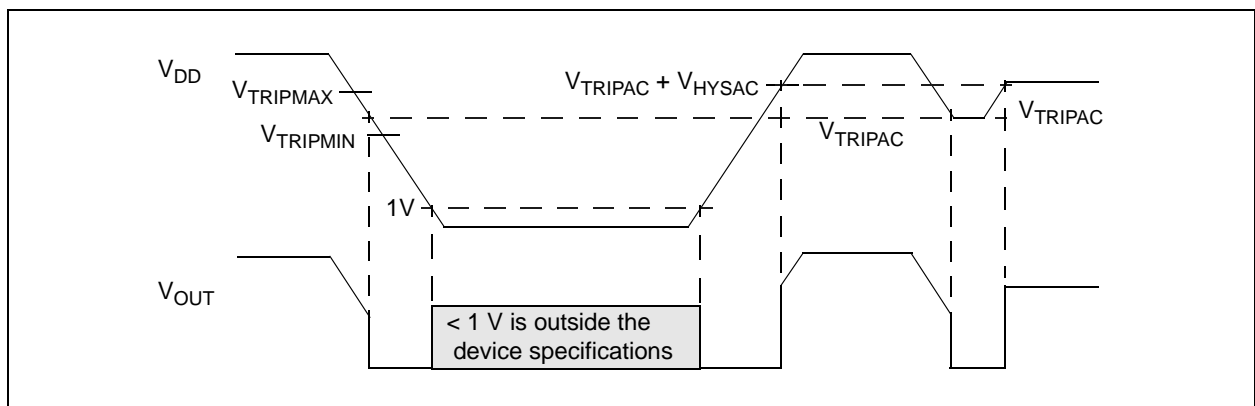


**FIGURE 4-1:** Typical Application Circuit.

## 4.1 $V_{TRIP}$ Operation

The voltage trip point ( $V_{TRIP}$ ) is determined on the falling edge of  $V_{DD}$ . The actual voltage trip point ( $V_{TRIPAC}$ ) will be between the minimum trip point ( $V_{TRIPMIN}$ ) and the maximum trip point ( $V_{TRIPMAX}$ ). There is a hysteresis on this trip point to remove any "jitter" that would occur on the  $V_{OUT}$  pin when the device  $V_{DD}$  is at the trip point.

Figure 4-2 shows the state of the  $V_{OUT}$  pin as determined by the  $V_{DD}$  voltage. The  $V_{TRIP}$  specification is for falling  $V_{DD}$  voltages. When the  $V_{DD}$  voltage is rising, the  $V_{OUT}$  pin will not be driven high until  $V_{DD}$  is at  $V_{TRIP} + V_{HYS}$ .



**FIGURE 4-2:**  $V_{OUT}$  Operation as Determined by the  $V_{TRIP}$  and  $V_{HYS}$ .

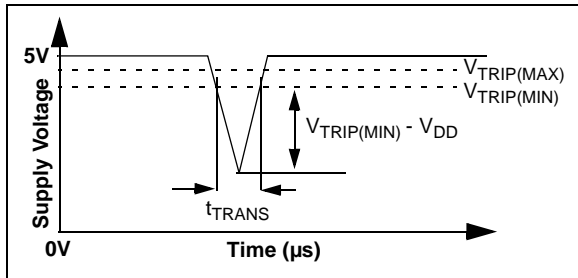
# MCP111/112

## 4.2 Negative Going $V_{DD}$ Transients

The minimum pulse width (time) required to cause a reset may be an important criteria in the implementation of a POR circuit. This time is referred to as transient duration and is the amount of time needed for these supervisory devices to respond to a drop in  $V_{DD}$ . The transient duration time is dependant on the magnitude of  $V_{TRIP} - V_{DD}$ . Generally speaking, the transient duration decreases with increases in  $V_{TRIP} - V_{DD}$ .

Figure 4-3 shows a typical transient duration vs. reset comparator overdrive for which the MCP111/112 will not generate a reset pulse. It shows that the farther below the trip point the transient pulse goes, the duration of the pulse required to cause a reset gets shorter. Figure 2-18 shows the transient response characteristics for the MCP111/112.

A 0.1  $\mu$ F bypass cap mounted as close as possible to the  $V_{DD}$  pin provides additional transient immunity (refer to Figure 4-1).



**FIGURE 4-3:** Example of Typical Transient Duration Waveform.

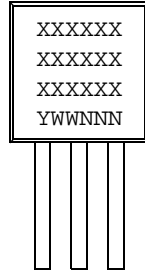
## 4.3 Effect of Temperature on Time-out Period ( $t_{RPU}$ )

The time-out period ( $t_{RPU}$ ) determines how long the device remains in the reset condition. This is affected by both  $V_{DD}$  and temperature. The graph shown in Figures 2-22, 2-23 and 2-24 show the typical response for different  $V_{DD}$  values and temperatures.

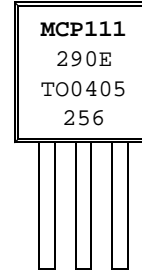
## 5.0 PACKAGING INFORMATION

### 5.1 Package Marking Information

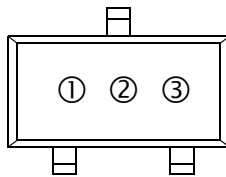
3-Lead TO-92



Example:



3-Pin SC-70

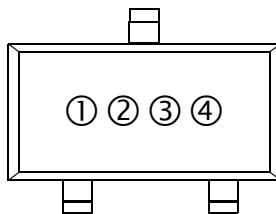


Top Side

Example:

Part Number	SC-70	Part Number	SC-70
MCP111T-195/LB	EPN	MCP112T-195/LB	ERN
MCP111T-240E/LB	EQN	MCP112T-240E/LB	ESN
MCP111T-270E/LB	EGN	MCP112T-270E/LB	EAN
MCP111T-290E/LB	EHN	MCP112T-290E/LB	EBN
MCP111T-300E/LB	EJN	MCP112T-300E/LB	ECN
MCP111T-315E/LB	EKN	MCP112T-315E/LB	EDN
MCP111T-450E/LB	ELN	MCP112T-450E/LB	EEN
MCP111T-475E/LB	EMN	MCP112T-475E/LB	EFN

3-Pin SOT-23B



Example:

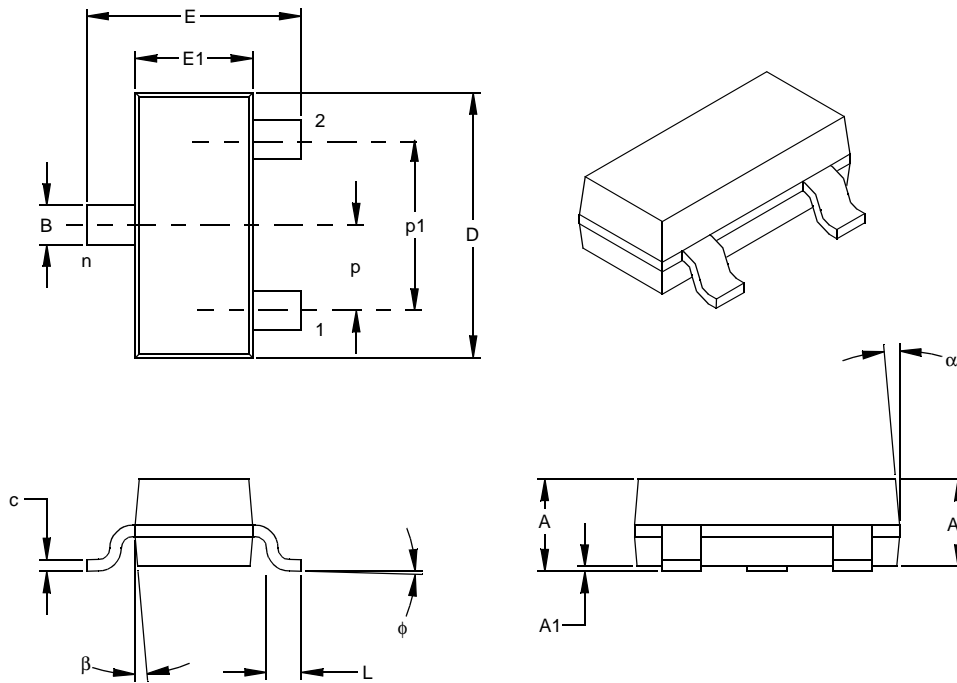
Part Number	SOT-23	Part Number	SOT-23
MCP111T-195/TT	MPNN	MCP112T-195/TT	MRNN
MCP111T-240ETT	MQNN	MCP112T-240ETT	MSNN
MCP111T-270E/TT	MGNN	MCP112T-270E/TT	MANN
MCP111T-290E/TT	NHNN	MCP112T-290E/TT	MBNN
MCP111T-300E/TT	MJNN	MCP112T-300E/TT	MCNN
MCP111T-315E/TT	MKNN	MCP112T-315E/TT	MDNN
MCP111T-450E/TT	MLNN	MCP112T-450E/TT	MENN
MCP111T-475E/TT	MMNN	MCP112T-475E/TT	MFNN

<b>Legend:</b>	1	Part Number + temperature range and voltage (two-digit code)
	2	Part Number + temperature range and voltage (two-digit code)
	3	Lot ID number
	4	Year and work week

**Note:** In the event the full Microchip part number cannot be marked on one line, it will be carried over to the next line thus limiting the number of available characters for customer specific information.

# MCP111/112

## 3-Lead Plastic Small Outline Transistor (TT) (SOT-23)



Units		INCHES*			MILLIMETERS		
Dimension	Limits	MIN	NOM	MAX	MIN	NOM	MAX
Number of Pins	n		3			3	
Pitch	p		.038			0.96	
Outside lead pitch (basic)	p1		.076			1.92	
Overall Height	A	.035	.040	.044	0.89	1.01	1.12
Molded Package Thickness	A2	.035	.037	.040	0.88	0.95	1.02
Standoff §	A1	.000	.002	.004	0.01	0.06	0.10
Overall Width	E	.083	.093	.104	2.10	2.37	2.64
Molded Package Width	E1	.047	.051	.055	1.20	1.30	1.40
Overall Length	D	.110	.115	.120	2.80	2.92	3.04
Foot Length	L	.014	.018	.022	0.35	0.45	0.55
Foot Angle	φ	0	5	10	0	5	10
Lead Thickness	c	.004	.006	.007	0.09	0.14	0.18
Lead Width	B	.015	.017	.020	0.37	0.44	0.51
Mold Draft Angle Top	α	0	5	10	0	5	10
Mold Draft Angle Bottom	β	0	5	10	0	5	10

\* Controlling Parameter  
 § Significant Characteristic

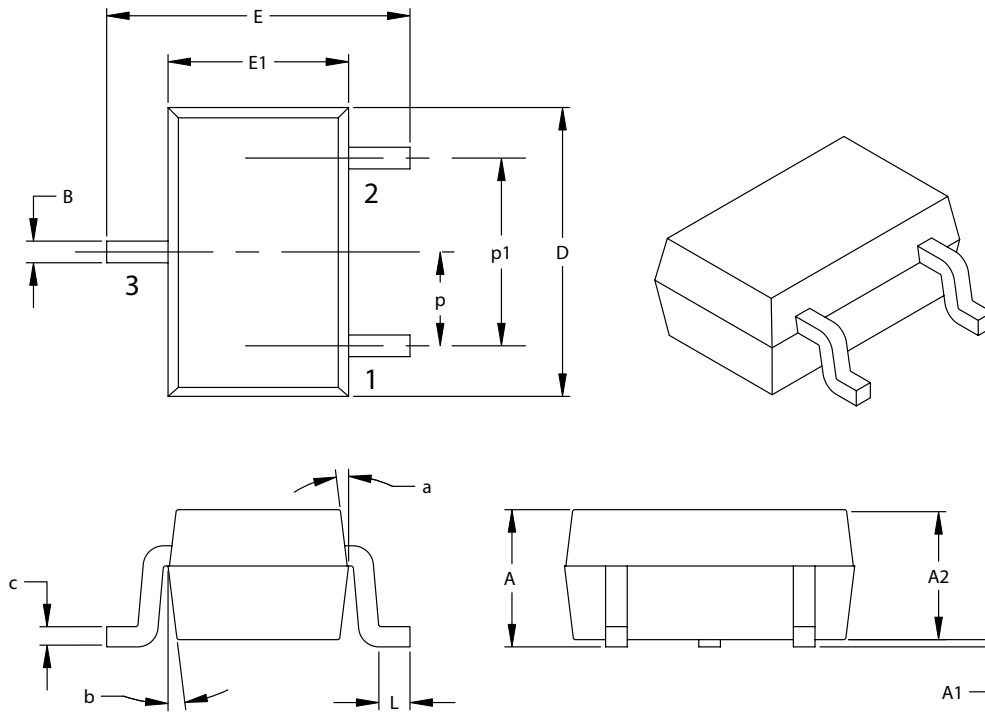
Notes:

Dimensions D and E1 do not include mold flash or protrusions. Mold flash or protrusions shall not exceed .010" (0.254mm) per side.

JEDEC Equivalent: TO-236

Drawing No. C04-104

## 3-Lead Plastic Small Outline Transistor (LB) (SC-70)



Dimension Limits	Units	INCHES		MILLIMETERS*	
		MIN	MAX	MIN	MAX
Number of Pins		3		3	
Pitch	p	.026 BSC.		0.65 BSC.	
Outside lead pitch (basic)	p1	.051 BSC.		1.30 BSC.	
Overall Height	A	.031	.043	0.80	1.10
Molded Package Thickness	A2	.031	.039	0.80	1.00
Standoff	A1	.000	.0004	0.00	.010
Overall Width	E	.071	.094	1.80	2.40
Molded Package Width	E1	.045	.053	1.15	1.35
Overall Length	D	.071	.089	1.80	2.25
Foot Length	L	.004	.016	0.10	0.41
Lead Thickness	c	.003	.010	0.08	0.25
Lead Width	B	.006	.016	0.15	0.40
Mold Draft Angle Top	a	8°	12°	8°	12°
Mold Draft Angle Bottom	b	8°	12°	8°	12°

\*Controlling Parameter

Notes:

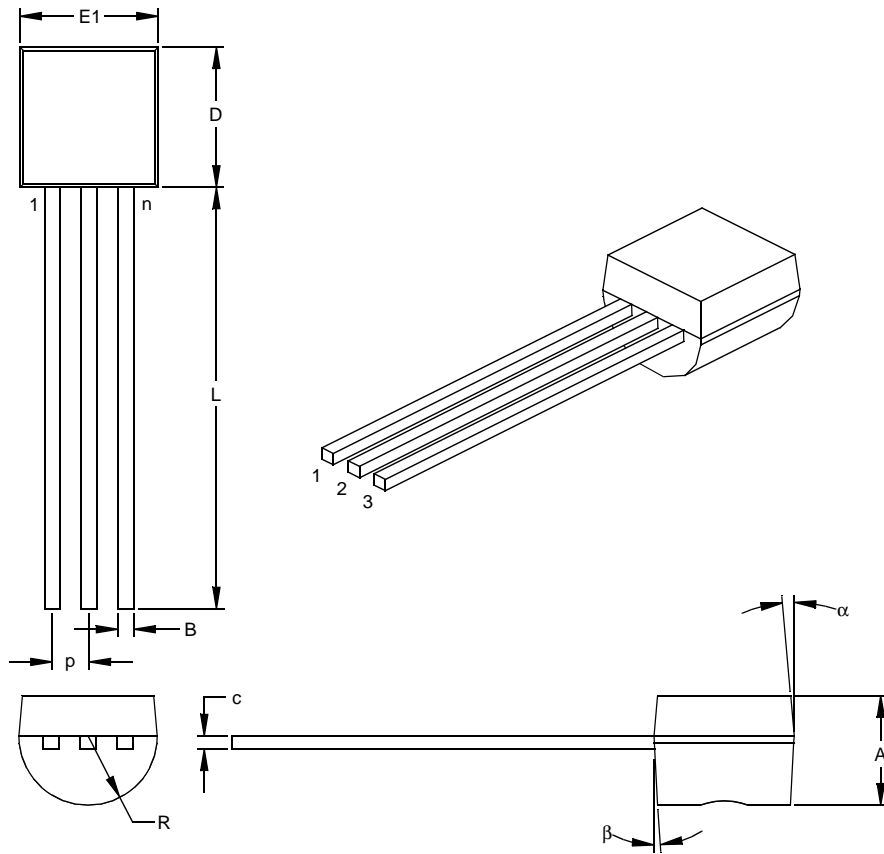
Dimensions D and E1 do not include mold flash or protrusions. Mold flash or protrusions shall not exceed .005" (0.127mm) per side.

JEITA (EIAJ) Equivalent: SC70

Drawing No. C04-104

# MCP111/112

## 3-Lead Plastic Transistor Outline (TO) (TO-92)



Dimension Limits	Units	INCHES*			MILLIMETERS		
		MIN	NOM	MAX	MIN	NOM	MAX
Number of Pins	n		3			3	
Pitch	p		.050			1.27	
Bottom to Package Flat	A	.130	.143	.155	3.30	3.62	3.94
Overall Width	E1	.175	.186	.195	4.45	4.71	4.95
Overall Length	D	.170	.183	.195	4.32	4.64	4.95
Molded Package Radius	R	.085	.090	.095	2.16	2.29	2.41
Tip to Seating Plane	L	.500	.555	.610	12.70	14.10	15.49
Lead Thickness	c	.014	.017	.020	0.36	0.43	0.51
Lead Width	B	.016	.019	.022	0.41	0.48	0.56
Mold Draft Angle Top	$\alpha$	4	5	6	4	5	6
Mold Draft Angle Bottom	$\beta$	2	3	4	2	3	4

\*Controlling Parameter

Notes:

Dimensions D and E1 do not include mold flash or protrusions. Mold flash or protrusions shall not exceed

.010" (0.254mm) per side.

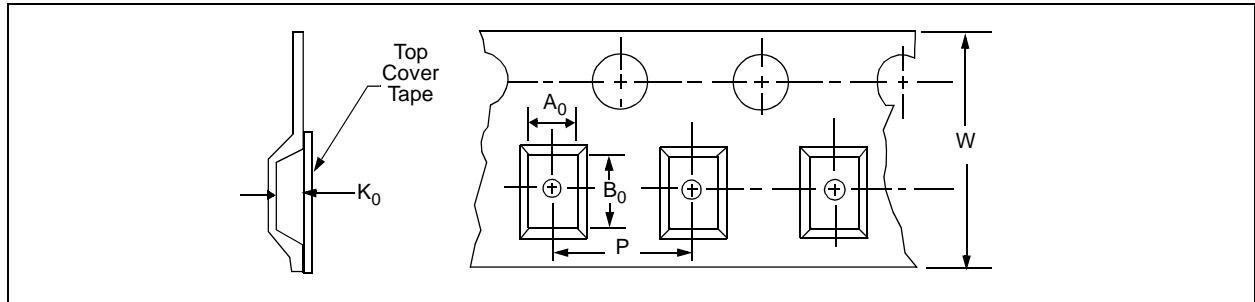
JEDEC Equivalent: TO-92

Drawing No. C04-101



## 5.2 Product Tape and Reel Specifications

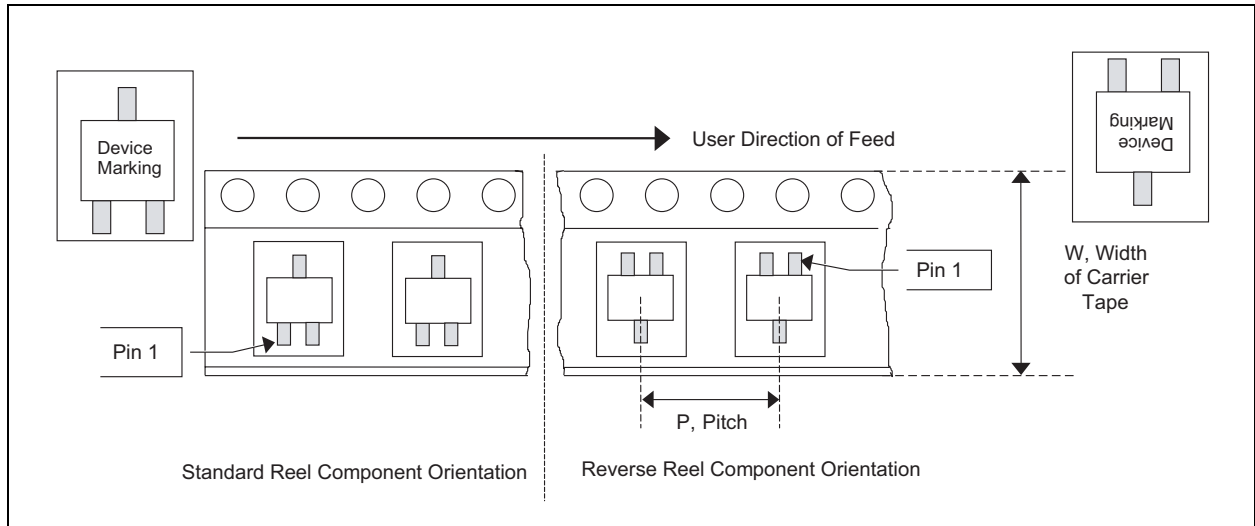
**FIGURE 5-1: EMBOSED CARRIER DIMENSIONS (8, 12, 16 AND 24 MM TAPE ONLY)**



**TABLE 1: CARRIER TAPE/CAVITY DIMENSIONS**

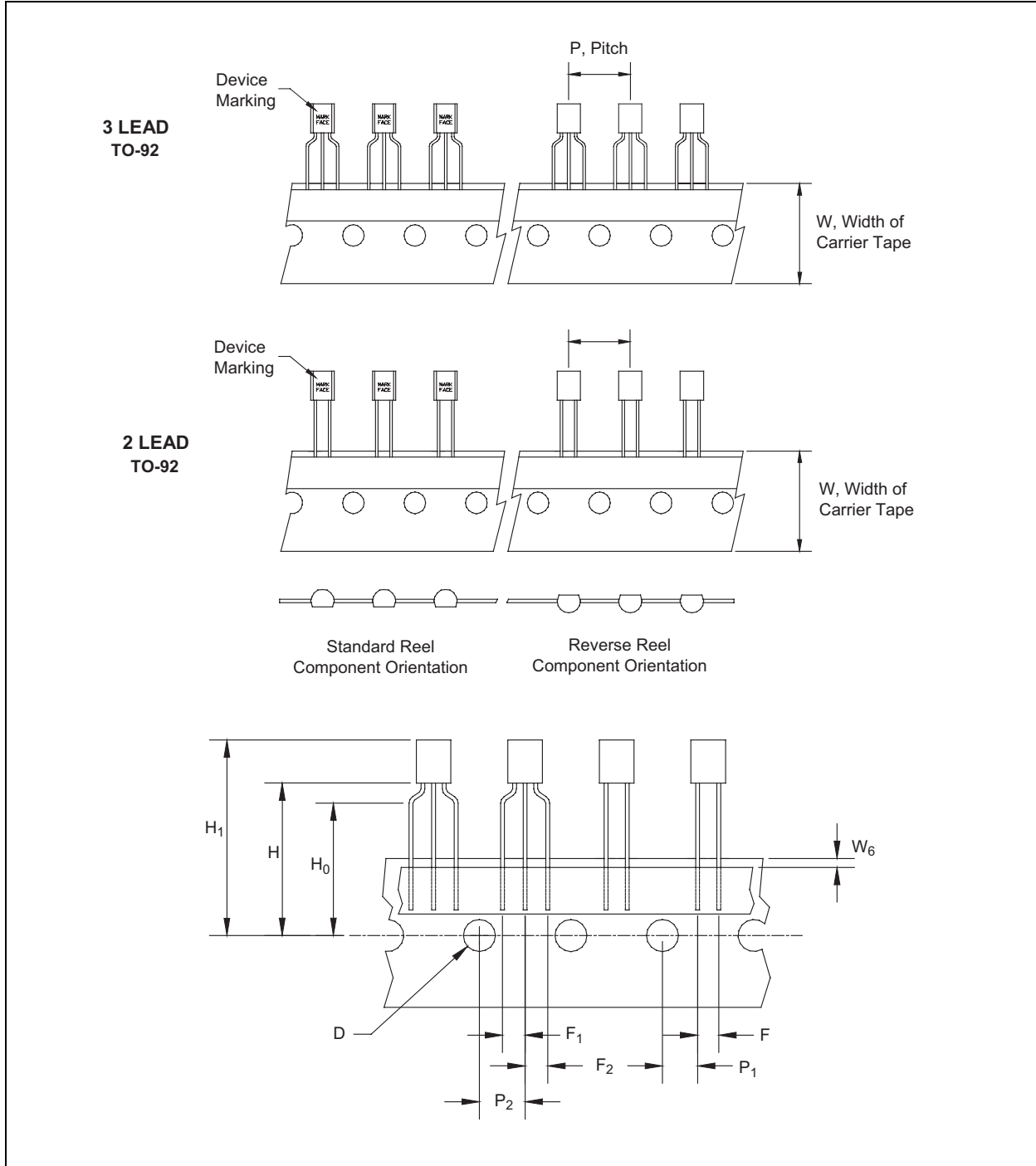
Case Outline	Package Type		Carrier Dimensions		Cavity Dimensions			Output Quantity Units	Reel Diameter in mm
			W mm	P mm	A0 mm	B0 mm	K0 mm		
TT	SOT-23B	3L	8	4	3.15	2.77	1.22	3000	180
LB	SC-70	3L	8	4	2.4	2.4	1.19	3000	180

**FIGURE 5-2: 3-LEAD SOT-23/SC70 DEVICE TAPE AND REEL SPECIFICATIONS**



# MCP111/112

FIGURE 5-3: TO-92 DEVICES



## PRODUCT IDENTIFICATION SYSTEM

To order or obtain information, e.g., on pricing or delivery, refer to the factory or the listed sales office.

<u>PART NO.</u>	<u>X</u>	<u>XXX</u>	<u>X</u>	<u>XX</u>	<b>Examples:</b>
Device	Tape/Reel Option	Monitoring Options	Temperature Range	Package	
<p>Device:</p> <p>MCP111: MicroPower Voltage Detector, open-drain MCP111T: MicroPower Voltage Detector, open-drain (Tape and Reel)</p> <p>MCP112: MicroPower Voltage Detector, push-pull MCP112T: MicroPower Voltage Detector, push-pull (Tape and Reel)</p> <p>Monitoring Options:</p> <p>195 = 1.90V 240 = 2.32V 270 = 2.63V 290 = 2.90V 300 = 2.93V 315 = 3.08V 450 = 4.38V 475 = 4.63V</p> <p>Temperature Range:</p> <p>I = -40°C to +85°C (MCP11X-195 only) E = -40°C to +125°C (Except MCP11X-195 only)</p> <p>Package:</p> <p>TT = SOT-23B, 3-lead LB = SC-70, 3-lead TO = TO-92, 3-lead</p>					<p>a) MCP111T-195I/TT: Tape and Reel, 1.95V option, open-drain, -40°C to +85°C, SOT-23B package.</p> <p>b) MCP111T-315E/LB: Tape and Reel, 3.15V option, open-drain, -40°C to +125°C, SC-70-3 package.</p> <p>c) MCP111-300E/TO: 3.00V option, open-drain, -40°C to +125°C, TO-92-3 package.</p> <p>a) MCP112T-290E/TT: Tape and Reel, 2.90V option, push-pull, - 40°C to +125°C, SOT-23B-3 package.</p> <p>b) MCP112T-475E/LB: Tape and Reel, 4.75V option, push-pull, -40°C to +125°C, SC-70-3 package.</p> <p>c) MCP112-450E/TO: 4.5V option, push-pull, -40°C to +125°C, TO-92-3 package.</p>

## Sales and Support

### Data Sheets

Products supported by a preliminary Data Sheet may have an errata sheet describing minor operational differences and recommended workarounds. To determine if an errata sheet exists for a particular device, please contact one of the following:

1. Your local Microchip sales office
2. The Microchip Corporate Literature Center U.S. FAX: (480) 792-7277
3. The Microchip Worldwide Site ([www.microchip.com](http://www.microchip.com))

Please specify which device, revision of silicon and Data Sheet (include Literature #) you are using.

### Customer Notification System

Register on our web site ([www.microchip.com/cn](http://www.microchip.com/cn)) to receive the most current information on our products.

# MCP111/112

---

NOTES:

---

---

**Note the following details of the code protection feature on Microchip devices:**

- Microchip products meet the specification contained in their particular Microchip Data Sheet.
- Microchip believes that its family of products is one of the most secure families of its kind on the market today, when used in the intended manner and under normal conditions.
- There are dishonest and possibly illegal methods used to breach the code protection feature. All of these methods, to our knowledge, require using the Microchip products in a manner outside the operating specifications contained in Microchip's Data Sheets. Most likely, the person doing so is engaged in theft of intellectual property.
- Microchip is willing to work with the customer who is concerned about the integrity of their code.
- Neither Microchip nor any other semiconductor manufacturer can guarantee the security of their code. Code protection does not mean that we are guaranteeing the product as "unbreakable."

Code protection is constantly evolving. We at Microchip are committed to continuously improving the code protection features of our products. Attempts to break Microchip's code protection feature may be a violation of the Digital Millennium Copyright Act. If such acts allow unauthorized access to your software or other copyrighted work, you may have a right to sue for relief under that Act.

---

Information contained in this publication regarding device applications and the like is intended through suggestion only and may be superseded by updates. It is your responsibility to ensure that your application meets with your specifications. No representation or warranty is given and no liability is assumed by Microchip Technology Incorporated with respect to the accuracy or use of such information, or infringement of patents or other intellectual property rights arising from such use or otherwise. Use of Microchip's products as critical components in life support systems is not authorized except with express written approval by Microchip. No licenses are conveyed, implicitly or otherwise, under any intellectual property rights.

**Trademarks**

The Microchip name and logo, the Microchip logo, Accuron, dsPIC, KEELOQ, microID, MPLAB, PIC, PICmicro, PICSTART, PRO MATE, PowerSmart, rfPIC, and SmartShunt are registered trademarks of Microchip Technology Incorporated in the U.S.A. and other countries.


AmpLab, FilterLab, MXDEV, MXLAB, PICMASTER, SEEVAL, SmartSensor and The Embedded Control Solutions Company are registered trademarks of Microchip Technology Incorporated in the U.S.A.

Analog-for-the-Digital Age, Application Maestro, dsPICDEM, dsPICDEM.net, dsPICworks, ECAN, ECONOMONITOR, FanSense, FlexROM, fuzzyLAB, In-Circuit Serial Programming, ICSP, ICEPIC, Migratable Memory, MPASM, MPLIB, MPLINK, MPSIM, PICkit, PICDEM, PICDEM.net, PICLAB, PICtail, PowerCal, PowerInfo, PowerMate, PowerTool, rLAB, rfPICDEM, Select Mode, Smart Serial, SmartTel and Total Endurance are trademarks of Microchip Technology Incorporated in the U.S.A. and other countries.

SQTP is a service mark of Microchip Technology Incorporated in the U.S.A.

All other trademarks mentioned herein are property of their respective companies.

© 2004, Microchip Technology Incorporated, Printed in the U.S.A., All Rights Reserved.

 Printed on recycled paper.

**QUALITY MANAGEMENT SYSTEM**  
**CERTIFIED BY DNV**  
**== ISO/TS 16949:2002 ==**

*Microchip received ISO/TS-16949:2002 quality system certification for its worldwide headquarters, design and wafer fabrication facilities in Chandler and Tempe, Arizona and Mountain View, California in October 2003. The Company's quality system processes and procedures are for its PICmicro® 8-bit MCUs, KEELOQ® code hopping devices, Serial EEPROMs, microperipherals, nonvolatile memory and analog products. In addition, Microchip's quality system for the design and manufacture of development systems is ISO 9001:2000 certified.*



---

---

## WORLDWIDE SALES AND SERVICE

---

---

### AMERICAS

**Corporate Office**  
2355 West Chandler Blvd.  
Chandler, AZ 85224-6199  
Tel: 480-792-7200  
Fax: 480-792-7277  
Technical Support:  
480-792-7627  
Web Address:  
www.microchip.com

#### Atlanta

Alpharetta, GA  
Tel: 770-640-0034  
Fax: 770-640-0307

#### Boston

Westford, MA  
Tel: 978-692-3848  
Fax: 978-692-3821

#### Chicago

Itasca, IL  
Tel: 630-285-0071  
Fax: 630-285-0075

#### Dallas

Addison, TX  
Tel: 972-818-7423  
Fax: 972-818-2924

#### Detroit

Farmington Hills, MI  
Tel: 248-538-2250  
Fax: 248-538-2260

#### Kokomo

Kokomo, IN  
Tel: 765-864-8360  
Fax: 765-864-8387

#### Los Angeles

Mission Viejo, CA  
Tel: 949-462-9523  
Fax: 949-462-9608

#### San Jose

Mountain View, CA  
Tel: 650-215-1444  
Fax: 650-961-0286

#### Toronto

Mississauga, Ontario,  
Canada  
Tel: 905-673-0699  
Fax: 905-673-6509

### ASIA/PACIFIC

**Australia - Sydney**  
Tel: 61-2-9868-6733  
Fax: 61-2-9868-6755

**China - Beijing**  
Tel: 86-10-8528-2100  
Fax: 86-10-8528-2104

**China - Chengdu**  
Tel: 86-28-8676-6200  
Fax: 86-28-8676-6599

**China - Fuzhou**  
Tel: 86-591-750-3506  
Fax: 86-591-750-3521

**China - Hong Kong SAR**  
Tel: 852-2401-1200  
Fax: 852-2401-3431

**China - Shanghai**  
Tel: 86-21-6275-5700  
Fax: 86-21-6275-5060

**China - Shenzhen**  
Tel: 86-755-8290-1380  
Fax: 86-755-8295-1393

**China - Shunde**  
Tel: 86-757-2839-5507  
Fax: 86-757-2839-5571

**China - Qingdao**  
Tel: 86-532-502-7355  
Fax: 86-532-502-7205

### ASIA/PACIFIC

**India - Bangalore**  
Tel: 91-80-2229-0061  
Fax: 91-80-2229-0062

**India - New Delhi**  
Tel: 91-11-5160-8632  
Fax: 91-11-5160-8632

**Japan - Kanagawa**  
Tel: 81-45-471- 6166  
Fax: 81-45-471-6122

**Korea - Seoul**  
Tel: 82-2-554-7200  
Fax: 82-2-558-5932 or  
82-2-558-5934

**Singapore**  
Tel: 65-6334-8870  
Fax: 65-6334-8850

**Taiwan - Kaohsiung**  
Tel: 886-7-536-4816  
Fax: 886-7-536-4817

**Taiwan - Taipei**  
Tel: 886-2-2500-6610  
Fax: 886-2-2508-0102

**Taiwan - Hsinchu**  
Tel: 886-3-572-9526  
Fax: 886-3-572-6459

### EUROPE

**Austria - Weis**  
Tel: 43-7242-2244-399  
Fax: 43-7242-2244-393

**Denmark - Ballerup**  
Tel: 45-4420-9895  
Fax: 45-4420-9910

**France - Massy**  
Tel: 33-1-69-53-63-20  
Fax: 33-1-69-30-90-79

**Germany - Ismaning**  
Tel: 49-89-627-144-0  
Fax: 49-89-627-144-44

**Italy - Milan**  
Tel: 39-0331-742611  
Fax: 39-0331-466781

**Netherlands - Drunen**  
Tel: 31-416-690399  
Fax: 31-416-690340

**England - Berkshire**  
Tel: 44-118-921-5869  
Fax: 44-118-921-5820

08/24/04