

# ZMT Series Mini Size Sealed Snap-acting Switches

**NEW**



## Features/Benefits

- IP67 rating / Dust tight protection
- From 0.1A to 5A max. (ultra-low current available)
- Excellent sealed solution for modules mechanisms in Automotive and Medical applications
- UL / ENEC

## Typical Applications

- Automotive: door latch, seat position detection, EV charging
- Handheld devices (medical)
- Industrial equipment
- Consumer electronics

## Specifications

CONTACT RATING: 0.1A 125/250VAC 3A 24VDC  
 3A 125/250VAC 3A 24VDC  
 5A 125/250 VAC 3A 24VDC

ELECTRICAL LIFE: 10,000 cycles

ELECTRICAL OPERATING FREQUENCY: 10-30 operations per minute

MECHANICAL LIFE: 1,000,000 operations

MECHANICAL OPERATING FREQUENCY: 120 operations per minute

INSULATION RESISTANCE: Min. 100 MΩ ( 500 VDC/minute )  
 between Live-parts and dead metal parts

DIELECTRIC STRENGTH:  
 500VAC (50-60HZ)/minute between contacts  
 1500VAC (50-60HZ)/minute between Live-parts and dead metal parts

OPERATING TEMPERATURE: -40°C to 85°C (with no icing)

OPERATING FORCE: 200 grams

## Materials

CASE: PBT  
 COVER: PBT  
 BUTTON: PBT  
 MOVABLE CONTACTS: AG alloy  
 TERMINALS: AG alloy  
 LEVER: Stainless steel  
 WIRE: PVC+CU  
 LOWE CASE: Nylon  
 RUBBER SEAL: Silicon

## Build-A-Switch

Our easy build-a-switch concept allows you to mix and match options to create the switch you need. To order, select desired option from each category and place it in the appropriate box.

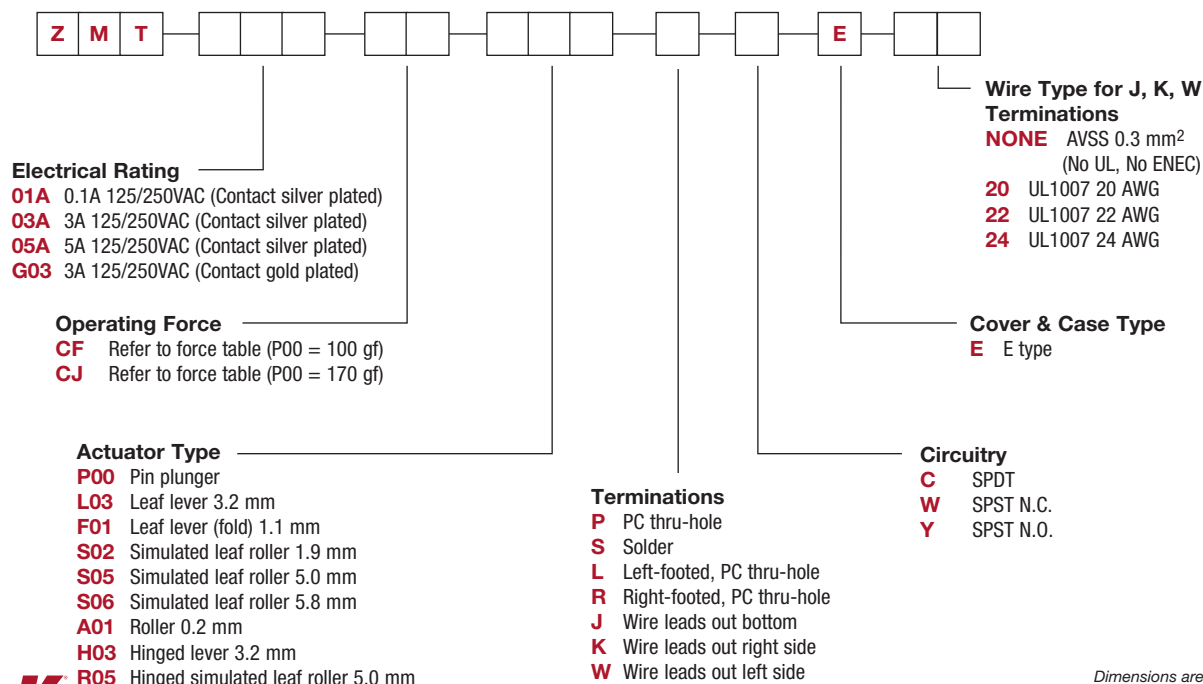

Snap-acting

**NEW**

# ZMT Series Mini Size Sealed Snap-acting Switches

## SERIES

**ZMT** MINI SIZE SEALED SNAP-ACTING SWITCHES - SP MOMENTARY

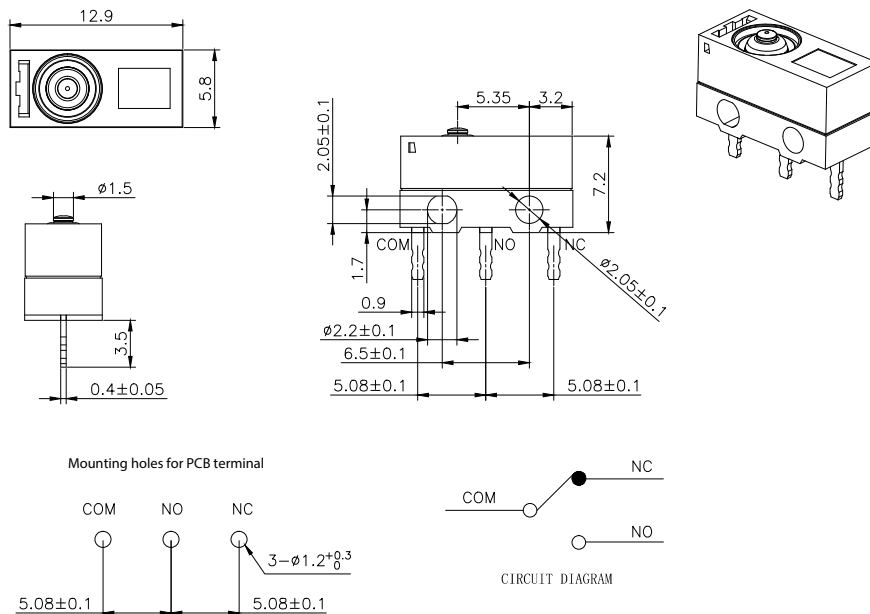

## ELECTRICAL RATING

Silver Contacts

ZMT	UL1054/UL1058
<b>01A</b>	0.1A 125/250VAC 3A 24VDC
<b>03A</b>	3A 125/250VAC 3A 24VDC
<b>05A</b>	5A 125/250VAC 3A 24VDC

Gold Contacts

ZMT	UL1054/UL1058
<b>G03</b>	3A 125/250VAC 3A 24VDC

- Note: See Technical Data in section N of this catalog for RoHS compliant and compatible definition and specifications.
- All models  with all options.
- Consult Customer Service center for availability and delivery of nonstandard ratings.

## OPERATING FORCE

OPERATING CODE	OPERATING FORCE AT THE BOTTOM (OZ / GRAMS)
<b>CF</b>	3.52 / 100
<b>CJ</b>	5.99 / 170



Dimensions are shown: mm  
Specifications and dimensions subject to change



Snap-acting

# ZMT Series Mini Size Sealed Snap-acting Switches

NEW

## ACTUATORS

**P00** PIN PLUNGER

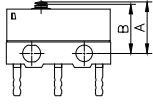

**S02** SIMULATED ROLLER 1.9 MM

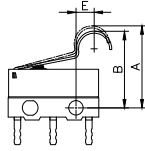

**F01** LEAF LEVER (FOLD) 1.1 MM

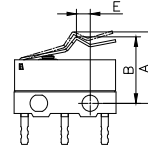

**L03** LEAF LEVER 3.2 MM

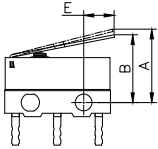

**S06** SIMULATED LEAF ROLLER 5.8 MM

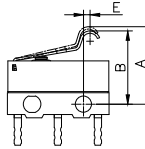

**R05** HINGED SIMULATED LEAF ROLLER 5.0 MM

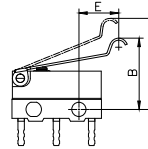

**S05** SIMULATED LEAF ROLLER 5.0 MM

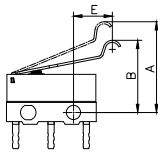

**H03** HINGED LEVER 3.2 MM

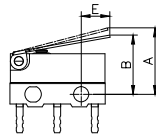

**A01** ROLLER 0.2 MM

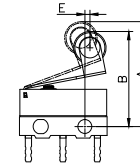

CODE	OPER. FORCE MAX.(gf)	REL. FORCE MIN.(gf)	A FP MAX. (mm)	B OP MAX. (mm)	C PT MAX. (mm)	D OT MIN. (mm)	E MIN. (mm)		
P00	100	170	21	35	6.4	5.9±0.2	0.5	0.2	-
L03	32	56	5	8	9.0	7.1±0.8	3.4	0.6	3.2
S05	28	48	5	7	13.1	9.1±0.8	3.5	0.7	5
F01	58	83	7	11	9.05	8.1±0.6	1.64	0.49	1.1
A01	45	55	4	8	15.45	13.0±1.1	3.5	0.1	0.2
S02	40	50	5	8	11.7	10.1±1.0	3.0	0.6	1.9
S06	45	65	5	12	9.85	8.5±0.8	1.8	0.25	0.1
H03	32	56	5	8	9.0	7.1±0.8	3.4	0.6	3.2
R05	28	48	5	7	13.1	9.1±0.8	3.5	0.7	5

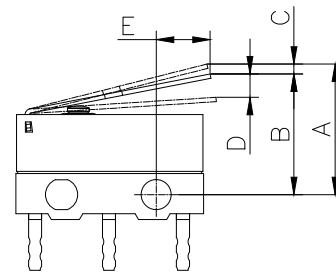

Snap-acting

NEW

# ZMT Series Mini Size Sealed Snap-acting Switches

## TERMINATIONS

### P PC THRU-HOLE

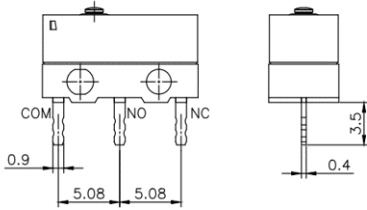

### S SOLDER

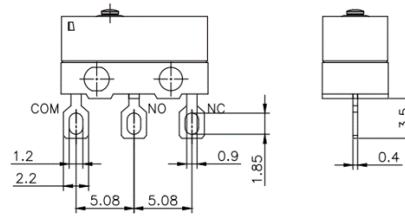

### L LEFT-FOOTED, PC THRU-HOLE

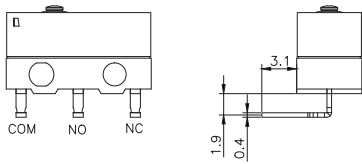

### R RIGHT-FOOTED, PC THRU-HOLE

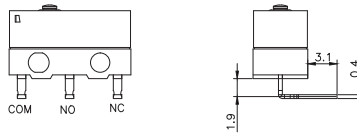

### J WIRE LEADS OUT BOTTOM

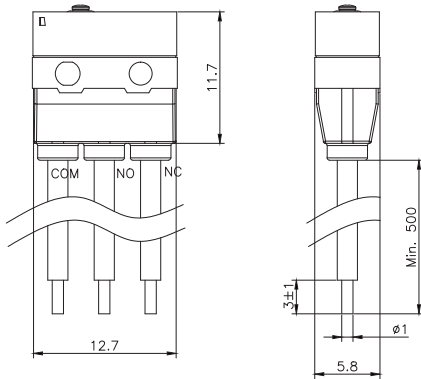

COM: UL1007 20AWG/22AWG/24AWG OR EQUIVALENT(BLACK)  
 NO: UL1007 20AWG/22AWG/24AWG OR EQUIVALENT(BLUE)  
 NC: UL1007 20AWG/22AWG/24AWG OR EQUIVALENT(GRAY)

### K WIRE LEADS OUT RIGHT SIDE

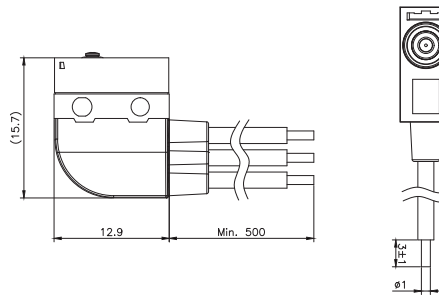

COM: UL1007 20AWG/22AWG/24AWG OR EQUIVALENT(BLACK)  
 NO: UL1007 20AWG/22AWG/24AWG OR EQUIVALENT(BLUE)  
 NC: UL1007 20AWG/22AWG/24AWG OR EQUIVALENT(GRAY)

### W WIRE LEADS OUT LEFT SIDE

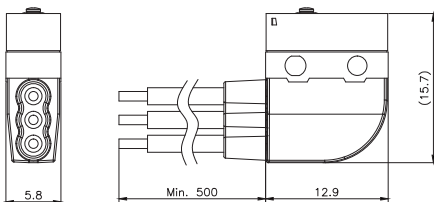

COM: UL1007 20AWG/22AWG/24AWG OR EQUIVALENT(BLACK)  
 NO: UL1007 20AWG/22AWG/24AWG OR EQUIVALENT(BLUE)  
 NC: UL1007 20AWG/22AWG/24AWG OR EQUIVALENT(GRAY)



# ZMT Series Mini Size Sealed Snap-acting Switches **NEW**

## CIRCUITRY

**C** SPDT

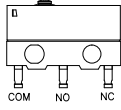

**Y** SPST NO

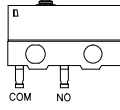

**W** SPST NC

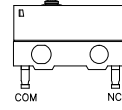

**Snap-acting**