

“Slim Line” Hybrid for PMC Sierra
0803-6500-01

FEATURES

- Supports PMC Sierra PM4318 chipset for T1/E1 long and short haul applications,
- Minimum board space requirement - ideal for multiple interface line cards
- Metallic protection circuit designed to meet Telcordia GR1089 for 1st level and 2nd level lightning and power line cross events
- Designed to meet supplementary isolation 1500V, working voltage 250V of UL60950

SCHEMATIC

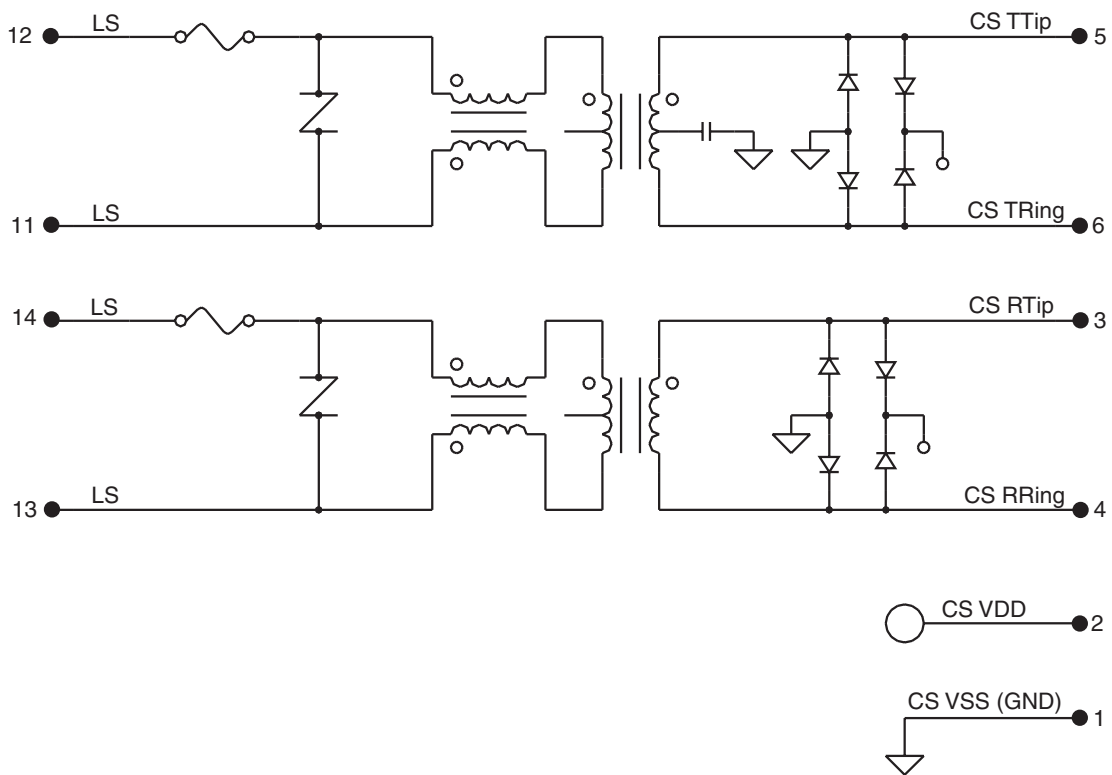



“Slim Line” Hybrid for PMC Sierra
0803-6500-01

SPECIFICATIONS @ 25° C

Turns Ratio ±2%		OCL mH typ	DCR Ω max	Cw/w pF max	Crosstalk dB typ	CMR dB min	Isolation Vrms
TX	RX	Chip Side	Chip Side		0.5 - 10MHz	TX 1- 50MHz	
1 : 2	1 : 2	1.2	0.7	30	-60	-50	1500

MECHANICAL

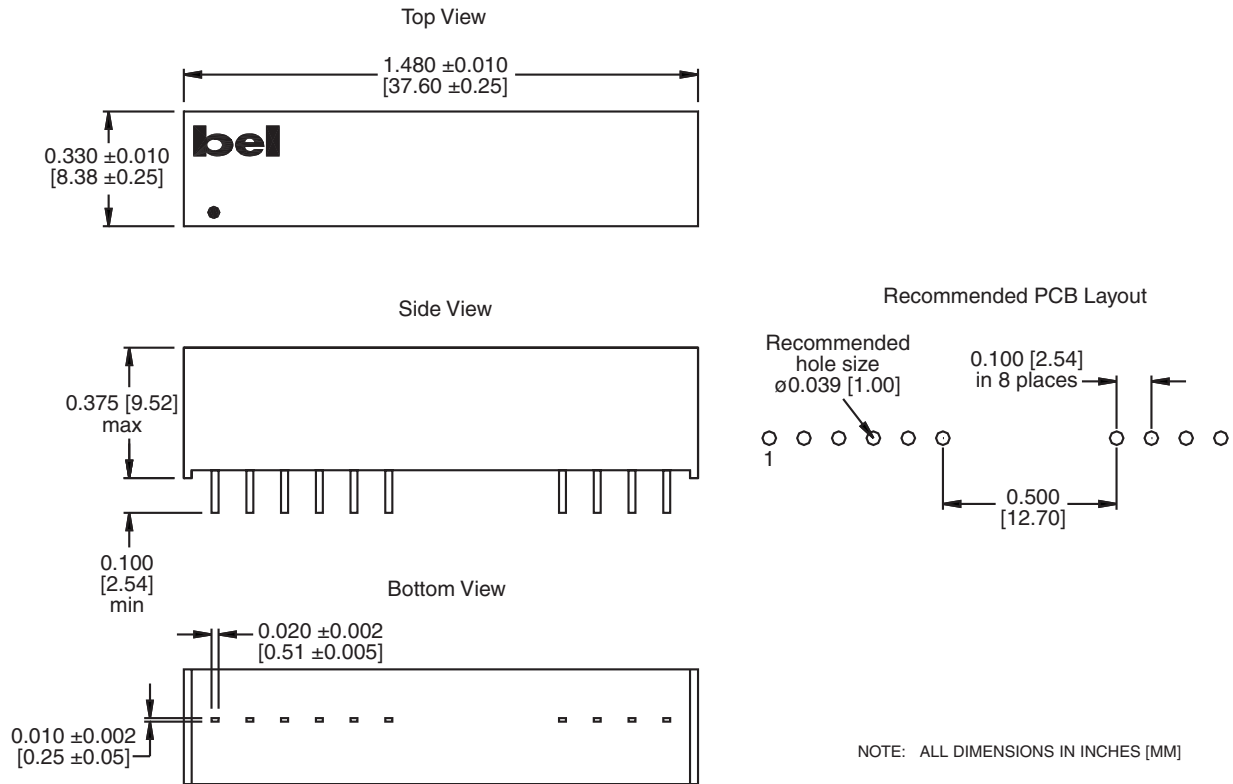

©2004 Bel Fuse Inc. Specifications subject to change without notice. 03.04.04

CORPORATE

Bel Fuse Inc.
 206 Van Vorst Street
 Jersey City, NJ 07302
 Tel 201-432-0463
 Fax 201-432-9542
 www.belfuse.com

FAR EAST

Bel Fuse Ltd.
 8F / 8 Luk Hop Street
 San Po Kong
 Kowloon, Hong Kong
 Tel 852-2328-5515
 Fax 852-2352-3706
 www.belfuse.com

EUROPE

Bel Stewart Connector
 45/46 Riverside
 Medway City Estate
 Rochester, Kent ME2 4DP U.K.
 Tel 44-1634-722890
 Fax 44-1634-716677
 www.belfuse.com