



ANALOG PERIPHERALS

- **10-bit ADC**
 - ±1LSB INL
 - Programmable Throughput up to 100ksps
 - 8 External Inputs; Programmable as Single-Ended or Differential
 - Programmable Amplifier Gain: 16, 8, 4, 2, 1, 0.5
 - Data Dependent Windowed Interrupt Generator
 - Built-in Temperature Sensor (± 3°C)
- **8-bit ADC**
 - Programmable Throughput up to 500ksps
 - 8 External Inputs
 - Programmable Amplifier Gain: 4, 2, 1, 0.5
- **Two 12-bit DACs**
 - Can Synchronize Outputs to Timers for Jitter-Free Waveform Generation
- **Two Comparators**
- **Internal Voltage Reference**
- **Precision VDD Monitor/Brown-out Detector**

ON-CHIP JTAG DEBUG & BOUNDARY SCAN

- On-Chip Debug Circuitry Facilitates Full Speed, Non-Intrusive In-System Debug (No Emulator Required!)
- Provides Breakpoints, Single Stepping, Watchpoints, Stack Monitor
- Inspect/Modify Memory and Registers
- Superior Performance to Emulation Systems Using ICE-Chips, Target Pods, and Sockets
- IEEE1149.1 Compliant Boundary Scan
- Low Cost, **Complete** Development Kit: \$129

HIGH SPEED 8051 µC CORE

- Pipe-lined Instruction Architecture; Executes 70% of Instructions in 1 or 2 System Clocks
- Up to 25MIPS Throughput with 25MHz System Clock
- 22 Vectored Interrupt Sources

MEMORY

- 4352 Bytes Internal Data RAM (256 + 4k)
- 64k Bytes In-System Programmable FLASH Program Memory
- External Parallel Data Memory Interface – up to 5Mbytes/sec

DIGITAL PERIPHERALS

- 64 Port I/O; All are 5V tolerant
- Hardware SMBus™ (I2C™ Compatible), SPI™, and **Two** UART Serial Ports Available Concurrently
- Programmable 16-bit Counter/Timer Array with 5 Capture/Compare Modules
- 5 General Purpose 16-bit Counter/Timers
- Dedicated Watch-Dog Timer; Bi-directional Reset

CLOCK SOURCES

- Internal Programmable Oscillator: 2-to-16MHz
- External Oscillator: Crystal, RC, C, or Clock
- Real-Time Clock Mode using Timer 3 or PCA

SUPPLY VOLTAGE 2.7V to 3.6V

- Typical Operating Current: 10mA @ 25MHz
- Multiple Power Saving Sleep and Shutdown Modes

100-Pin TQFP (64-Pin Version Available)

Temperature Range: -40°C to +85°C

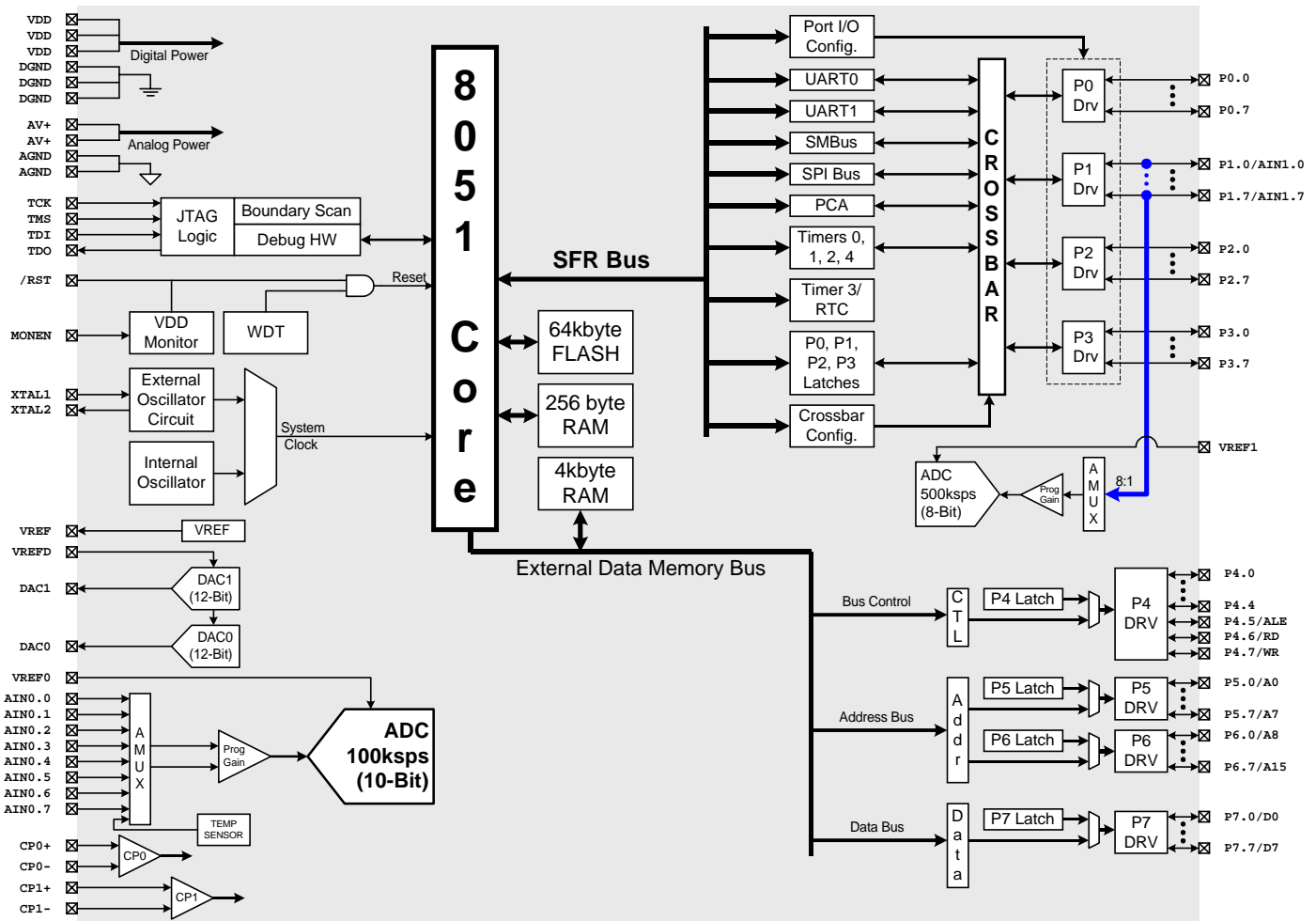



C8051F022

Mixed-Signal 64KB ISP FLASH MCU

PRELIMINARY

SELECTED ELECTRICAL SPECIFICATIONS TA = -40°C to +85°C unless otherwise specified.

PARAMETER	CONDITIONS	MIN	TYP	MAX	UNITS
GLOBAL CHARACTERISTICS					
Digital Supply Voltage		2.7		3.6	V
Digital Supply Current with CPU active (VDD=2.7V)	Clock=25MHz		10		mA
	Clock=1MHz		0.8		mA
	Clock=32kHz; VDD Monitor Disabled		20		μA
Digital Supply Current (shutdown)	Oscillator not running; VDD Monitor Enabled		10		μA
	Oscillator not running; VDD Monitor Disabled		0.1		μA
Digital Supply RAM Data Retention Voltage			1.5		V
CPU & DIGITAL I/O PORTS					
Clock Frequency Range		DC		25	MHz
Port Output High Voltage	I _{OH} = -3mA, Port I/O push-pull	VDD - 0.7			V
Port Output Low Voltage	I _{OL} = 8.5mA			0.6	V
Input High Voltage		0.7 x VDD			V
Input Low Voltage				0.3 x VDD	V
A/D CONVERTER					
Resolution			10		bits
Integral Nonlinearity				± 1	LSB
Differential Nonlinearity	Guaranteed Monotonic			± 1	LSB
Signal-to-Noise Plus Distortion		59			dB
Throughput Rate				100	ksps
Input Voltage Range		0		VREF	V
COMPARATORS					
Response Time	CP+ - CP- = 100mV		4		μs
Input Voltage Range		-0.25		VDD + 0.25	V
Input Bias Current		-5	0.001	+5	nA
Input Offset Voltage		-10		+10	mV

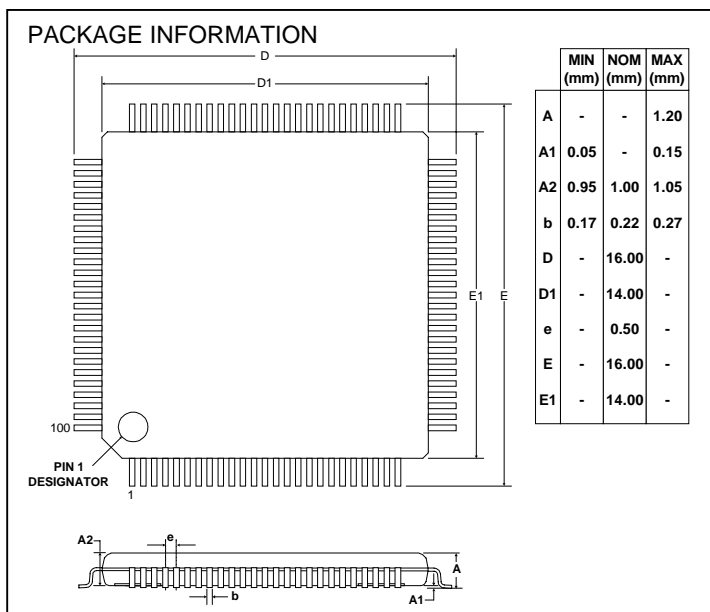

C8051F020DK DEVELOPMENT KIT (\$129)

