

160-2043 Solder terminal, turreted,

Recommended mounting hole .076 (1,93), #48 drill

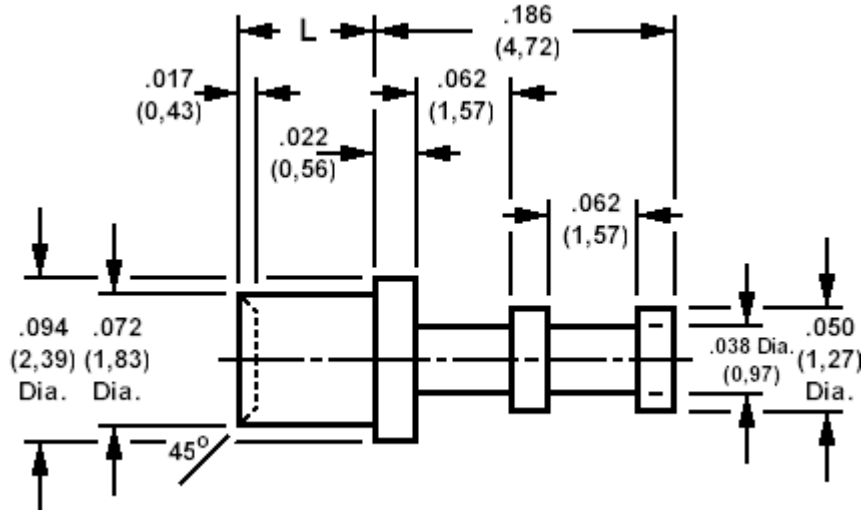

How to order code

160-2043-XX-YY-00

Basic Part No XX = L dimension, YY = Plating Finish

DIMENSIONS (XX)			
Basic Part No	(XX)	L	Board Thickness
160-2043	-01	.051 (1,29)	.031 (0,79)
	-02	.082 (2,08)	.062 (1,59)
	-03	.113 (2,87)	.094 (2,38)
	-04	.145 (3,68)	.125 (3,18)

MATERIALS			
Component	Material	Finish (YY)	
		-01	-05
Terminal	Brass	Silver	Electro Solder

SWAGE TOOLING	
Recommended Swaging Tools:-	
Anvil	435-6420-01-00-00
Roll punch	435-6617-01-00-00