

### Features

- N channel
- Enhancement mode
- Temperature sensor with thyristor characteristic
- The drain pin is electrically shorted to the tab

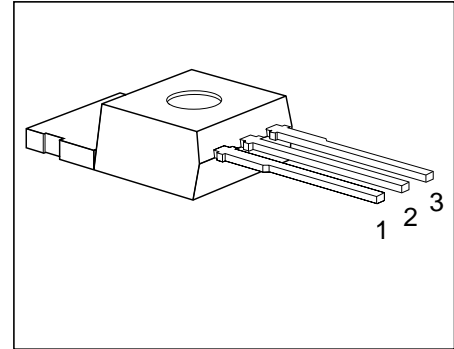

Pin	1	2	3
	G	D	S

Type	$V_{DS}$	$I_D$	$R_{DS(on)}$	Package	Ordering Code
BTS 129	60 V	27 A	0.05 $\Omega$	TO-220AB	C67078-A5013-A2

### Maximum Ratings

Parameter	Symbol	Values	Unit
Drain-source voltage	$V_{DS}$	60	V
Drain-gate voltage, $R_{GS} = 20 \text{ k}\Omega$	$V_{DGR}$	60	
Gate-source peak voltage, aperiodic	$V_{gs}$	$\pm 20$	
Continuous drain current, $T_C = 25 \text{ }^\circ\text{C}$	$I_D$	27	A
ISO drain current $T_C = 85 \text{ }^\circ\text{C}$ , $V_{GS} = 10 \text{ V}$ , $V_{DS} = 0.5 \text{ V}$	$I_{D-ISO}$	7.5	
Pulsed drain current, $T_C = 25 \text{ }^\circ\text{C}$	$I_{D \text{ puls}}$	108	
Short circuit current, $T_j = -55 \dots +150 \text{ }^\circ\text{C}$	$I_{SC}$	80	
Short circuit dissipation, $T_j = -55 \dots +150 \text{ }^\circ\text{C}$	$P_{SCmax}$	1200	W
Power dissipation	$P_{tot}$	75	
Operating and storage temperature range	$T_j, T_{stg}$	$-55 \dots +150$	$^\circ\text{C}$
DIN humidity category, DIN 40 040	–	E	–
IEC climatic category, DIN IEC 68-1	–	55/150/56	
Thermal resistance			K/W
Chip-case	$R_{th \text{ JC}}$	$\leq 1.67$	
Chip-ambient	$R_{th \text{ JA}}$	$\leq 75$	

## Electrical Characteristics

at  $T_j = 25\text{ °C}$ , unless otherwise specified.

Parameter	Symbol	Values			Unit
		min.	typ.	max.	

## Static Characteristics

Drain-source breakdown voltage $V_{GS} = 0, I_D = 0.25\text{ mA}$	$V_{(BR)DSS}$	60	–	–	V
Gate threshold voltage $V_{GS} = V_{DS}, I_D = 1\text{ mA}$	$V_{GS(th)}$	2.5	3.0	3.5	
Zero gate voltage drain current $V_{GS} = 0\text{ V}, V_{DS} = 60\text{ V}$ $T_j = 25\text{ °C}$ $T_j = 150\text{ °C}$	$I_{DSS}$	– –	1 100	10 300	$\mu\text{A}$
Gate-source leakage current $V_{GS} = 20\text{ V}, V_{DS} = 0$ $T_j = 25\text{ °C}$ $T_j = 150\text{ °C}$	$I_{GSS}$	– –	10 2	100 4	nA $\mu\text{A}$
Drain-source on-state resistance $V_{GS} = 10\text{ V}, I_D = 17\text{ A}$	$R_{DS(on)}$	–	0.04	0.05	$\Omega$

## Dynamic Characteristics

Forward transconductance $V_{DS} \geq 2 \times I_D \times R_{DS(on)max}, I_D = 17\text{ A}$	$g_{fs}$	8.0	13.0	18.0	S
Input capacitance $V_{GS} = 0, V_{DS} = 25\text{ V}, f = 1\text{ MHz}$	$C_{iss}$	700	940	1250	$\mu\text{F}$
Output capacitance $V_{GS} = 0, V_{DS} = 25\text{ V}, f = 1\text{ MHz}$	$C_{oss}$	–	500	750	
Reverse transfer capacitance $V_{GS} = 0, V_{DS} = 25\text{ V}, f = 1\text{ MHz}$	$C_{rss}$	–	180	270	
Turn-on time $t_{on}$ , ( $t_{on} = t_{d(on)} + t_r$ ) $V_{CC} = 30\text{ V}, V_{GS} = 10\text{ V}, I_D = 3\text{ A}, R_{GS} = 50\text{ }\Omega$	$t_{d(on)}$	–	25	40	ns
	$t_r$	–	60	90	
Turn-off time $t_{off}$ , ( $t_{off} = t_{d(off)} + t_f$ ) $V_{CC} = 30\text{ V}, V_{GS} = 10\text{ V}, I_D = 3\text{ A}, R_{GS} = 50\text{ }\Omega$	$t_{d(off)}$	–	100	130	
	$t_f$	–	75	95	

## Electrical Characteristics (cont'd)

at  $T_j = 25\text{ °C}$ , unless otherwise specified.

Parameter	Symbol	Values			Unit
		min.	typ.	max.	

### Reverse Diode

Continuous source current	$I_S$	–	–	27	A
Pulsed source current	$I_{SM}$	–	–	108	
Diode forward on-voltage $I_F = 54\text{ A}$ , $V_{GS} = 0$	$V_{SD}$	–	1.5	2.0	V
Reverse recovery time $I_F = I_S$ , $di_F/dt = 100\text{ A}/\mu\text{s}$ , $V_R = 30\text{ V}$	$t_{rr}$	–	150	–	ns
Reverse recovery charge $I_F = I_S$ , $di_F/dt = 100\text{ A}/\mu\text{s}$ , $V_R = 30\text{ V}$	$Q_{rr}$	–	1.0	–	$\mu\text{C}$

### Temperature Sensor

Forward voltage $I_{TS(on)} = 10\text{ mA}$ , $T_j = -55 \dots +150\text{ °C}$ Sensor override, $t_p \leq 100\text{ }\mu\text{s}$ $T_j = -55 \dots +160\text{ °C}$	$V_{TS(on)}$	0.7	1.4	1.5	V
		–	–	10	
Forward current $T_j = -55 \dots +150\text{ °C}$ Sensor override, $t_p \leq 100\text{ }\mu\text{s}$ $T_j = -55 \dots +160\text{ °C}$	$I_{TS(on)}$	–	–	10	mA
		–	–	600	
Holding current, $V_{TS(off)} = 5\text{ V}$ , $T_j = 25\text{ °C}$ $T_j = 150\text{ °C}$	$I_H$	0.05 0.05	0.1 0.2	0.5 0.3	
Switching temperature $V_{TS} = 5\text{ V}$	$T_{TS(on)}$	150	–	–	$\text{°C}$
Turn-off time $V_{TS} = 5\text{ V}$ , $I_{TS(on)} = 2\text{ mA}$	$t_{off}$	0.5	–	2.5	$\mu\text{s}$

**Examples for short-circuit protection**

at  $T_j = -55 \dots +150 \text{ }^\circ\text{C}$ , unless otherwise specified.

Parameter	Symbol	Examples			Unit
		1	2	–	
Drain-source voltage	$V_{DS}$	15	30	–	V
Gate-source voltage	$V_{GS}$	8.1	5.9	–	
Short-circuit current	$I_{SC}$	$\leq 80$	$\leq 37$	–	A
Short-circuit dissipation	$P_{SC}$	1200	1100	–	W
Response time $T_j = 25 \text{ }^\circ\text{C}$ , before short circuit	$t_{SC(off)}$	25	25	–	ms

**Short-circuit protection  $I_{SC} = f(V_{DS})$**

Parameter:  $V_{GS}$

Diagram to determine  $I_{SC}$  for  $T_j = -55 \dots +150 \text{ }^\circ\text{C}$

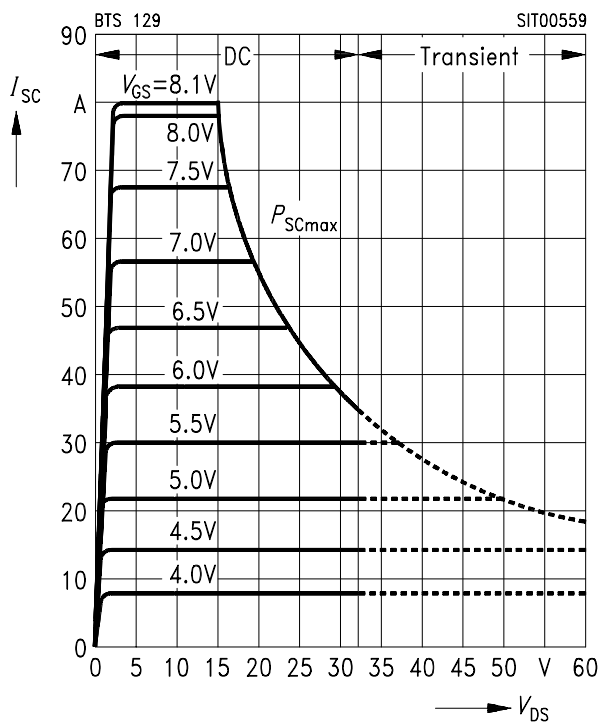

**Max. gate voltage  $V_{GS(SC)} = f(V_{DS})$**

Parameter:  $T_j = -55 \dots +150 \text{ }^\circ\text{C}$

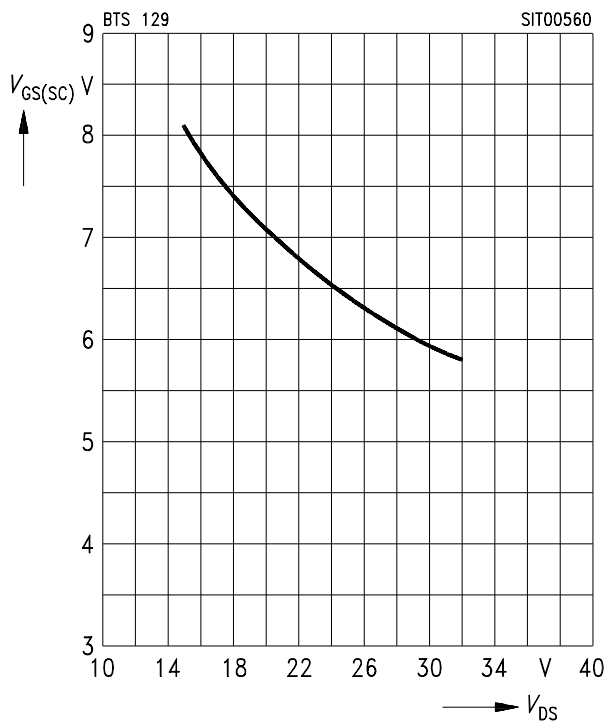

**Typical output characteristics**  $I_D = f(V_{DS})$   
 Parameter:  $t_p = 80 \mu s$

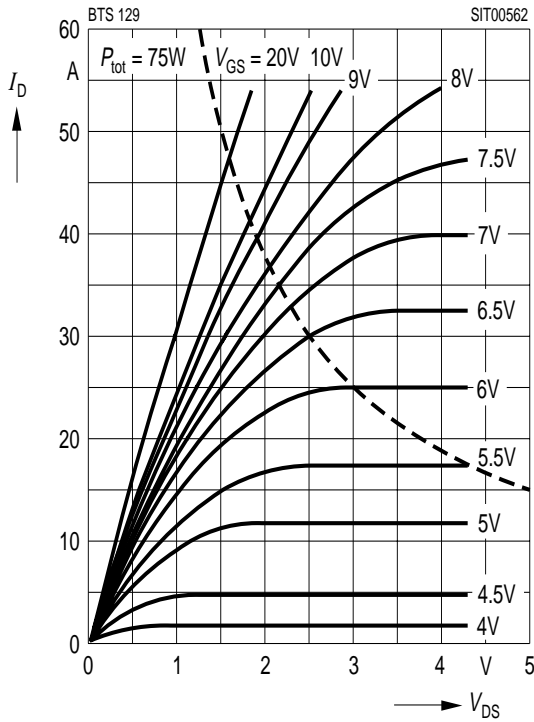

**Safe operating area**  $I_D = f(V_{DS})$   
 Parameter:  $D = 0.01, T_C = 25^\circ C$

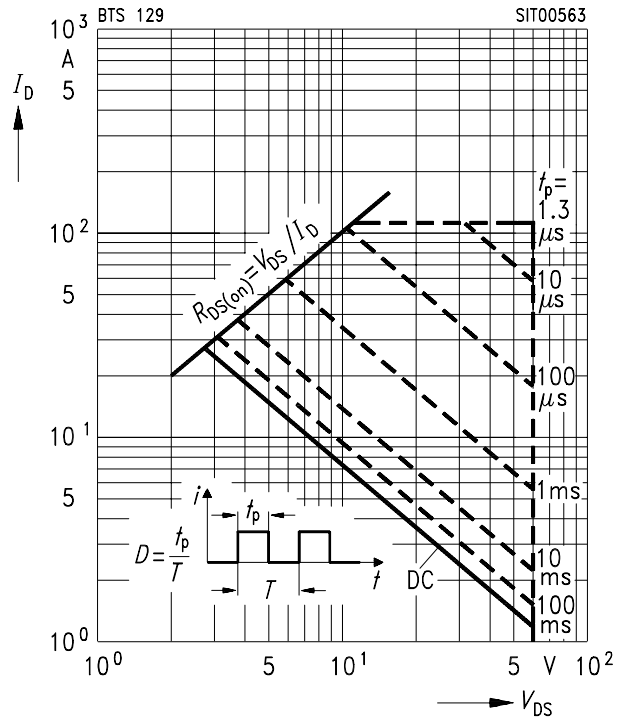

**Typ. drain-source on-state resistance**  
 $R_{DS(on)} = f(I_D)$   
 Parameter:  $V_{GS}$

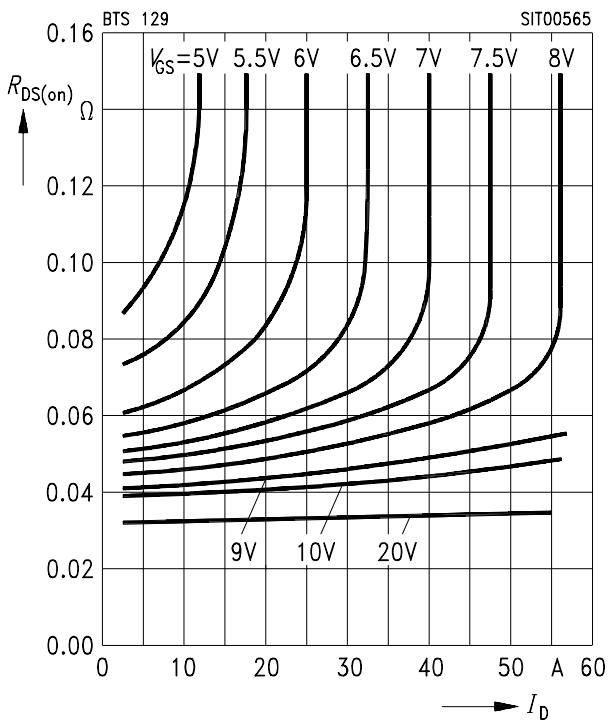

**Drain-source on-state resistance**  
 $R_{DS(on)} = f(T_j)$   
 Parameter:  $I_D = 17 A, V_{GS} = 10 V$  (spread)

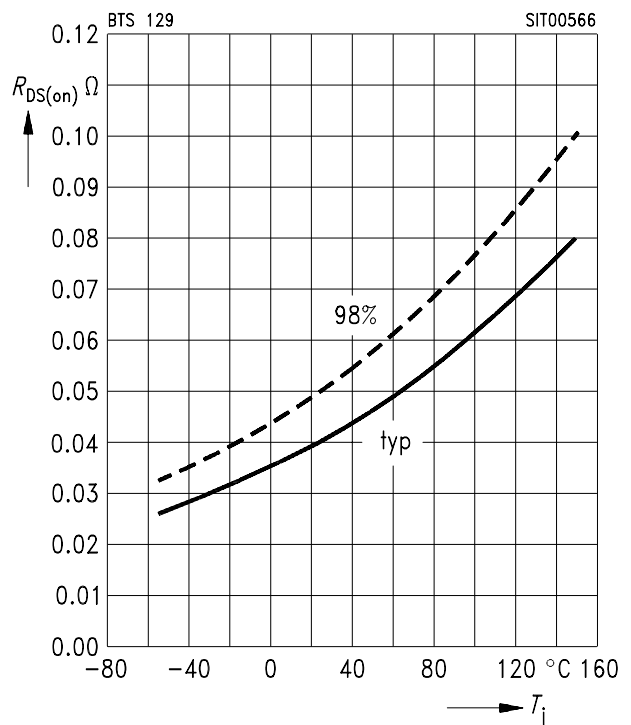

**Typ. transfer characteristic**

$I_D = f(V_{GS})$

Parameter:  $t_p = 80 \mu s, V_{DS} = 25 V$

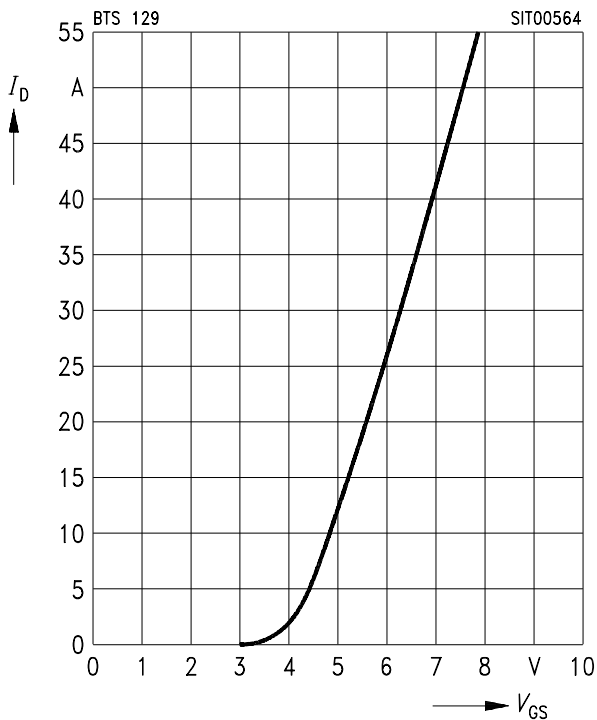

**Typ. transconductance  $g_{fs} = f(I_D)$**

Parameter:  $t_p = 80 \mu s, V_{DS} = 25 V$

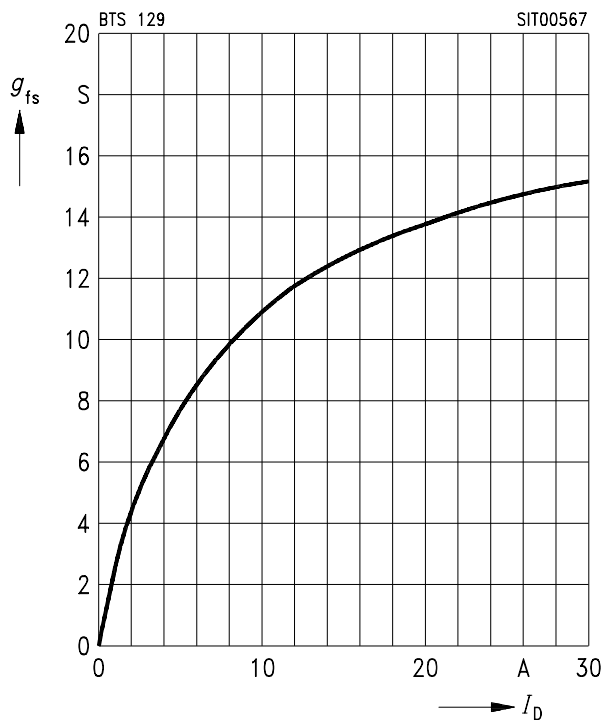

**Gate threshold voltage  $V_{GS(th)} = f(T_j)$**

Parameter:  $V_{DS} = V_{GS}, I_D = 1 mA$

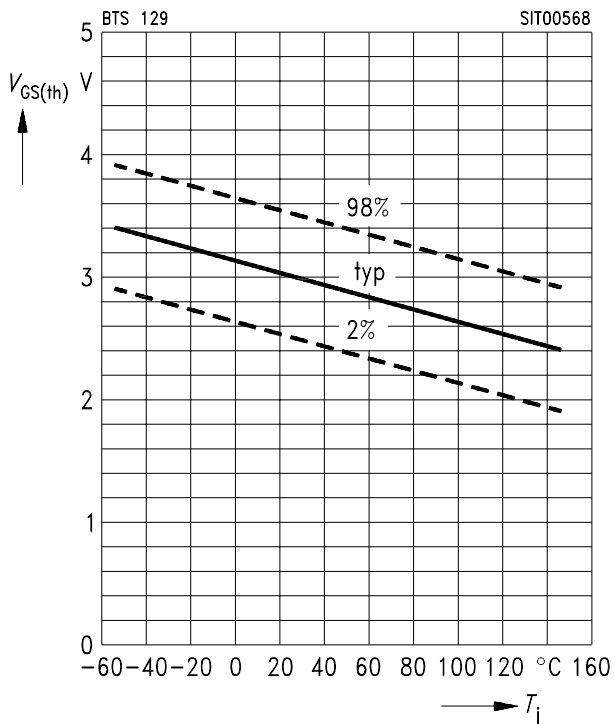

**Continuous drain current  $I_D = f(T_C)$**

Parameter:  $V_{GS} \geq 10 V$

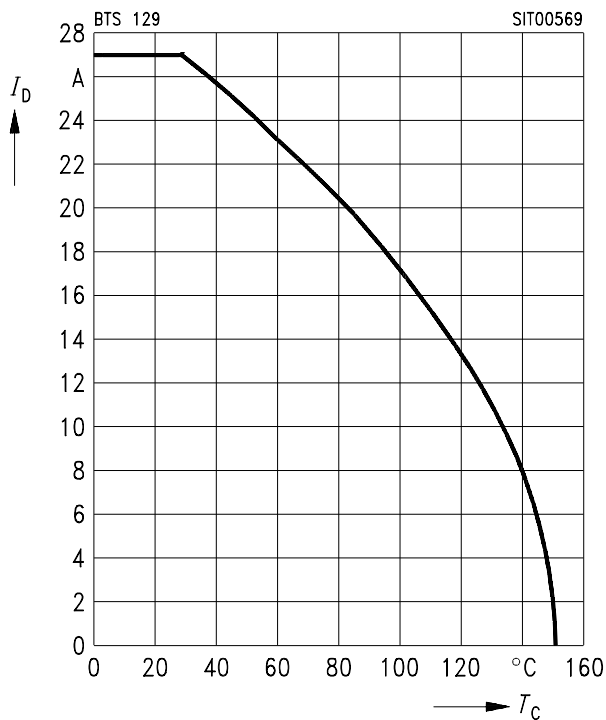

**Typ. gate-source leakage current**

$I_{GSS} = f(T_C)$

Parameter:  $V_{GS} = 20\text{ V}$ ,  $V_{DS} = 0$

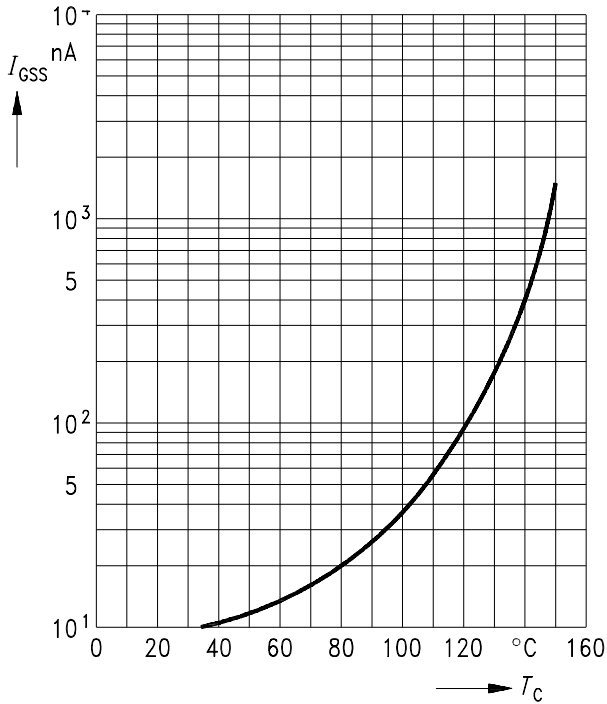

**Typ. capacitances  $C = f(V_{DS})$**

Parameter:  $V_{GS} = 0$ ,  $f = 1\text{ MHz}$

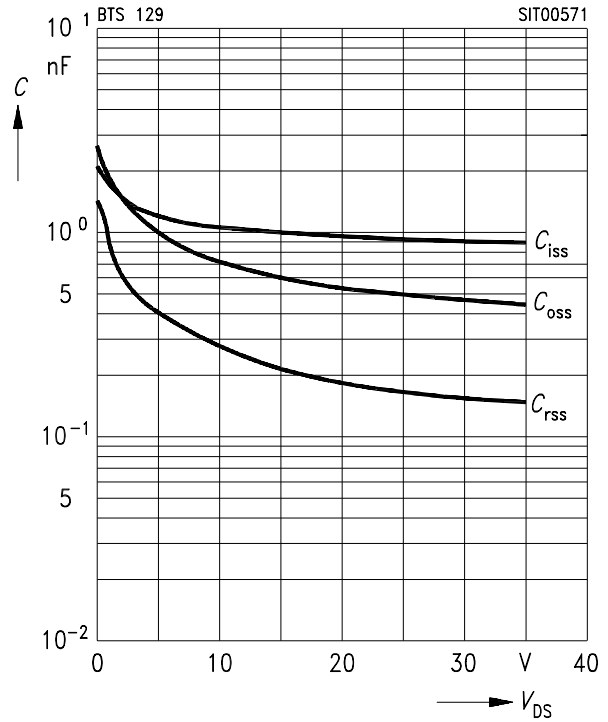

**Forward characteristics of reverse diode**

$I_F = f(V_{SD})$

Parameter:  $T_j, t_p = 80\ \mu\text{s}$

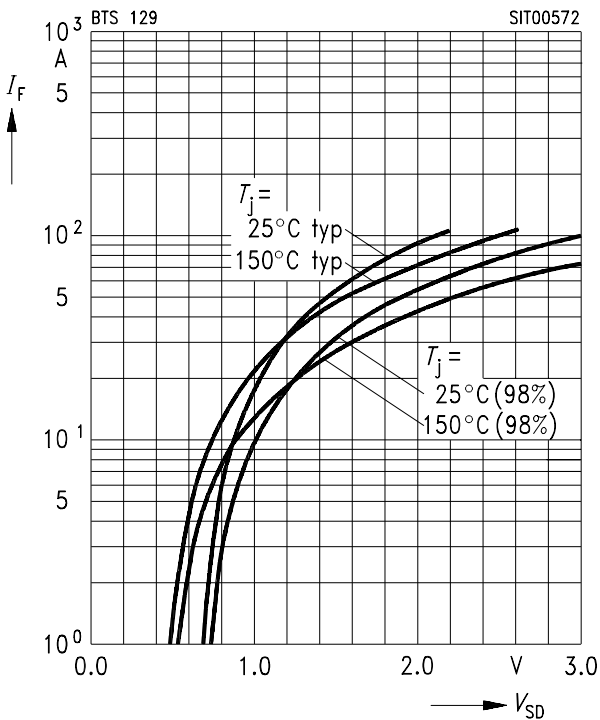

**Transient thermal impedance  $Z_{thJC} = f(t_p)$**

Parameter:  $D = t_p/T$

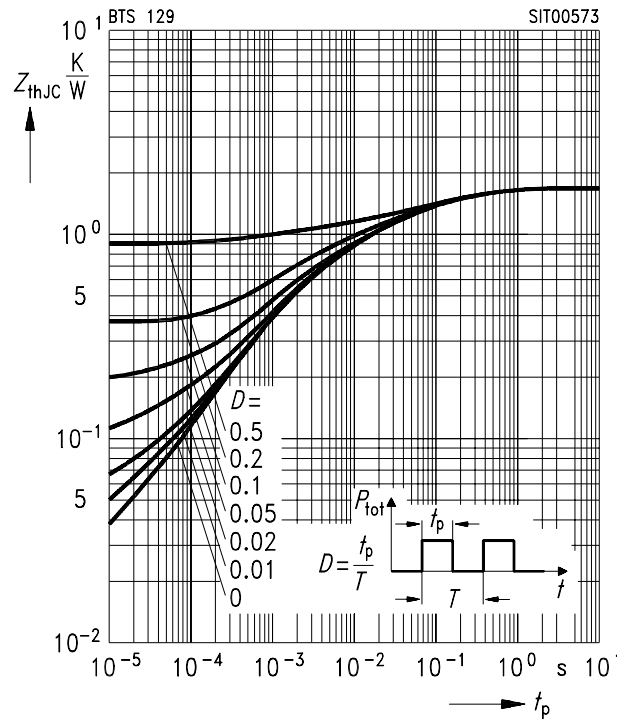

**TO 220 AB**  
Standard

**Ordering Code**  
C67078-A5013-A2

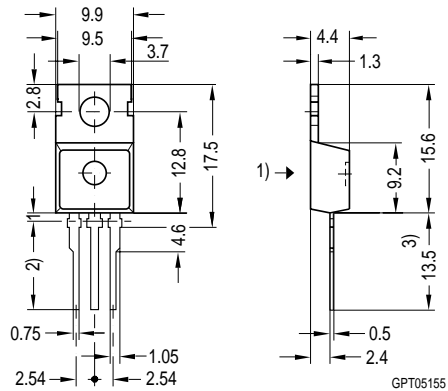

- 1) punch direction, burr max. 0.04
- 2) dip tinning
- 3) max. 14.5 by dip tinning press burr max. 0.05