

SMTC3-2500



Phase Control Thyristor



Type	V_{RSM}	V_{RRM} , V_{DRM}
SMTC3-2500-24	2500	2400
SMTC3-2500-26	2700	2600
SMTC3-2500-28	2900	2800
SMTC3-2500-30	3100	3000
SMTC3-2500-32	3300	3200
SMTC3-2500-34	3500	3400
SMTC3-2500-36	3700	3600

Type	I_{TAVM} $T_c=55^\circ\text{C}$	I_{TRMS}	I_{TSM}	$(di/dt)_{cr}$	$(dv/dt)_{cr}$	V_{TM}	I_{TM}	V_{TO}	r_T	t_q	V_{GT}	I_{GT}	T_{VJM}	R_{thJC}	F
	A	kA	kA	A/ μs	V/ μs	V	kA	V	m Ω	μs	V	mA	$^\circ\text{C}$	K/W	kN
SMTC3-2500	2500	4.3	30.1	250	1000	2.35	5.0	1.10	0.22	500	3.0	300	125	0.011	45

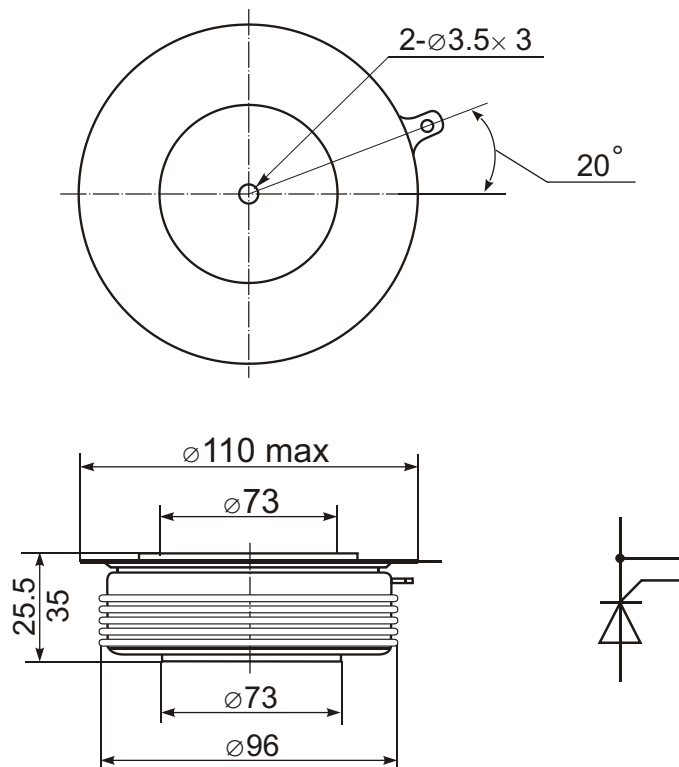

Features:

- Hermetic metal case with ceramic insulator
- Capsule packages for double sided cooling
- International standard case
- Amplifying gates

Typical Applications:

- DC motor control
- AC motor soft starter
- Controlled rectifiers
- AC controllers