



FEATURES

- High Output Voltage: $\pm 140V$
- High CMR: 100dB min
- Operates With a Wide Range of Power Supplies
- High CMV: $\pm(|V_S| - 10V)$

APPLICATIONS

- High Voltage Compliance Current Source
- High Voltage Follower With Gain
- High Voltage Integrator
- Diff. Amp for High CMV Bridge Applications
- Reference Power Supply



GENERAL DESCRIPTION

Model 171 is a high performance FET input op amp designed for operation over a wide range of supply voltages. This module features an output range of $\pm 15V$ to $\pm 140V$ at 10mA, a minimum CMRR of 100dB and a high common mode voltage rating of $\pm(V_S - 10V)$ min. DC offset is less than $\pm 1mV$, and maximum drift of either ± 50 or $\pm 15\mu V/^\circ C$ is available in the J or K versions. Bias current is less than 50pA (171J) or 20pA (171K), doubling per $+10^\circ C$ increase of temperature. The model 171 also features small signal bandwidth of 3MHz for unity gain, full-power bandwidth of 15kHz, and slew rate of $10V/\mu s$.

These operating characteristics make model 171 an excellent choice for high voltage buffer applications, followers with gain, off-ground signal measurements and reference power supplies.

Excellent power supply rejection of $7\mu V/V$ enables model 171 to be powered by inexpensive, low regulation supplies, without sacrificing any of the 171's inherent high performance. The supplies also need not be symmetrical. Any combination of power supply voltages between the limits of 15 to +300V for the positive side and 15 to -300V for negative side is acceptable provided the total voltage across the amplifier is within the range of 30 to 300V.

Model 171's output is completely short circuit protected by the use of a current limit scheme. This type of protection provides a short circuit output that is only slightly greater than the rated output current for normal operation. With this design the module and external circuitry are protected, internal heat dissipation and the associated high temperature rise are limited, and added reliability is built in.

POWER SUPPLY VOLTAGES

Model 171 offers the flexibility of operating with an extensive range and combination of power supply voltages. Figure 1 shows a chart of permissible combinations of supply voltages for the 171. The model 171 maintains its normal operating characteristics when using asymmetrical power supply configurations.

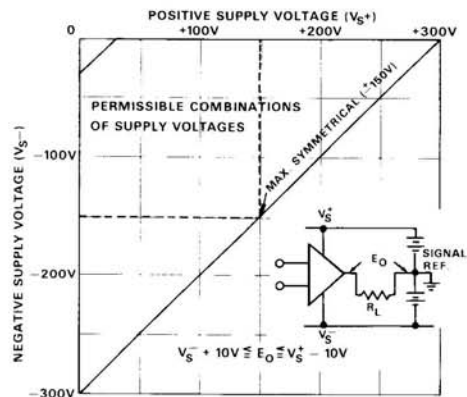

Figure 1. Power Supply Voltage Combinations

(continued on page 3)

SPECIFICATIONS

(typical @ +25°C and ±125V unless otherwise noted)

MODEL	171J	171K
OPEN LOOP GAIN	10 ⁶ min	*
RATED OUTPUT		
Voltage, min	±(V _S -10V)	*
Current, min	10mA	*
Load Capacitance, min	1000pF	*
FREQUENCY RESPONSE		
Unity Gain, Small Signal	3MHz	*
Slewing Rate, min	10V/μsec	*
Full Power, min	15kHz	*
Settling to 0.1%, 10 Volt Step	25μsec	*
Overload Recovery	5μsec	*
INPUT OFFSET VOLTAGE		
Initial Offset, +25°C ¹	1mV	*
Avg. vs. Temp (0 to +70°C) max	50μV/°C	15μV/°C
vs. Supply Voltage	7μV/V	*
vs. Time	250μV/mo	*
INPUT BIAS CURRENT		
Initial Bias, +25°C, max	50pA	-20pA
vs. Temp	x 2/10°C	*
Difference Current	10pA	5pA
INPUT IMPEDANCE		
Differential	10 ¹¹ Ω 3.5pF	*
Common Mode	10 ¹¹ Ω 3.5pF	*
INPUT NOISE		
Voltage, 0.01 to 1.0Hz, p-p	4μV	*
10Hz to 10kHz, rms	2.5μV	*
5Hz to 50kHz, rms	6μV	*
INPUT VOLTAGE RANGE		
Common Mode Voltage, min	±(V _S -10V)	*
Common Mode Rejection, min	100dB	*
Common Mode Rejection, typ	114dB	*
Max Safe Differential Voltage	±V _S	*
POWER SUPPLY		
Voltage, Rated Specification	±25 to ±150VDC	*
Voltage, Operating	±15 to ±150VDC	*
Current, Quiescent, typ	6mA	*
TEMPERATURE RANGE		
Rated Specification	0 to +70°C	*
Operating	-25°C to +85°C	*
Storage	-40°C to +100°C	*
MECHANICAL		
Case Size	2.41" x 1.82" x 0.61"	*
Weight	80g	*
Mating Socket	AC1037	*

*Specifications same as 171J

¹ No external trim connection required.

Specifications subject to change without notice.

OUTLINE DIMENSIONS

Dimensions shown in inches and (mm).

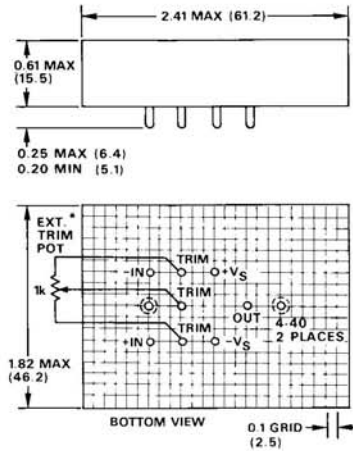

NOTES:

1. Pins: 0.040 +0.002 dia., spherical radius on ends, half-hard -0.000 brass: gold plated.
2. Markings next to pins and grid are for reference only and do not appear on unit.

*Available from Analog Devices — #79 PR1K

MATING SOCKET

Dimensions shown in inches and (mm).

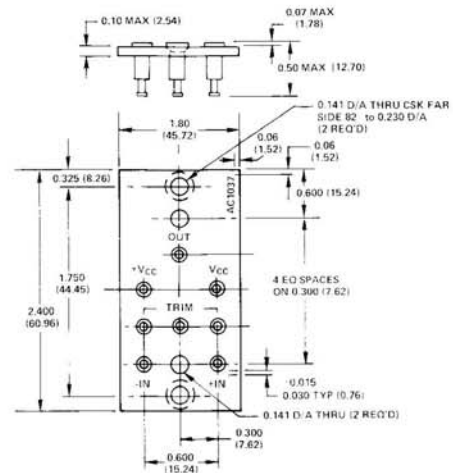

MATING SOCKET AC1037

(continued from page 1)

As shown in Figure 1, the model 171 requires at least ± 15 volts applied across it in order to operate properly. The 171 may be operated from a single floating supply voltage by using the power supply offsetting scheme shown in Figure 2. When this configuration is used, the 171 is capable of operating over its specified input and output voltage range.

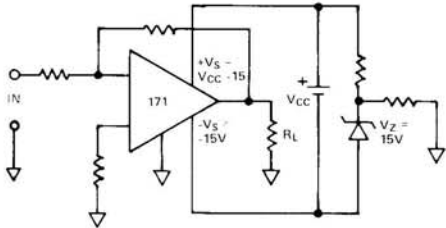

Figure 2. Single Supply Operation

FREQUENCY RESPONSE

Figure 3 shows a plot of open loop gain and phase shift as a function of frequency for model 171. It can be seen that the model 171 is stable for all closed loop gains. At the crossover frequency, model 171 typically displays a phase margin of 85° .

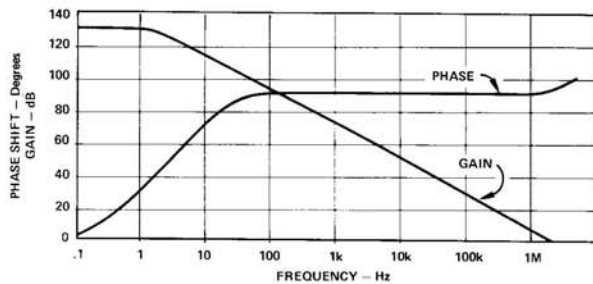

Figure 3. Gain and Phase Shift vs. Frequency

The open loop dc gain of the model 171 does not change appreciably as the power supply voltage is varied (see Figure 4). Open loop gain is typically greater than 106dB over the full power supply voltage range. Figures 3 and 4 show that excellent closed loop accuracy is assured over a great range of frequency and supply voltage when using the 171.

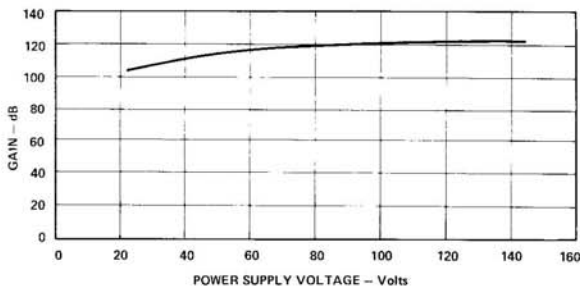

Figure 4. Open Loop DC Gain vs. Power Supply Voltage

COMMON MODE REJECTION RATIO

Common mode rejection is an important parameter in measurements requiring the amplification of small differential signals riding on high common-mode voltage levels. Model 171

is characterized by a minimum CMR of 100dB over its specified power supply voltage range. For the 171, CMR increases above this minimum value as the power supply voltage is raised. Figure 5 shows CMR as a function of supply voltage for model 171. The 171 also is capable of handling common-mode voltages up to 140 volts (with maximum supply voltages).

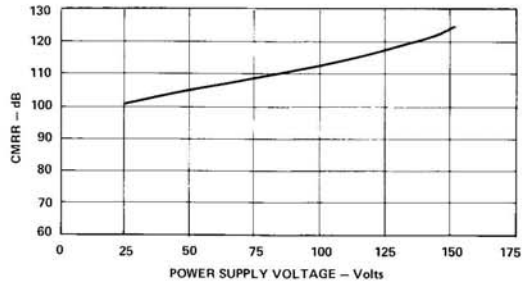

Figure 5. CMRR vs. Power Supply Voltage

OFFSET VOLTAGE

Model 171 provides excellent power supply rejection of $7\mu\text{V}/\text{V}$ and guaranteed input offset voltage drift of $15\mu\text{V}/^\circ\text{C}$ (171K). The combination of these two characteristics, along with its gain and common mode performance, help make the model 171 an accurate and stable source of high voltage signals. Figure 6 shows input offset vs. power supply voltage for the 171. Supply rejection is fairly constant and is not dependent upon the power supply voltage level.

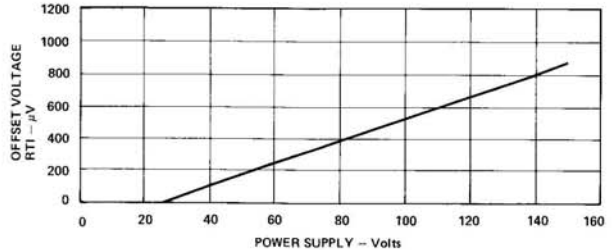

Figure 6. Input Offset Voltage vs. Power Supply Voltage

BIAS CURRENT

The input bias current for the model 171 is specified to be 50pA, max for the J version and 20pA, max for the K version. These specifications are guaranteed over the normal range of common mode voltage. Bias current is a function of CMV and decreases as the CMV approaches zero volts. Figure 7 shows bias current vs. CMV for model 171K. Notice that with zero CMV the bias current is typically less than 3pA.

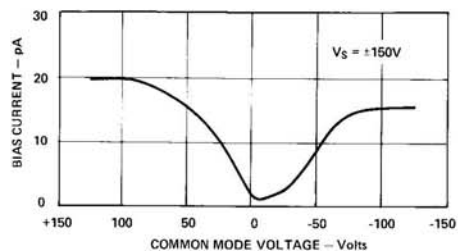

Figure 7. Bias Current vs. CMV for Model 171K

APPLICATIONS

There are many moderate-to-high voltage applications for which the model 171 FET-input op amp is useful. Typical classes of applications include:

1. Retrofit and auxiliary applications in existing analog computing systems utilizing a standard $\pm 100\text{V}$ signal-voltage range.
2. Use as low-noise buffers and input amplifiers in differential or non-inverting applications with signals derived from high-voltage sources.
3. Applications for which high output voltage is needed, e.g., wide-range precision reference sources, piezoelectric crystal drivers, etc.
4. Applications with moderate signal levels in systems subject to wide variation of supply voltage.

Model 171's excellent performance characteristics, including high supply rejection, high input impedance, low noise, tolerance of capacitive load, and protection against output short circuits, make it ideal for all these classes of application.

In addition, there is one more class that is a bit unusual. For an amplifier to be safe against short-circuits, it must not only be self-protected, it must also protect the supply that feeds it. The 171 is programmed to draw a maximum short-circuit current slightly greater than the 10mA maximum load current plus its quiescent current. Therefore, model 171 is the ideal choice for applications where a fail-safe current load that is essentially independent of supply voltage is needed.

APPLICATIONS – PROGRAMMABLE REFERENCE VOLTAGE SOURCE

The operating specifications of the model 171 make it ideally suited for use as a low-cost, high voltage reference power supply. When coupled with an appropriate D/A converter, the 171 can also function as a 12 bit programmable voltage source. Such a network, utilizing Analog Devices DAC12QZ converter, is shown in Figure 8. This system offers the versatility of binary or BCD coding and unipolar or bipolar output. Programmable levels of $\pm 50\text{V}$ or $\pm 100\text{V}$ are available by setting the output level on the D/A converter. The model 171 supply voltages can also be varied depending on the desired reference output levels. Gain control and offset control can be used, as shown in Figure 8. This type of reference supply network can be used in such applications as generation of calibration voltages (circuit or instrument testing) and low current control signal levels. Trim resistors are used in this circuit to precisely adjust the full scale and zero levels of the reference output.

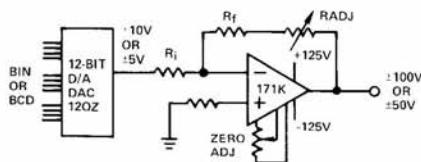

Figure 8. Programmable Power Supply

An expanded application for model 171 in a programmable voltage source for a mass spectrometer is shown in Figure 9.

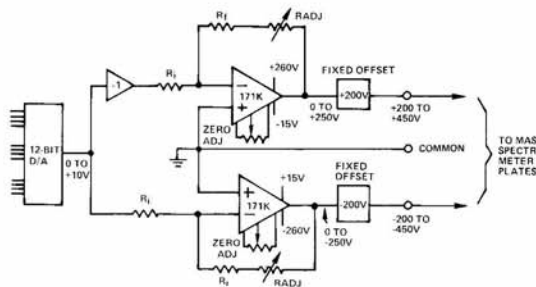

Figure 9. Programmable Mass Spectrometer Voltage Source

NONLINEAR CIRCUITS HANDBOOK

In addition to its linear devices, Analog Devices also offers a comprehensive line of nonlinear function modules (multipliers, dividers, RMS to DC converters, etc.). These function modules provide essential building blocks in systems that process information in industrial applications. In order to further the understanding of function modules, Analog Devices has issued the Nonlinear Circuits Handbook. This handbook is an invaluable source of information on principles, circuitry, performance specifications, testing and application of the class of devices used in nonlinear applications. The handbook helps identify design situations for which nonlinear devices will offer the best solution and provides the fundamentals and guidelines necessary for the proper selection and use of function modules. The Nonlinear Circuits Handbook is available from Analog Devices for \$5.95.

OTHER AMPLIFIERS

- High Performance FET – model 52: low noise ($1.5\mu\text{V}$ p-p, 1Hz BW), low drift ($1\mu\text{V}/^\circ\text{C}$, 52K) low bias (3pA max), CMRR = 80dB min
- Wideband – model 48: 15MHz (unity gain), low noise $2\mu\text{V}$ p-p, 1Hz BW, 300ns settling, $15\mu\text{V}/^\circ\text{C}$ drift (max)
- Wideband, Fast Settling – model 50: 70MHz (unity gain), 100mA output, $15\mu\text{V}/^\circ\text{C}$ drift (max, 50K)
- Chopper Stabilized – model 261: guaranteed low noise ($1\mu\text{V}$ p-p max, 1Hz BW), $\pm 0.1\mu\text{V}/^\circ\text{C}$ drift (max, 261K)
- Economy Electrometer – model 42: lowest bias (75 fA, 42K)
- High Output Voltage – model 50: 100mA output, wideband (10MHz, f_p), 80ns settling