

**LED NUMERIC DISPLAY, 1 DIGIT**
**BL-S32X-11**
**■ Features:**

- 8.0mm (0.32") Single digit numeric display series
- Low current operation.
- Excellent character appearance.
- Easy mounting on P.C. Boards or sockets.
- I.C. Compatible.
- ROHS Compliance.

**Super Bright**
**Electrical-optical characteristics: (Ta=25°C) (Test Condition: IF=20mA)**

Part No		Chip			VF Unit:V		Iv TYP.(mcd)
Common Cathode	Common Anode	Emitted Color	Material	$\lambda_p$ (nm)	Typ	Max	
BL-S32A-11S-XX	BL-S32B-11S-XX	Hi Red	GaAlAs/GaAs,SH	660	1.85	2.20	6
BL-S32A-11D-XX	BL-S32B-11D-XX	Super Red	GaAlAs/GaAs,DH	660	1.85	2.20	12
BL-S32A-11UR-XX	BL-S32B-11UR-XX	Ultra Red	GaAlAs/GaAs,DDH	660	1.85	2.20	14
BL-S32A-11E-XX	BL-S32B-11E-XX	Orange	GaAsP/GaP	635	2.10	2.50	10
BL-S32A-11Y-XX	BL-S32B-11Y-XX	Yellow	GaAsP/GaP	585	2.10	2.50	10
BL-S32A-11G-XX	BL-S32B-11G-XX	Green	GaP/GaP	570	2.20	2.50	10

**Ultra Bright**
**Electrical-optical characteristics: (Ta=25°C) (Test Condition: IF=20mA)**

Part No		Chip			VF Unit:V		Iv TYP.(mcd)
Common Cathode	Common Anode	Emitted Color	Material	$\lambda_p$ (nm)	Typ	Max	
BL-S32A-11UHR-XX	BL-S32B-11UHR-XX	Ultra Red	AlGaInP	645	2.10	2.50	14
BL-S32A-11UE-XX	BL-S32B-11UE-XX	Ultra Orange	AlGaInP	630	2.10	2.50	12
BL-S32A-11YO-XX	BL-S32B-11YO-XX	Ultra Amber	AlGaInP	619	2.10	2.50	12
BL-S32A-11UY-XX	BL-S32B-11UY-XX	Ultra Yellow	AlGaInP	590	2.10	2.50	12
BL-S32A-11UG-XX	BL-S32B-11UG-XX	Ultra Green	AlGaInP	574	2.20	2.50	18
BL-S32A-11PG-XX	BL-S32B-11PG-XX	Ultra Pure Green	InGaN	525	3.80	4.50	22
BL-S32A-11B-XX	BL-S32B-11B-XX	Ultra Blue	InGaN	470	2.70	4.20	25
BL-S32A-11W-XX	BL-S32B-11W-XX	Ultra White	InGaN	/	2.70	4.20	30

**■ -XX: Surface / Lens color:**

Number	0	1	2	3	4	5
Ref Surface Color	White	Black	Gray	Red	Green	
Epoxy Color	Water clear	White diffused	Red Diffused	Green Diffused	Yellow Diffused	

**LED NUMERIC DISPLAY, 1 DIGIT**
**BL-S32X-11**
**Absolute maximum ratings (Ta=25°C)**

Parameter	S	D	UR	E	Y	G	Unit
Forward Current $I_F$	25	25	25	25	25	30	mA
Power Dissipation $P_d$	60	60	60	60	60	65	mW
Reverse Voltage $V_R$	5	5	5	5	5	5	V
Peak Forward Current $I_{PF}$ (Duty 1/10 @1KHZ)	150	150	150	150	150	150	mA
Operation Temperature $T_{OPR}$	-40 to +80						°C
Storage Temperature $T_{STG}$	-40 to +85						°C
Lead Soldering Temperature $T_{SOL}$	Max.260±5°C for 3 sec Max. (1.6mm from the base of the epoxy bulb)						°C

**■ Absolute maximum ratings (Ta=25°C)**

Parameter	UHR	UE	YO	UY	UG	PG	UB	UW	Unit
Forward Current $I_F$	30	30	30	30	30	30	30	30	mA
Power Dissipation $P_d$	75	65	65	65	75	110	120	120	mW
Reverse Voltage $V_R$	5	5	5	5	5	5	5	5	V
Peak Forward Current $I_{PF}$ (Duty 1/10 @1KHZ)	150	150	150	150	150	150	100	100	mA
Operation Temperature $T_{OPR}$	-40 to +80								°C
Storage Temperature $T_{STG}$	-40 to +85								°C
Lead Soldering Temperature $T_{SOL}$	Max.260±5°C for 3 sec Max. (1.6mm from the base of the epoxy bulb)								°C

LED NUMERIC DISPLAY, 1 DIGIT

BL-S32X-11

■ Package configuration & Internal circuit diagram

BL-S32X-11 Series

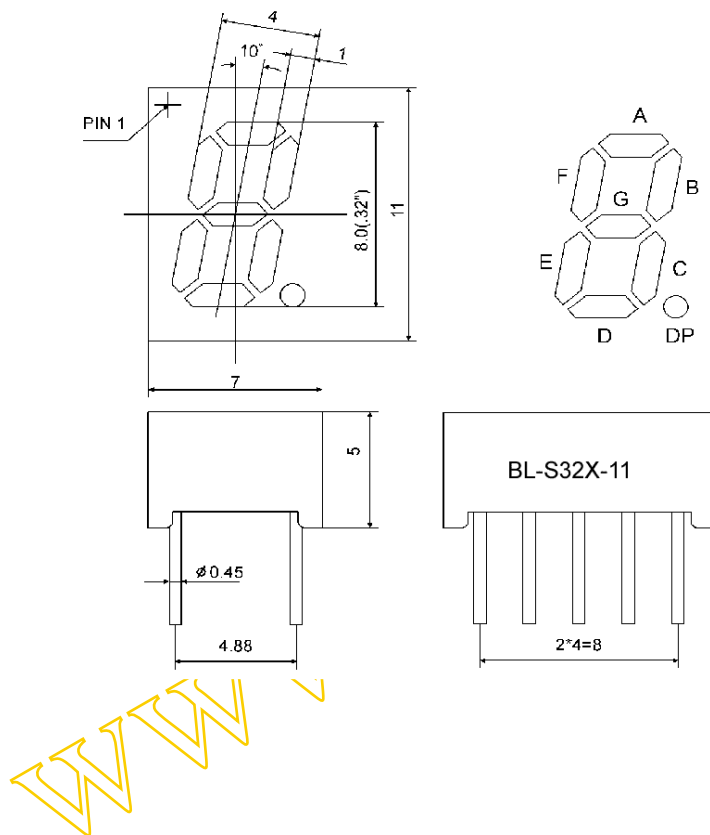

BL-S32A-11

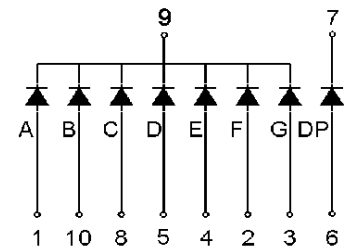

BL-S32B-11

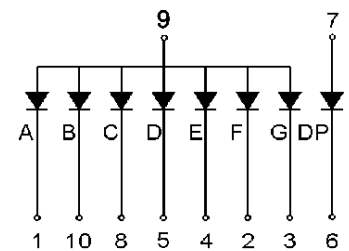

Notes:

1. All dimensions are in millimeters (inches)
2. Tolerance is  $\pm 0.25(0.01)$  unless otherwise noted.
3. Specifications are subject to change without notice.

## LED NUMERIC DISPLAY, 1 DIGIT

BL-S32X-11

### Typical electrical-optical characteristics curves:



- |   |                                      |
|---|--------------------------------------|
| (1) - GaAsP/GaAs 655nm/Red                | (9) - GaAlAs 880nm                   |
| (2) - GaP 570nm/Yellow Green              | (10) - GaAs/GaAs & GaAlAs/GaAs 940nm |
| (3) - GaAsP/GaP 585nm/Yellow              | (A) - GaN/SiC 430nm/Blue             |
| (4) - GaAsP/GaP 635nm/Orange & Hi-Eff Red | (B) - InGaN/SiC 470nm/Blue           |
| (5) - GaP 700nm/Bright Red                | (C) - InGaN/SiC 505nm/Ultra Green    |
| (6) - GaAlAs/GaAs 660nm/Super Red         | (D) - InGaN/SiC 525nm/Ultra Green    |
| (8) - GaAsP/GaP 610nm/Super Red           |                                      |

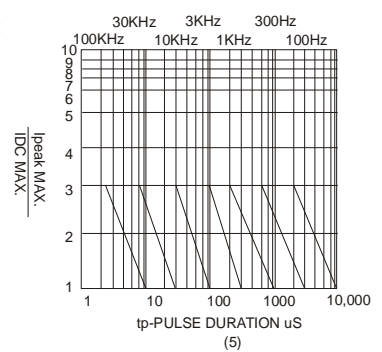
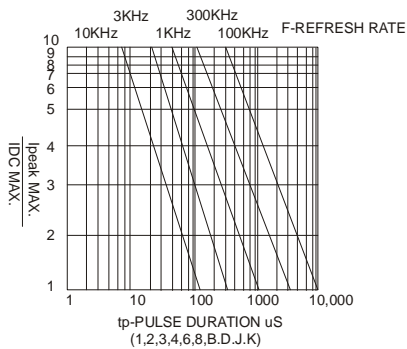
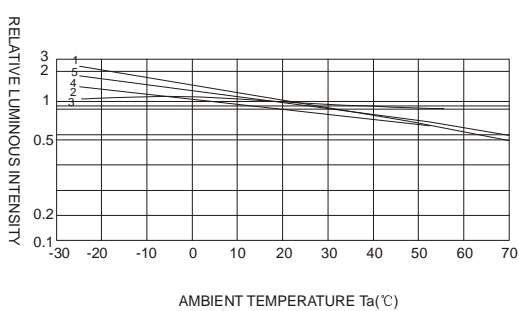
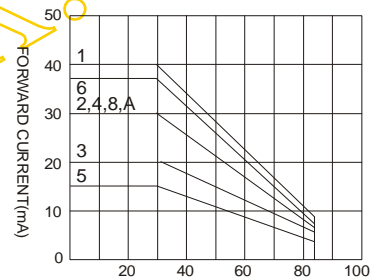
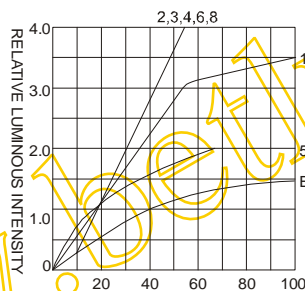

NOTE:25°C free air temperature unless otherwise specified