

# SBS® Connectors

Up to 110 amps



SBS® 75G



SBS® 50



SBS® 75X

The patented SBS® connector family is designed to provide high power in a compact ergonomic housing with protection against accidental contact with live circuits. This is of particular importance in applications where DC voltages exceed 30 volts and can be health threatening.

Wire-to-wire and wire-to-board configurations both provide power contacts rated up to 110 amps. The SBS® 75X offers up to 4 mate-last break-first auxiliary power / signal contacts rated up to 20 amps. The SBS® 75G features a third first-mate last-break ground or power contact. All contact positions are rated for circuit interruption (hot plugging).

- **Touch Safe Interface**

*Can safely be used in through panel applications  
Minimizes potential contact with live circuits per IEC 60950*

- **Wire-to-Wire and Wire-to-Board Configurations**

*Allows one connector to meet multiple needs*

- **Ground or Auxiliary Positions Integrated into the One Piece Housing**

*Meets all connection requirements in one compact connector housing*

SBS® 50 & 75

## SBS® ORDERING INFORMATION

### SBS® 50 Standard Housings

Polycarbonate housings feature 2 positions all finger proof. Genderless design mates with itself. Mechanical keys are color coded.

Description	Part Numbers	
Minimum Quantity	500	50
Red	SBS50RED-BK	SBS50RED
Gray	SBS50GRA-BK	SBS50GRA
Blue	SBS50BLU-BK	SBS50BLU
Black	SBS50BLK-BK	SBS50BLK
Brown	SBS50BRN-BK	SBS50BRN
White	SBS50WHT-BK	SBS50WHT
Green	SBS50GRN-BK	SBS50GRN

### SBS® 50 Chemical Resistant (CR) Housings

Same features as the standard housings, but molded out of a chemical resistant PBT / PC blend. Suitable for use to -40°C.

Description	Part Numbers	
Minimum Quantity	500	50
Gray	PSBS50GRA-BK	PSBS50GRA
Blue	PSBS50BLU-BK	PSBS50BLU
Green	PSBS50GRN-BK	PSBS50GRN
Black	PSBS50BLK-BK	PSBS50BLK
Red	PSBS50RED-BK	PSBS50RED
Brown	PSBS50BRN-BK	PSBS50BRN
White	PSBS50WHT-BK	PSBS50WHT

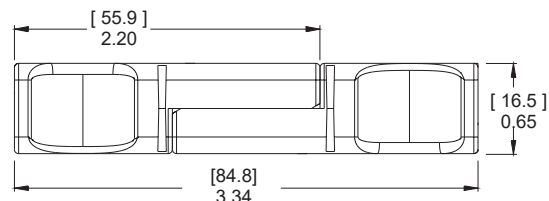
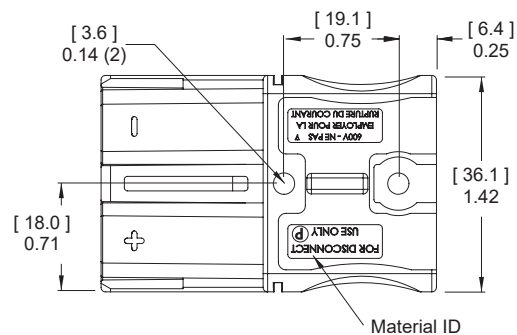

P = Chemical Resistant

### SBS® 75X Standard Housings

Polycarbonate housings feature 4 auxiliary and 2 primary positions all finger proof. Genderless design mates with itself, or the PCB connector. Mechanical keys are color coded. Inquire with Customer Service about other color offerings.

Description	Part Numbers	
Minimum Quantity	250	50
Black	SBS75XBLK-BK	SBS75XBLK
Brown	SBS75XBRN-BK	SBS75XBRN
Gray	SBS75XGRA-BK	SBS75XGRA
Blue	SBS75XBLU-BK	SBS75XBLU
Green	SBS75XGRN-BK	SBS75XGRN
White	SBS75XWHT-BK	SBS75XWHT

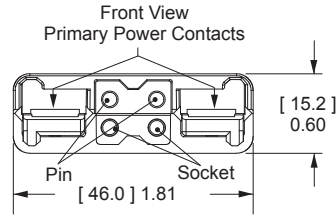

### SBS® 75X Chemical Resistant (CR) Housings

Same features as the standard housings, but molded out of a chemical resistant PBT/ PC blend. Suitable for use to -40°C. Inquire with Customer Service about other color offerings.

Description	Part Numbers	
Minimum Quantity	250	50
Green	PSBS75XGRN-BK	PSBS75XGRN
Black	PSBS75XBLK-BK	PSBS75XBLK
Gray	PSBS75XGRA-BK	PSBS75XGRA
Blue	PSBS75XBLU-BK	PSBS75XBLU
White	PSBS75XWHT-BK	PSBS75XWHT
Brown	PSBS75XBRN-BK	PSBS75XBRN

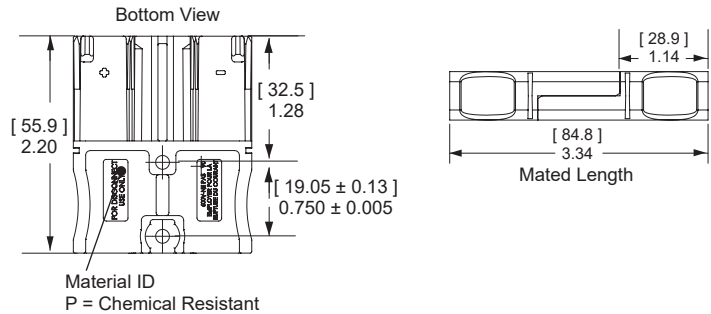

### SBS® 75X Assembled PCB Connector

Fully assembled PCB connector is designed to mate with SBS® 75X Wire connector. All positions are preloaded with contacts including standard mating length auxiliary positions. Press fit board locks help secure the connector to the PCB before and after soldering. Choose between tin or silver contacts.

Description	Part Numbers	
Minimum Quantity	250	100
Black - Tin Contact	-	SBS75XPRBLK-BK
Black - Silver Contact	SBS75XPRSBLK-BK	-

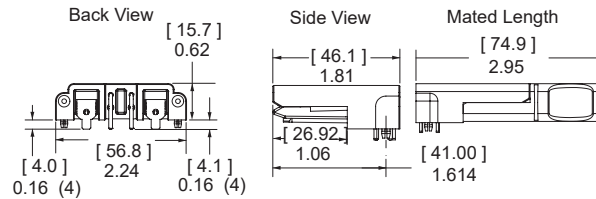

See PCB connector drawing on website for further detail.

### SBS® 75G Wire Housings

Polycarbonate housings feature three finger proof positions. The center position can be used for pre-mate power or ground. Genderless design mates with itself, or the PCB connector. Mechanical keys are color-coded. Inquire with customer service for chemical resistant housings.

Description	Part Numbers	
Minimum Quantity	250	50
Blue	SBS75GBLU-BK	SBS75GBLU
Black	SBS75GBLK-BK	SBS75GBLK
Brown	SBS75GBRN-BK	SBS75GBRN
White	SBS75GWHT-BK	SBS75GWHT

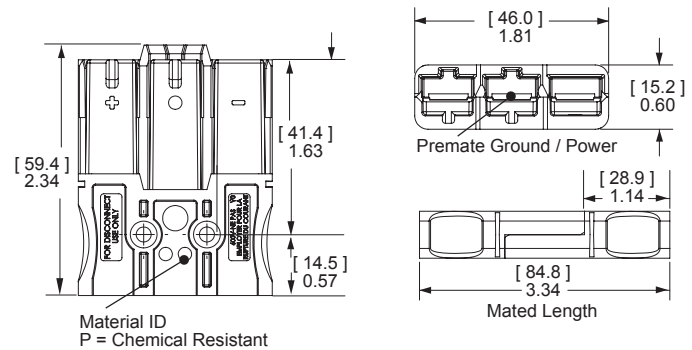

### SBS® 75G Assembled PCB Connector

Fully assembled PCB connector is designed to mate with SBS® 75G Wire connector. Has press fit board locks to help secure the connector to the PCB before and after soldering.

Description	Part Number
Minimum Quantity	100
Black	SBS75GPRBLK-BK

See PCB connector drawing on website for further detail.

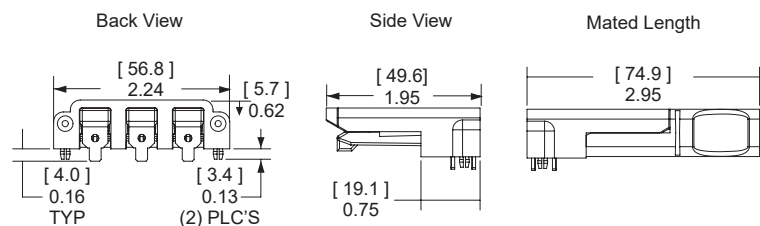

### SBS® Silver Plated Primary Power Wire Contacts

Use two silver plated contacts per housing for the best electrical performance and durability up to 10,000 mating cycles. Standard contacts are for use in all primary power positions for SBS® 50, 75X, & 75G wire housings. See reducing bushings in accessory section for smaller wires.

Type	AWG	mm <sup>2</sup>	Loose Piece Part Numbers		Dimensions - A -			
			inches	mm	inches	mm		
<b>Minimum Quantity</b>					1,000	100		
Standard	6	16	1339G2-BK	1339G2 *	0.22	5.60		
Standard	8	10	1339G5-BK	1339G5 *	0.19	4.70		
Standard	12 to 10	2.5 to 6	1339G3-BK	1339G3 *	0.14	3.50		

\* Are sold as pairs. 2 contacts ship for every 1 ordered.

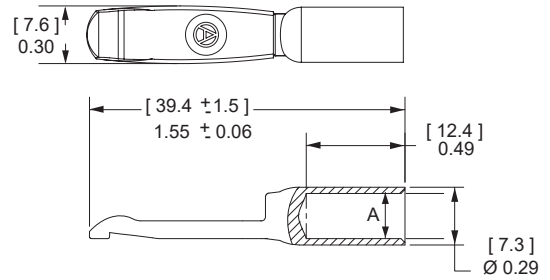

### SBS® 75G Silver Plated Pre-Mate Wire Contacts

Pre-Mate contacts used for power or ground are for the center Pre-Mate position on the SBS®75G wire housings. See reducing bushings in accessory section for smaller wires.

Type	AWG	mm <sup>2</sup>	Loose Piece Part Numbers		Dimensions - A -			
			inches	mm	inches	mm		
<b>Minimum Quantity</b>					500	50		
Pre-Mate	6	16	1340G1-BK	1340G1	0.22	5.60		
Pre-Mate	8	10	1340G2-BK	1340G2	0.19	4.70		
Pre-Mate	12 to 10	2.5 to 6	1340G3-BK	1340G3	0.14	3.50		

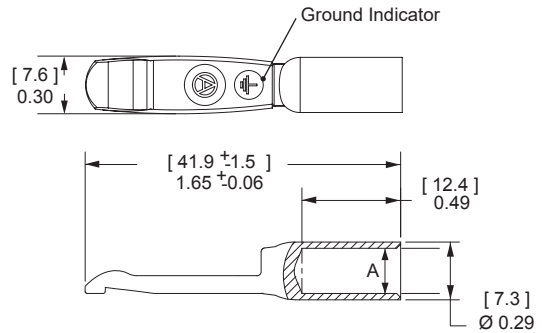

### Pin Contacts for SBS® 75X Auxiliary

Gold plated contacts are available in 3 lengths to allow sequencing of circuits.

Description	AWG	mm <sup>2</sup>	Part Numbers	
<b>Minimum Quantity</b>				
Standard Length 7.7 mm	12	2.5	PM16P12S30	PM16P12S30-50
	16 to 14	1.0 to 1.5	PM16P1416S30	PM16P1416S30-50
	20 to 16	0.75 to 1.0	PM16P1620S30	PM16P1620S30-50
	24 to 20	0.50 to 0.75	PM16P2024S30	PM16P2024S30-50
Pre-Mate 9.3 mm	12	2.5	PM16P12A30	-
	16 to 14	1.0 to 1.5	PM16P1416A30	-
	20 to 16	0.75 to 1.0	PM16P1620A30	-
	24 to 20	0.50 to 0.75	PM16P2024A30	-
Post-Mate 6.4 mm	12	2.5	PM16P12C30	-
	16 to 14	1.0 to 1.5	PM16P1416C30	-
	20 to 16	0.75 to 1.0	PM16P1620C30	-
	24 to 20	0.50 to 0.75	PM16P2024C30	-

Auxiliary Pin Contact Lengths	- L -		- L1 -	
	in.	mm	in.	mm
<b>Standard Length 7.7 mm</b>	0.77	19.6	0.30	7.7
<b>Pre-Mate 9.3 mm</b>	0.83	21.2	0.37	9.3
<b>Post-Mate 6.4 mm</b>	0.72	18.3	0.25	6.4

See drawings on website for further details

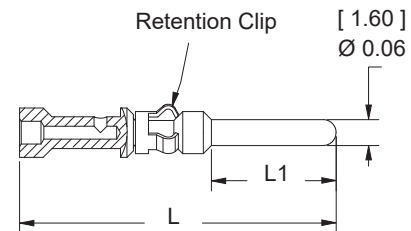

### Socket Contacts for SBS® 75X Auxiliary

Selectively gold plated contacts offer low resistance and durability up to 10,000 mating cycles.

Description	AWG	mm <sup>2</sup>	Part Numbers		Auxiliary Socket Contacts Crimp Barrel ID			
			in.	mm.	Wire Gauge	in.	mm.	
<b>Minimum Quantity</b>								
Socket Contact	12	2.5	PM16S12S32	PM16S12S32-50	24 to 20	0.04	1.1	
	16 to 14	1.0 to 1.5	PM16S1416S32	PM16S1416S32-50	20 to 16	0.07	1.7	
	20 to 16	0.75 to 1.0	PM16S1620S32	PM16S1620S32-50	16 to 14	0.08	2.1	
	24 to 20	0.50 to 0.75	PM16S2024S32	PM16S2024S32-50	12	0.10	2.6	

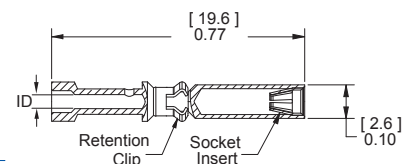

See drawings on website for further details

# SBS® CONNECTOR TEMPERATURE CHARTS - Temperature rise charts are based on a 25°C ambient temperature.

Current - Temperature Derating per IEC 60512-5-2 Test 5B

SBS® 50 & 75

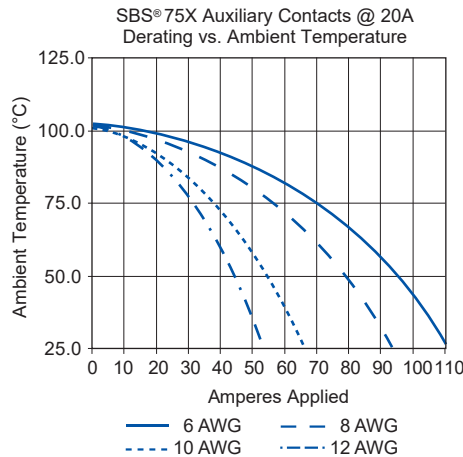
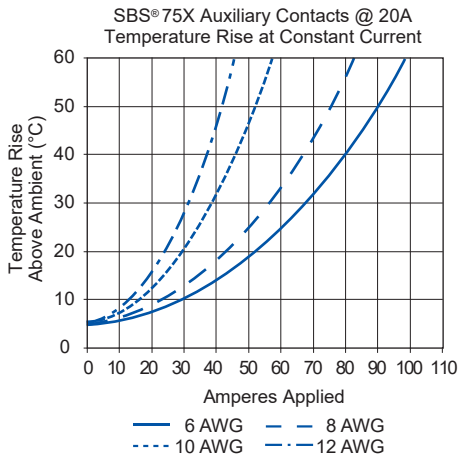
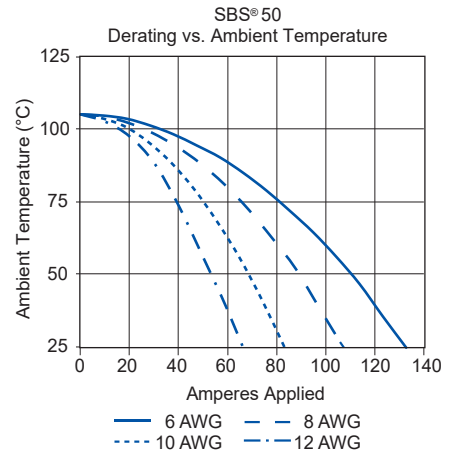
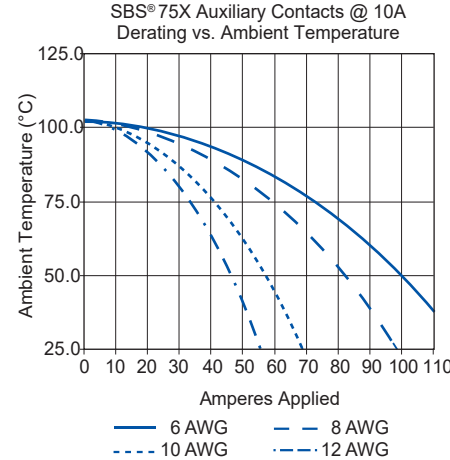
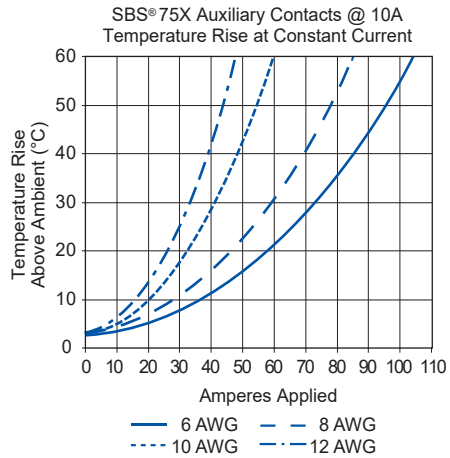
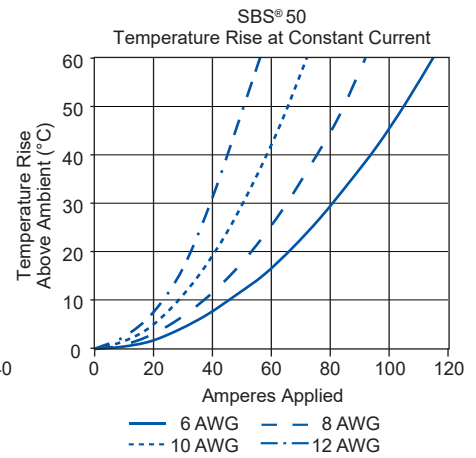
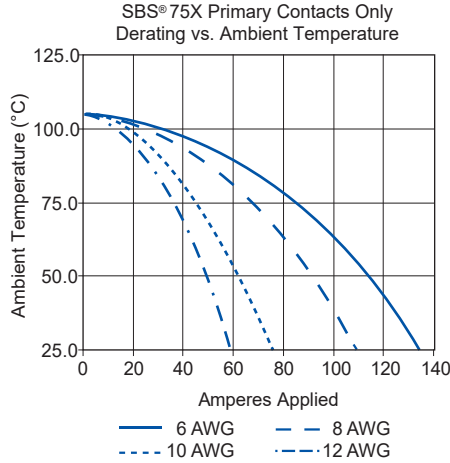
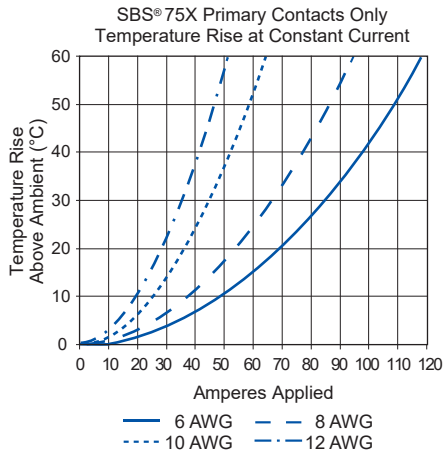

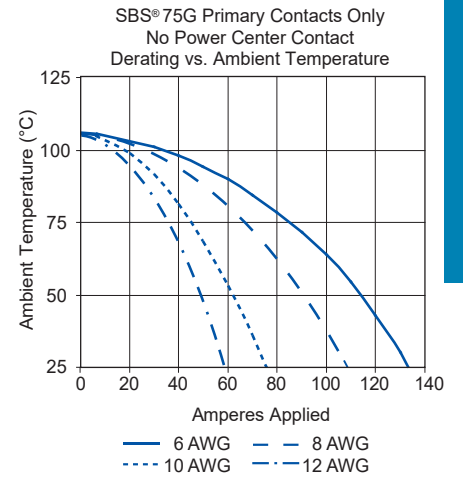
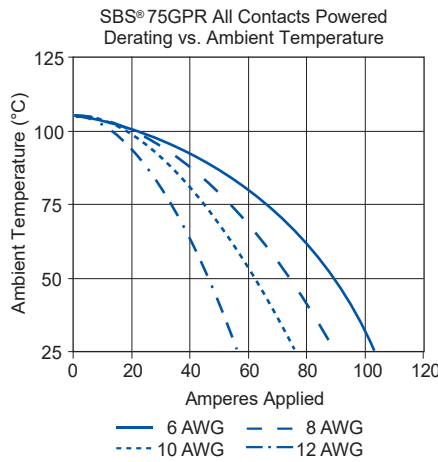
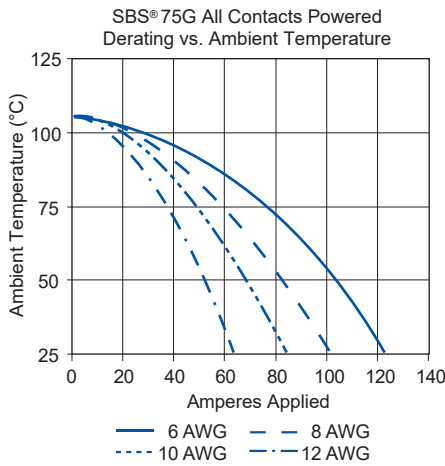
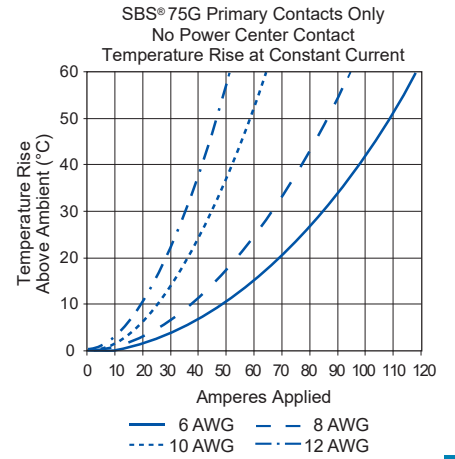
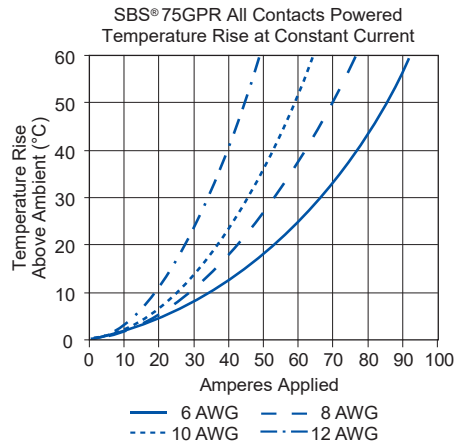
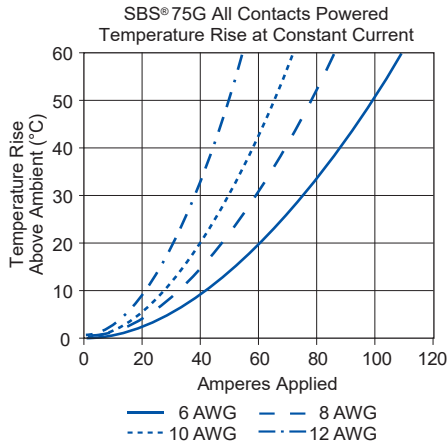

# SBS® CONNECTOR SPECIFICATIONS

## ELECTRICAL

Current Rating Amperes <sup>1</sup>	UL 1977	CSA / TUV	EN1175 : 1998 <sup>†</sup> A1
Primary Power (6 AWG)	110	75	80
Auxiliary (12 AWG)	20	10	20
<b>Voltage Rating AC/DC</b>			
UL 1977	600	600	96
<b>Dielectric Withstanding Voltage</b>			
Volts AC	2,200		
<b>Avg. Mated Contact Resistance Milliohms <sup>1</sup></b>			
Power & Ground: 1 1/4" of 6 AWG wire	0.200		
Auxiliary: Wire & PCB	3.000		
<b>Hot Plug Current Rating Amperes - 250 cycles at 120V DC    5 Cycles at 96V DC</b>			
Wire & PCB Power	50A		
Wire & PCB Auxiliary	5A	200A	
<b>Ground Short Time Current Test - SBS® 75G Wire &amp; PCB</b>			
1530 Amps, (6 AWG) Wire	6 Seconds		

## MATERIALS

<b>Housing</b>	
Standard Plastic Resin	Polycarbonate
Chem. Resistant Resin	Polycarbonate / PBT Blend
Contact Retention Spring	Stainless Steel
<b>Housing Flammability Rating</b>	
UL94	V-0
Glow Wire - SBS® 50	825°C (GWFI) / 800°C (GWIT)
- SBS® 75G	960°C (GWFI) / 800°C (GWIT)
- SBS® 75X	960°C (GWFI) / 800°C (GWIT)
<b>Wire Power &amp; Ground Contact</b>	
	Silver Plated Copper Alloy
<b>PCB Power &amp; Ground Contact</b>	
	Tin Plated Copper Alloy
<b>SBS® 75X Auxiliary Contacts</b>	
Pin	Copper Alloy, Au Over Ni
Socket	BeCu, Au over Ni
Socket Body	Copper Alloy, Sn Bright Over Ni
Retention Clip	Stainless Steel
<b>PCB Press Fit Retainers</b>	
	Brass - Tin Plated
<b>Contact Termination Methods</b>	
Crimp <sup>3</sup>	Wire Contacts
Hand Solder	Wire and PCB Contacts
Solder Dip	PCB Contacts
Wave Solder	PCB Contacts

## MECHANICAL

Wire Size Range	AWG	mm <sup>2</sup>	
Power Contacts (with bushings)	16 to 6	1.3 to 13.3	
Auxiliary Contacts	24 to 12	0.25 to 3.3	
Max. Wire Insulation Diameter	in.	mm	
SBS® 75G Power & Ground	0.380	9.652	
SBS® 50 & SBS® 75X Power Contacts	0.410	10.414	
SBS® 75X Auxiliary Contacts	0.140	3.600	
Operating Temperature <sup>2</sup>	°F	°C	
Standard	-4° to 221°	-20° to 105°	
Chemical Resistant	-40° to 221°	-40° to 105°	
Mating Cycles No Load by Plating	Silver (Ag)	Tin (Sn)	Gold (Au)
Power & Ground Contacts Wire	10,000		
Power & Ground Contacts PCB		1,500	
Auxiliary Contacts			10,000
Avg. Mating / Unmating Force	Lbf.	N	
SBS® 75X and SBS® 75G Wire-to-Wire	16	70	
SBS® 50 Wire-to-Wire	8	36	
SBS® 75X and SBS® 75G Wire-to-PCB	8	36	
Min. Contact / Spring Retention Force	Lbf.	N	
Power, Standard Housing	50	222	
Power, Chemical Resistant Housing	30	133	
Auxiliary Standard Housing	15	67	
Auxiliary Chemical Resistant Housing	10	44	
PCB Specifications			
Mounting Style	Plated Through Hole		
Max PCB Thickness - in. (mm)	0.093 (2.4)		
Recommended Traces Power & Ground	6 AWG Cross Section		
Recommended Traces Auxiliary	12 AWG Cross Section		
Min. Creepage / Clearance Distance PCB	in.	mm	
Power to Auxiliary Creepage SBS® 75X	0.41	10.4	
Power to Auxiliary Clearance SBS® 75X	0.24	6.1	
Power to Ground Creepage SBS® 75G	0.35	8.9	
Power to Ground Clearance SBS® 75G	0.26	6.7	
Auxiliary Creepage SBS® 75X	0.12	3.0	
Auxiliary Clearance SBS® 75X	0.12	3.0	



- Auxiliary contacts are available for SBS® 75X only.
- SBS® 75X and SBS® 75G PCB connectors are designed to mate only with the wire connector of the same series.

NOTE 1: See IEC 60664-1 for working voltage.

NOTE 2: Amp ratings are stated per position and based on all positions being fully loaded.

1 - Based on: 105°C rated or better cable of the largest size. Properly calibrated APP® recommended tooling, and a 25°C ambient temperature.

UL rating not to exceed the maximum operating temperature. CSA rating below a 30°C temperature rise. EN1175-1 : 1998 + A1 is tested solely to annex A.

To be installed according to the manufacturers instructions.

2 - Limited by the thermal properties of the connector plastic housing.

3 - Use APP® recommended tooling only. Alternate tools may adversely affect the performance of our connectors along with UL and CSA recognition.

## IEC INFORMATION

Connector Series	Configurations	Creepage / Clearance per IEC 60950-1	Material Group
SBS® 75G	Unmated	3.33 mm	IIIa
	Mated	4.64 mm	

Connector Series	Configurations	Creepage / Clearance per IEC 60950-1	Material Group
SBS® 75X	Unmated	3.33 mm	IIIa
	Mated	4.64 mm	

Connector Series	Configurations	Creepage / Clearance per IEC 60950-1	Material Group
SBS® 50	Unmated	3.85 mm	IIIa
	Mated	4.64 mm	

PROTECTION	
<b>Touch Safety with Wire Contacts &amp; PCB Mating Interface</b>	
IEC 60950	Pass
IEC 60529	IP20

ATTRIBUTES	SBS® 50
<b>AMP Rating AC/DC - Power Only</b>	6 AWG - 75A, 8 AWG 65A - 10 AWG - 45A, 12 AWG - 35A
<b>Voltage Rating AC/DC (Steady State)</b>	600 AC / DC (Operational)
Auxiliary Contacts	NA
<b>Breaking Capacity - AMP Rating / Cycles - Power Contacts</b>	6 AWG - 50A, 120 VDC / 250 Cycles
<b>Breaking Capacity - Auxiliary Contacts</b>	NA
<b>Voltage Rating (Breaking Capacity)</b>	120 VDC
<b>Finger Safety - Mated only</b>	IEC 60529 - IP20
<b>Wire Size Tested</b>	Power 12, 10, 8, 6 AWG
<b>Contact Series Tested</b>	1339G2, 1339G3, 1339G5
Auxiliary contacts	NA
<b>Climatic Testing (Cold, Heat &amp; MFG)</b>	IEC 60512 Test - 11j, 11i & 11g
<b>Cycle Life</b>	IEC 60512 Test 9a - 5,000 Cycles
<b>Mechanical Strength Impact</b>	IEC 60512-5 @ 29.5 Inches - Dropped 8 Times
<b>Temperature Range</b>	-20°C to 105°C -4°F to 221°F

ATTRIBUTES	SBS® 75X
<b>AMP Rating AC/DC - Power only</b>	6 AWG - 75A, 8 AWG 65A - 10 AWG - 45A, 12 AWG - 35A
<b>Power Contacts and Auxiliary Contacts (Auxiliary contacts at 15A)</b>	6 AWG - 75A, 8 AWG 60A - 10 AWG - 35A, 12 AWG - 30A
Auxiliary Contacts	12 AWG - 15A
<b>Voltage Rating AC/DC (Steady State)</b>	600V AC/DC (Operational)
Auxiliary Contacts	12 AWG - 15A
<b>Breaking Capacity - AMP Rating / Cycles - Power Contacts</b>	6 AWG - 50A, 120 VDC / 250 Cycles
<b>Breaking Capacity - Auxiliary Contacts</b>	12 AWG - 5A, 120 VDC / 250 Cycles
<b>Voltage Rating (Breaking Capacity)</b>	120 VDC
<b>Finger Safety - Mated Only</b>	IEC 60529 - IP20
<b>Wire Size Tested</b>	Power 12 AWG, 10 AWG, 8 AWG, 6AWG / Signal 12 AWG
<b>Contact Series Tested</b>	Power 1339G2, 1339G3, 1339G5
Auxiliary Contacts	PM16P12S30, PM16S12S32
<b>Climatic Testing (Cold, Heat &amp; MFG)</b>	IEC 60512 Test - 11j, 11i & 11g,
<b>Cycle Life</b>	IEC 60512 Test 9a - 5,000 Cycles
<b>Mechanical Strength Impact</b>	IEC 60512-5 @ 29.5 Inches - Dropped 8 Times
<b>Temperature Range</b>	-20°C to 105°C -4°F to 221°F



Attributes	SBS® 75G
<b>AMP Rating AC/DC - Power Only</b>	110
<b>Power Contacts and Auxiliary contacts ( Auxiliary contacts at 15A)</b>	NA
Auxiliary Contacts	NA
<b>Voltage Rating AC/DC (Steady State)</b>	600V AC/DC (Operational)
Auxiliary Contacts	NA
<b>Breaking Capacity - AMP Rating / Cycles - Power Contacts</b>	6 AWG - 50A, 120 VDC / 250 Cycles
<b>Breaking Capacity - Auxiliary Contacts</b>	NA
<b>Voltage Rating (Breaking Capacity)</b>	120 VDC
<b>Finger Safety - Mated Only</b>	IEC 60529 - IP10, IP20
<b>Wire Size Tested</b>	6 AWG
<b>Contact Series Tested</b>	Power 1339G2, 1339G3, 1339G5 / Ground 1340G1
Auxiliary Contacts	NA
<b>Climatic Testing (Cold, Heat &amp; MFG)</b>	IEC 60512 Test-11j, 11i & 11g
<b>Cycle Life</b>	IEC 60512 Test 9a - 1,500 Cycles
<b>Mechanical Strength Impact</b>	IEC 60512-5 @ 29.5 Inches- Dropped 8 Times
<b>Temperature Range</b>	-20°C to 105°C -4°F to 221°F

Attributes	SBS® 75G and GPR (PCB)
<b>AMP Rating AC/DC - Power Only</b>	110
<b>Power Contacts and Auxiliary contacts ( Auxiliary contacts at 15A)</b>	NA
Auxiliary Contacts	NA
<b>Voltage Rating AC/DC (Steady State)</b>	600V AC / DC (Operational)
Auxiliary Contacts	NA
<b>Breaking Capacity - AMP Rating / Cycles - Power Contacts</b>	6 AWG - 50A,120 VDC / 250 Cycles
<b>Breaking Capacity - Auxiliary Contacts</b>	NA
<b>Voltage Rating (Breaking Capacity)</b>	120 VDC
<b>Finger Safety - Mated Only</b>	IEC 60529 - IP20
<b>Wire Size Tested</b>	6 AWG
<b>Contact Series Tested</b>	Power B02075P1 / Ground B02114P1
Auxiliary Contacts	NA
<b>Climatic Testing (Cold, Heat &amp; MFG)</b>	IEC 60512 Test - 11j, 11i & 11g
<b>Cycle Life</b>	IEC 60512 Test 9a - 1,500 Cycles
<b>Mechanical Strength Impact</b>	NA
<b>Temperature Range</b>	-20°C to 105°C -4°F to 221°F



# SBS® ACCESSORIES

## Mounting Clamp for SBS® 50 \*

Mounting clamps can be used for fastening a SBS® 50 series housings to a panel. Fastening hardware not included.

Description	Part Number
Minimum Quantity	20 sets of 2
Panel Mount Bracket for SBS® 50	1466G1

\* Torque value 5 (in - lbs) / 0.56 (Nm)

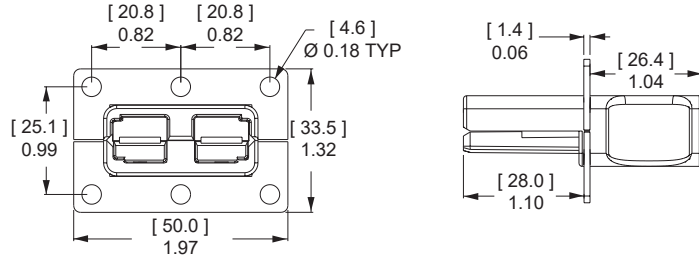

## T-Handles for SBS® 50 and SBS® 75X \*

The "T" handles make mating and unmating the connector easier. The non-conductive polycarbonate or chemical resistant PBT red plastic material is strong and safe.

(2) Self tapping screws are used to secure the handle to the connector housing.

Description	Part Numbers	
Minimum Quantity	1,000	50
Red "T" Handle + Hardware Bag	-	SBS50-HDL-RED
Hardware Bag (2 Screws)	-	104G17
Red "T" Handle Only	113899P1	-
PBT SBS50 "T" Handle, Red	113899P2	-
#8 x 5/8" Screw (Order 2 Per Handle)	H1120P55	-
PBT SBS® 50 Handle, Red + Hardware	-	PSBS50-HDL-RED

\* Torque value 10 (in - lbs) / 1.13 (Nm)

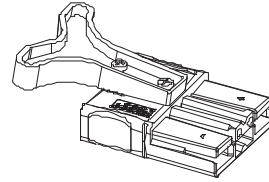

## "A" Frame Handle for SBS® 50 and SBS® 75X \*

Handle makes mating and unmating the connector easier. The non-conductive gray plastic material is strong and safe. Machine screws and locknuts included.

Description	Part Number
Minimum Quantity	200
Gray "A" Handle & Hardware	997G1

\* Torque value 12 (in - lbs) / 1.4 (Nm)

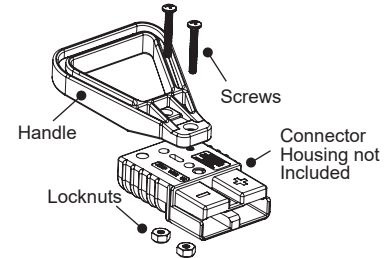

## T-Handle for SBS® 75G \*

The "T" handle makes mating and unmating the connector easier. The non-conductive red plastic material is strong and safe. (2) Machine screws and lock nuts.

Description	Part Number
Minimum Quantity	50
Red "T" Handle + Hardware Bag	SBS75GHDLRED

\* Torque value 10 (in - lbs) / 1.13 (Nm)

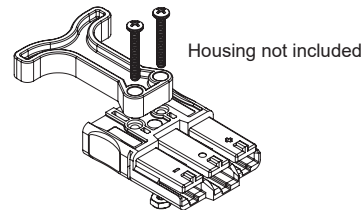

## Dust Cover SBS® 50

Prevents dust and dirt from entering the mating interface of the connector when unmated. *NOTE: Not a Hermetic Seal.*

Description	Part Numbers	
Minimum Quantity	500	50
Dust Cover with Lanyard Strap, Red	113890P1	134G1

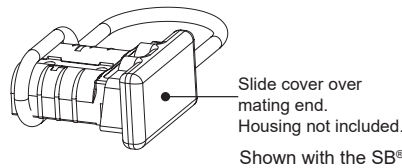

## Cable Clamps for SBS® 50 \*

Durable metal cable clamps securely hold cables to prevent accidental strain or pulls from dislodging wire or contacts from the housing. Cable clamps are recommended for solder terminated wires.

Description	Cable Size		Part Numbers	
	AWG or (Inches O.D.) *	mm <sup>2</sup> or (mm O.D.) *		
Minimum Quantity			500	50
Self Attaching for Discrete Conductor	8 to 6	10	990-BK	990
Self Attaching for Discrete Conductor	12 to 10	2.5 to 4	990G2-BK	990G2
Bolt On for Discrete Conductor	12 to 6	2.5 to 10	990G1-BK	990G1
Bolt On for Bundled Conductor	0.320 to 0.450	4.27 to 11.43	5905-BK	5905

\* Torque value 12 (in - lbs) / 1.4 (Nm) *NOTE: For assembly of clamp to housing only*

The given wire O.D. information is an estimate. Cable clamps should be evaluated for performance with the actual wire to be used.

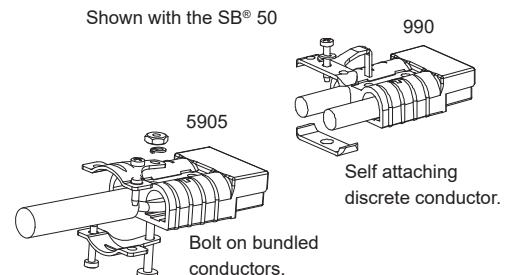

SBS® 50 & 75

### Cable Clamps for SBS® 75X with Integral Handle \*

Rugged chemical resistant PBT/ PC plastic cable clamps securely hold cables to prevent accidental strain or pulls from dislodging wire or contacts from the housing. Cable clamps are recommended for solder terminated wires.

Description	Cable Size AWG or (Inches O.D.) **	mm <sup>2</sup> or (mm O.D.) **	Part Numbers	
<b>Minimum Quantity</b>			100	25
Large Wire Clamp Kit w/ Hardware	12 to 6 (0.39 to 0.60)	4 to 10 (9.9 to 15.2)	PSBS75XCLP1-BK	PSBS75XCLP1
Small Wire Clamp Kit w/ Hardware	12 to 6 (0.34 to 0.55)	4 to 10 (8.6 to 14.0)	PSBS75XCLP2-BK	PSBS75XCLP2

\* Torque value 5 (in - lbs) / 0.56 (Nm).

\*\* The given wire O.D. information is an estimate.

Cable clamps should be evaluated for performance with the actual wire to be used.

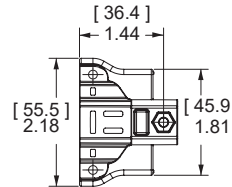
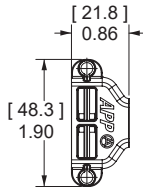

Clamp hardware requires phillips or flat blade screwdriver to assemble.

### Reducing Bushings

Use with contact part number 1339G2-BK or 1340G1-BK to allow a smaller wire to be used with the connector. Electrical capability is derated with smaller wire.

Contact Barrel Size AWG mm <sup>2</sup>	Wire Size AWG mm <sup>2</sup>	Dimensions			- ID -		- Length -	
		Part Numbers	inches	mm	inches	mm		
<b>Minimum Quantity</b>		3,000	1,000	100				
6 13.3	8 8.4	-	5912-BK	5912	0.18	4.6	0.45	11.4
6 13.3	12 to 10 3.3 to 5.3	5910-BK	-	5910	0.14	3.6	0.47	11.9
6 13.3	16 to 14 1.3 to 2.1	5913-BK	-	5913	0.09	2.3	0.47	11.9

See drawings on website for further detail

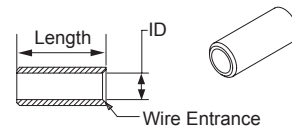

## SBS® TOOLING INFORMATION

Wire Size		Power / Ground Contacts								
AWG	mm <sup>2</sup>	Power Contact Part Number	Pneumatic Bench Tool	+	Die	+	Locator	Number of Crimps	OR	Hand Tool
6	13.3	1339G2	1387G1		1388G6		1389G9	Single		1309G4
8	8.4	1339G5			1388G7					
10 to 12	5.3 to 3.3	1339G3			1388G6					
6	13.3	1340G1			1388G7		1389G20			
8	8.4	1340G2								
10 to 12	5.3 to 3.3	1340G3								

Wire Size		SBS® 75X Auxiliary Contacts								
AWG	mm <sup>2</sup>	Auxiliary Contact Part Number	APP® Hand Tool w/ Integral Locator	OR	Mil Std. Hand Tool* M22520/1-01	OR	Pneumatic Tool*	Number of Crimps	+	Locator for: TM0001 & TP0001
12 to 24	2.5 to 0.25	All Crimp Pins	PM1000G1		TM0001		TP0001	Single		TL0001
		All Crimp Sockets								TL0002

SBS® 75X Auxiliary Contact Insertion Tool: PM1002G1

SBS® 75X Auxiliary Contact Extraction Tool: PM1003G1

SBS® 75X Auxiliary Contact Insertion Inspection Tool: PM1003GX

SBS® 75X Insertion Tool: 111038G3

\* TP0001 and TM0001 tools require locators TL0001 for Pins and TL0002 for Sockets.

NOTE: See website for the most current information.

The auxiliary contacts used with wire sizes 16 to 24 AWG cannot be properly inserted without the insertion tool. Properly installed auxiliary contact of all wire gauges cannot be removed from the housing without the extraction tool. It is highly recommended that inspection tool be used to ensure the auxiliary contacts are seated properly.

### 2021-0065 DS-SBS REV C7.1 Your Best Connection™

Anderson™ will use reasonable efforts to include accurate and up-to-date content in the data sheet. All product information contained in the data sheet including ordering information, illustrations, specifications, and dimensions, are believed to be reliable as of the date of publishing, but is subject to change without notice. Anderson™ makes no warranty or representation as to its accuracy. Content in the data sheet may contain technical inaccuracies, typographical errors and may be changed or updated without notice. Anderson™ may also make improvements and/or changes to the products and/or to the programs described in the content at any time without notice. Current sales drawings and specifications are available upon request.

©2021 Anderson Power Products, Inc. All rights reserved. APP®, A®, Anderson Power Products®, SBS® and the APP Logo are registered trademarks of Anderson Power Products, Inc. Anderson™ and Your Best Connection™ are trademarks of Anderson Power Products, Inc.

All Data Subject To Change Without Notice

www.andersonpower.com



SBS® 50 & 75