

## MAX6126

## Ultra-High-Precision, Ultra-Low-Noise, Series Voltage Reference

### General Description

The MAX6126 is an ultra-low-noise, high-precision, low-dropout voltage reference. This family of voltage references feature curvature-correction circuitry and high-stability, laser-trimmed, thin-film resistors that result in 3ppm/°C (max) temperature coefficients and an excellent ±0.02% (max) initial accuracy. The proprietary low-noise reference architecture produces a low flicker noise of 1.3μV<sub>p-p</sub> and wideband noise as low as 60nV/√Hz (2.048V output) without the increased supply current usually found in low-noise references. Improve wideband noise to 35nV/√Hz and AC power-supply rejection by adding a 0.1μF capacitor at the noise reduction pin. The MAX6126 series mode reference operates from a wide 2.7V to 12.6V supply voltage range and load-regulation specifications are guaranteed to be less than 0.025Ω for sink and source currents up to 10mA. These devices are available over the automotive temperature range of -40°C to +125°C.

The MAX6126 typically draws 380μA of supply current and is available in 2.048V, 2.500V, 2.800V, 3.000V, 3.300V, 3.600V, 4.096V, and 5.000V output voltages. The MAX6126 also feature dropout voltages as low as 200mV. Unlike conventional shunt-mode (two-terminal) references that waste supply current and require an external resistor, the MAX6126 offers supply current that is virtually independent of supply voltage and does not require an external resistor. The MAX6126 is stable with 0.1μF to 10μF of load capacitance.

The MAX6126 is available in the tiny 8-pin μMAX®, as well as 8-pin SO packages.

### Applications

- High-Resolution A/D and D/A Converters
- ATE Equipment
- High-Accuracy Reference Standard
- Precision Current Sources
- Digital Voltmeters
- High-Accuracy Industrial and Process Control

μMAX is a registered trademark of Maxim Integrated Products, Inc.

### Ordering Information

| PART           | TEMP RANGE      | PIN-PACKAGE | OUTPUT VOLTAGE (V) | MAXIMUM INITIAL ACCURACY (%) | MAXIMUM TEMPCO (-40°C to +85°C) (ppm/°C) |
|----------------|-----------------|-------------|--------------------|------------------------------|--|
| MAX6126AASA21+ | -40°C to +125°C | 8 SO        | 2.048              | 0.02                         | 3  |
| MAX6126BASA21+ | -40°C to +125°C | 8 SO        | 2.048              | 0.06                         | 5  |
| MAX6126A21+    | -40°C to +125°C | 8 μMAX      | 2.048              | 0.06                         | 3  |

+Denotes a lead(Pb)-free/RoHS-compliant package.

### Benefits and Features

- Ultra-Low 1.3μV<sub>p-p</sub> Noise (0.1Hz to 10Hz, 2.048V Output)
- Ultra-Low 3ppm/°C (max) Temperature Coefficient
- ±0.02% (max) Initial Accuracy
- Wide (V<sub>OUT</sub> + 200mV) to 12.6V Supply Voltage Range
- Low 200mV (max) Dropout Voltage
- 380μA Quiescent Supply Current
- 10mA Sink/Source-Current Capability
- Stable with C<sub>LOAD</sub> = 0.1μF to 10μF
- Low 20ppm/1000hr Long-Term Stability
- 0.025Ω (max) Load Regulation
- 20μV/V (max) Line Regulation
- Force and Sense Outputs for Remote Sensing

### Pin Configuration

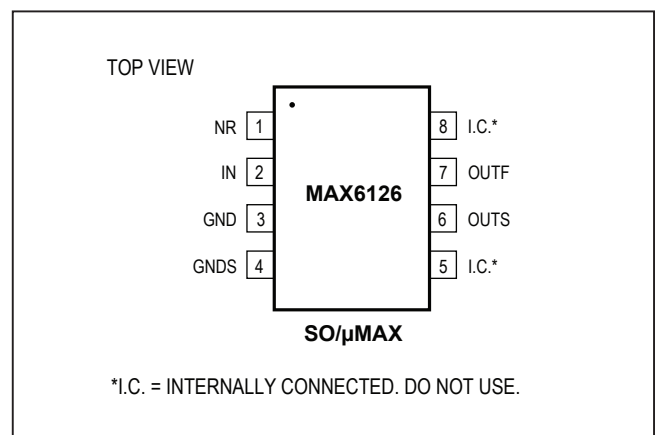

[Ordering Information](#) continued at end of data sheet.

**Absolute Maximum Ratings**

(All voltages referenced to GND)

|   |  |
|---|--|
| GNDS .....  | -0.3V to +0.3V   |
| IN .....  | -0.3V to +13V  |
| OUTF, OUTS, NR.....                                   | -0.3V to the lesser of (V <sub>IN</sub> + 0.3V) or +6V |
| Output Short Circuit to GND or IN.....                | 60s  |
| Continuous Power Dissipation (T <sub>A</sub> = +70°C) |  |
| 8-Pin μMAX (derate 4.5mW/°C above +70°C).....         | 362mW  |
| 8-Pin SO (derate 5.88mW/°C above +70°C).....          | 471mW  |

|  |                 |
|--|-----------------|
| Operating Temperature Range.....       | -40°C to +125°C |
| Junction Temperature.....              | +150°C          |
| Storage Temperature Range.....         | -65°C to +150°C |
| Lead Temperature (soldering, 10s)..... | +300°C          |
| Soldering Temperature (reflow).....    | +260°C          |

Stresses beyond those listed under "Absolute Maximum Ratings" may cause permanent damage to the device. These are stress ratings only, and functional operation of the device at these or any other conditions beyond those indicated in the operational sections of the specifications is not implied. Exposure to absolute maximum rating conditions for extended periods may affect device reliability.

**Electrical Characteristics—MAX6126\_21 (V<sub>OUT</sub> = 2.048V)**

(V<sub>IN</sub> = 5V, C<sub>LOAD</sub> = 0.1μF, I<sub>OUT</sub> = 0, T<sub>A</sub> = T<sub>MIN</sub> to T<sub>MAX</sub>, unless otherwise noted. Typical values are at T<sub>A</sub> = +25°C.)

| PARAMETER                                       | SYMBOL                               | CONDITIONS  | MIN                              | TYP   | MAX   | UNITS      |
|---|--------------------------------------|---|----------------------------------|-------|-------|------------|
| <b>OUTPUT</b>                                   |                                      |   |                                  |       |       |            |
| Output Voltage                                  | V <sub>OUT</sub>                     | T <sub>A</sub> = +25°C                                |                                  | 2.048 |       | V          |
| Output Voltage Accuracy                         |                                      | Referred to V <sub>OUT</sub> , T <sub>A</sub> = +25°C | A grade SO                       | -0.02 | +0.02 | %          |
|   |                                      |   | B grade SO                       | -0.06 | +0.06 |            |
|   |                                      |   | A grade μMAX                     | -0.06 | +0.06 |            |
|   |                                      |   | B grade μMAX                     | -0.1  | +0.1  |            |
| Output Voltage Temperature Coefficient (Note 1) | TCV <sub>OUT</sub>                   | T <sub>A</sub> = -40°C to +85°C                       | A grade SO                       | 0.5   | 3     | ppm/°C     |
|   |                                      |   | B grade SO                       | 1     | 5     |            |
|   |                                      |   | A grade μMAX                     | 1     | 3     |            |
|   |                                      |   | B grade μMAX                     | 2     | 7     |            |
|   |                                      | T <sub>A</sub> = -40°C to +125°C                      | A grade SO                       | 1     | 5     |            |
|   |                                      |   | B grade SO                       | 2     | 10    |            |
|   |                                      |   | A grade μMAX                     | 2     | 5     |            |
|   |                                      |   | B grade μMAX                     | 3     | 12    |            |
| Line Regulation                                 | ΔV <sub>OUT</sub> /ΔV <sub>IN</sub>  | 2.7V ≤ V <sub>IN</sub> ≤ 12.6V                        | T <sub>A</sub> = +25°C           | 2     | 20    | μV/V       |
|   |                                      |   | T <sub>A</sub> = -40°C to +125°C |       |       |            |
| Load Regulation                                 | ΔV <sub>OUT</sub> /ΔI <sub>OUT</sub> | Sourcing: 0 ≤ I <sub>OUT</sub> ≤ 10mA                 |                                  | 0.7   | 25    | μV/mA      |
|   |                                      | Sinking: -10mA ≤ I <sub>OUT</sub> ≤ 0                 |                                  | 1.3   | 25    |            |
| OUT Short-Circuit Current                       | I <sub>SC</sub>                      | Short to GND  |                                  | 160   |       | mA         |
|   |                                      | Short to IN   |                                  | 20    |       |            |
| Thermal Hysteresis (Note 2)                     | ΔV <sub>OUT</sub> /cycle             | SO  |                                  | 25    |       | ppm        |
|   |                                      | μMAX  |                                  | 80    |       |            |
| Long-Term Stability                             | ΔV <sub>OUT</sub> /time              | 1000hr at T <sub>A</sub> = +25°C                      | SO                               | 20    |       | ppm/1000hr |
|   |                                      |   | μMAX                             | 100   |       |            |

**Electrical Characteristics—MAX6126\_21 (V<sub>OUT</sub> = 2.048V) (continued)**(V<sub>IN</sub> = 5V, C<sub>LOAD</sub> = 0.1μF, I<sub>OUT</sub> = 0, T<sub>A</sub> = T<sub>MIN</sub> to T<sub>MAX</sub>, unless otherwise noted. Typical values are at T<sub>A</sub> = +25°C.)

| PARAMETER                       | SYMBOL            | CONDITIONS                                 | MIN                     | TYP       | MAX  | UNITS             |
|---------------------------------|-------------------|--|-------------------------|-----------|------|-------------------|
| <b>DYNAMIC CHARACTERISTICS</b>  |                   |  |                         |           |      |                   |
| Noise Voltage                   | e <sub>OUT</sub>  | f = 0.1Hz to 10Hz                          |                         | 1.3       |      | μV <sub>P-P</sub> |
|                                 |                   | f = 1kHz, C <sub>NR</sub> = 0              |                         | 60        |      | nV/√Hz            |
|                                 |                   | f = 1kHz, C <sub>NR</sub> = 0.1μF          |                         | 35        |      |                   |
| Turn-On Settling Time           | t <sub>R</sub>    | To V <sub>OUT</sub> = 0.01% of final value | C <sub>NR</sub> = 0     | 0.8       |      | ms                |
|                                 |                   |  | C <sub>NR</sub> = 0.1μF | 20        |      |                   |
| Capacitive-Load Stability Range | C <sub>LOAD</sub> | No sustained oscillations                  |                         | 0.1 to 10 |      | μF                |
| <b>INPUT</b>                    |                   |  |                         |           |      |                   |
| Supply Voltage Range            | V <sub>IN</sub>   | Guaranteed by line-regulation test         | 2.7                     |           | 12.6 | V                 |
| Quiescent Supply Current        | I <sub>IN</sub>   | T <sub>A</sub> = +25°C                     |                         | 380       | 550  | μA                |
|                                 |                   | T <sub>A</sub> = -40°C to +125°C           |                         |           | 725  |                   |

**Electrical Characteristics—MAX6126\_25 (V<sub>OUT</sub> = 2.500V)**(V<sub>IN</sub> = 5V, C<sub>LOAD</sub> = 0.1μF, I<sub>OUT</sub> = 0, T<sub>A</sub> = T<sub>MIN</sub> to T<sub>MAX</sub>, unless otherwise noted. Typical values are at T<sub>A</sub> = +25°C.)

| PARAMETER                                       | SYMBOL                               | CONDITIONS   | MIN                              | TYP   | MAX   | UNITS  |
|---|--------------------------------------|--|----------------------------------|-------|-------|--------|
| <b>OUTPUT</b>                                   |                                      |  |                                  |       |       |        |
| Output Voltage                                  | V <sub>OUT</sub>                     | T <sub>A</sub> = +25°C                                   |                                  | 2.500 |       | V      |
| Output Voltage Accuracy                         |                                      | Referred to V <sub>OUT</sub> ,<br>T <sub>A</sub> = +25°C | A grade SO                       | -0.02 | +0.02 | %      |
|   |                                      |  | B grade SO                       | -0.06 | +0.06 |        |
|   |                                      |  | A grade μMAX                     | -0.06 | +0.06 |        |
|   |                                      |  | B grade μMAX                     | -0.1  | +0.1  |        |
| Output Voltage Temperature Coefficient (Note 1) | TCV <sub>OUT</sub>                   | T <sub>A</sub> = -40°C to +85°C                          | A grade SO                       | 0.5   | 3     | ppm/°C |
|   |                                      |  | B grade SO                       | 1     | 5     |        |
|   |                                      |  | A grade μMAX                     | 1     | 3     |        |
|   |                                      |  | B grade μMAX                     | 2     | 7     |        |
|   |                                      | T <sub>A</sub> = -40°C to +125°C                         | A grade SO                       | 1     | 5     |        |
|   |                                      |  | B grade SO                       | 2     | 10    |        |
|   |                                      |  | A grade μMAX                     | 2     | 5     |        |
|   |                                      |  | B grade μMAX                     | 3     | 12    |        |
| Line Regulation                                 | ΔV <sub>OUT</sub> /ΔV <sub>IN</sub>  | 2.7V ≤ V <sub>IN</sub> ≤ 12.6V                           | T <sub>A</sub> = +25°C           | 3     | 20    | μV/V   |
|   |                                      |  | T <sub>A</sub> = -40°C to +125°C |       | 40    |        |
| Load Regulation                                 | ΔV <sub>OUT</sub> /ΔI <sub>OUT</sub> | Sourcing: 0 ≤ I <sub>OUT</sub> ≤ 10mA                    |                                  | 1     | 25    | μV/mA  |
|   |                                      | Sinking: -10mA ≤ I <sub>OUT</sub> ≤ 0                    |                                  | 1.8   | 25    |        |

**Electrical Characteristics—MAX6126\_25 (V<sub>OUT</sub> = 2.500V) (continued)**(V<sub>IN</sub> = 5V, C<sub>LOAD</sub> = 0.1μF, I<sub>OUT</sub> = 0, T<sub>A</sub> = T<sub>MIN</sub> to T<sub>MAX</sub>, unless otherwise noted. Typical values are at T<sub>A</sub> = +25°C.)

| PARAMETER                       | SYMBOL                             | CONDITIONS                                 |                         | MIN | TYP       | MAX  | UNITS             |
|---------------------------------|------------------------------------|--|-------------------------|-----|-----------|------|-------------------|
| Dropout Voltage (Note 3)        | V <sub>IN</sub> - V <sub>OUT</sub> | ΔV <sub>OUT</sub> = 0.1%                   | I <sub>OUT</sub> = 5mA  |     | 0.06      | 0.2  | V                 |
|                                 |                                    |  | I <sub>OUT</sub> = 10mA |     | 0.12      | 0.4  |                   |
| OUT Short-Circuit Current       | I <sub>SC</sub>                    | Short to GND                               |                         |     | 160       |      | mA                |
|                                 |                                    | Short to IN                                |                         |     | 20        |      |                   |
| Thermal Hysteresis (Note 2)     | ΔV <sub>OUT</sub> /cycle           | SO   |                         |     | 35        |      | ppm               |
|                                 |                                    | μMAX                                       |                         |     | 80        |      |                   |
| Long-Term Stability             | ΔV <sub>OUT</sub> /time            | 1000hr at T <sub>A</sub> = +25°C           | SO                      |     | 20        |      | ppm/1000hr        |
|                                 |                                    |  | μMAX                    |     | 100       |      |                   |
| <b>DYNAMIC CHARACTERISTICS</b>  |                                    |  |                         |     |           |      |                   |
| Noise Voltage                   | e <sub>OUT</sub>                   | f = 0.1Hz to 10Hz                          |                         |     | 1.45      |      | μV <sub>P-P</sub> |
|                                 |                                    | f = 1kHz, C <sub>NR</sub> = 0              |                         |     | 75        |      | nV/√Hz            |
|                                 |                                    | f = 1kHz, C <sub>NR</sub> = 0.1μF          |                         |     | 45        |      |                   |
| Turn-On Settling Time           | t <sub>R</sub>                     | To V <sub>OUT</sub> = 0.01% of final value | C <sub>NR</sub> = 0     |     | 1         |      | ms                |
|                                 |                                    |  | C <sub>NR</sub> = 0.1μF |     | 20        |      |                   |
| Capacitive-Load Stability Range | C <sub>LOAD</sub>                  | No sustained oscillations                  |                         |     | 0.1 to 10 |      | μF                |
| <b>INPUT</b>                    |                                    |  |                         |     |           |      |                   |
| Supply Voltage Range            | V <sub>IN</sub>                    | Guaranteed by line-regulation test         |                         |     | 2.7       | 12.6 | V                 |
| Quiescent Supply Current        | I <sub>IN</sub>                    | T <sub>A</sub> = +25°C                     |                         |     | 380       | 550  | μA                |
|                                 |                                    | T <sub>A</sub> = -40°C to +125°C           |                         |     |           | 725  |                   |

**Electrical Characteristics—MAX6126\_28 (V<sub>OUT</sub> = 2.800V)**(V<sub>IN</sub> = 5V, C<sub>LOAD</sub> = 0.1μF, I<sub>OUT</sub> = 0, T<sub>A</sub> = T<sub>MIN</sub> to T<sub>MAX</sub>, unless otherwise noted. Typical values are at T<sub>A</sub> = +25°C.)

| PARAMETER                                       | SYMBOL                              | CONDITIONS   |                         | MIN                    | TYP   | MAX   | UNITS  |
|---|-------------------------------------|--|-------------------------|------------------------|-------|-------|--------|
| <b>OUTPUT</b>                                   |                                     |  |                         |                        |       |       |        |
| Output Voltage                                  | V <sub>OUT</sub>                    | T <sub>A</sub> = +25°C                                   |                         |                        | 2.800 |       | V      |
| Output Voltage Accuracy                         |                                     | Referred to V <sub>OUT</sub> ,<br>T <sub>A</sub> = +25°C | A grade μMAX            |                        | -0.06 | +0.06 | %      |
|   |                                     |  | B grade μMAX            |                        | -0.10 | +0.10 |        |
| Output Voltage Temperature Coefficient (Note 1) | TCV <sub>OUT</sub>                  | T <sub>A</sub> = -40°C to +85°C                          | A grade μMAX            |                        | 1     | 3     | ppm/°C |
|   |                                     |  | B grade μMAX            |                        | 2     | 7     |        |
|   |                                     | T <sub>A</sub> = -40°C to +125°C                         | A grade μMAX            |                        | 2     | 5     |        |
|   |                                     |  | B grade μMAX            |                        | 3     | 12    |        |
| Line Regulation                                 | ΔV <sub>OUT</sub> /ΔV <sub>IN</sub> | 3.0V ≤ V <sub>IN</sub> ≤ 12.6V                           |                         |                        | 3.5   | 23    | μV/V   |
|   |                                     |  |                         | T <sub>A</sub> = +25°C |       |       |        |
| Load Regulation                                 | ΔV <sub>OUT</sub> /ΔV <sub>IN</sub> | Sourcing: 0 ≤ I <sub>OUT</sub> ≤ 10mA                    |                         |                        | 1.3   | 28    | μV/mA  |
|   |                                     | Sinking: -10mA ≤ I <sub>OUT</sub> ≤ 0                    |                         |                        | 2.4   | 28    |        |
| Dropout Voltage (Note 3)                        | V <sub>IN</sub> - V <sub>OUT</sub>  | ΔV <sub>OUT</sub> = 0.1%                                 | I <sub>OUT</sub> = 5mA  |                        | 0.06  | 0.2   | V      |
|   |                                     |  | I <sub>OUT</sub> = 10mA |                        | 0.12  | 0.4   |        |

**Electrical Characteristics—MAX6126\_28 (V<sub>OUT</sub> = 2.800V) (continued)**(V<sub>IN</sub> = 5V, C<sub>LOAD</sub> = 0.1μF, I<sub>OUT</sub> = 0, T<sub>A</sub> = T<sub>MIN</sub> to T<sub>MAX</sub>, unless otherwise noted. Typical values are at T<sub>A</sub> = +25°C.)

| PARAMETER                       | SYMBOL                   | CONDITIONS                                 |                         | MIN | TYP       | MAX  | UNITS             |
|---------------------------------|--------------------------|--|-------------------------|-----|-----------|------|-------------------|
| OUT Short-Circuit Current       | I <sub>SC</sub>          | Short to GND                               |                         |     | 160       |      | mA                |
|                                 |                          | Short to IN                                |                         |     | 20        |      |                   |
| Thermal Hysteresis (Note 2)     | ΔV <sub>OUT</sub> /cycle | μMAX                                       |                         |     | 80        |      | ppm               |
| Long-Term Stability             | ΔV <sub>OUT</sub> /time  | 1000hr at T <sub>A</sub> = +25°C           | μMAX                    |     | 100       |      | ppm/1000hr        |
| <b>DYNAMIC CHARACTERISTICS</b>  |                          |  |                         |     |           |      |                   |
| Noise Voltage                   | e <sub>OUT</sub>         | f = 0.1Hz to 10Hz                          |                         |     | 1.45      |      | μV <sub>P-P</sub> |
|                                 |                          | f = 1kHz, C <sub>NR</sub> = 0              |                         |     | 75        |      | nV/√Hz            |
|                                 |                          | f = 1kHz, C <sub>NR</sub> = 0.1μF          |                         |     | 45        |      |                   |
| Turn-On Settling Time           | t <sub>R</sub>           | To V <sub>OUT</sub> = 0.01% of final value | C <sub>NR</sub> = 0     |     | 1         |      | ms                |
|                                 |                          |  | C <sub>NR</sub> = 0.1μF |     | 20        |      |                   |
| Capacitive-Load Stability Range | C <sub>LOAD</sub>        | No sustained oscillations                  |                         |     | 0.1 to 10 |      | μF                |
| <b>INPUT</b>                    |                          |  |                         |     |           |      |                   |
| Supply Voltage Range            | V <sub>IN</sub>          | Guaranteed by line-regulation test         |                         | 3.0 |           | 12.6 | V                 |
| Quiescent Supply Current        | I <sub>IN</sub>          | T <sub>A</sub> = +25°C                     |                         |     | 380       | 550  | μA                |
|                                 |                          | T <sub>A</sub> = -40°C to +125°C           |                         |     |           | 725  |                   |

**Electrical Characteristics—MAX6126\_30 (V<sub>OUT</sub> = 3.000V)**(V<sub>IN</sub> = 5V, C<sub>LOAD</sub> = 0.1μF, I<sub>OUT</sub> = 0, T<sub>A</sub> = T<sub>MIN</sub> to T<sub>MAX</sub>, unless otherwise noted. Typical values are at T<sub>A</sub> = +25°C.)

| PARAMETER                                       | SYMBOL             | CONDITIONS   |              | MIN   | TYP   | MAX   | UNITS  |
|---|--------------------|--|--------------|-------|-------|-------|--------|
| <b>OUTPUT</b>                                   |                    |  |              |       |       |       |        |
| Output Voltage                                  | V <sub>OUT</sub>   | T <sub>A</sub> = +25°C                                   |              |       | 3.000 |       | V      |
| Output Voltage Accuracy                         |                    | Referred to V <sub>OUT</sub> ,<br>T <sub>A</sub> = +25°C | A grade SO   | -0.02 |       | +0.02 | %      |
|   |                    |  | B grade SO   | -0.06 |       | +0.06 |        |
|   |                    |  | A grade μMAX | -0.06 |       | +0.06 |        |
|   |                    |  | B grade μMAX | -0.1  |       | +0.1  |        |
| Output Voltage Temperature Coefficient (Note 1) | TCV <sub>OUT</sub> | T <sub>A</sub> = -40°C to +85°C                          | A grade SO   |       | 0.5   | 3     | ppm/°C |
|   |                    |  | B grade SO   |       | 1     | 5     |        |
|   |                    |  | A grade μMAX |       | 1     | 3     |        |
|   |                    |  | B grade μMAX |       | 2     | 7     |        |
|   |                    | T <sub>A</sub> = -40°C to +125°C                         | A grade SO   |       | 1     | 5     |        |
|   |                    |  | B grade SO   |       | 2     | 10    |        |
|   |                    |  | A grade μMAX |       | 2     | 5     |        |
|   |                    |  | B grade μMAX |       | 3     | 12    |        |

**Electrical Characteristics—MAX6126\_30 (V<sub>OUT</sub> = 3.000V) (continued)**(V<sub>IN</sub> = 5V, C<sub>LOAD</sub> = 0.1μF, I<sub>OUT</sub> = 0, T<sub>A</sub> = T<sub>MIN</sub> to T<sub>MAX</sub>, unless otherwise noted. Typical values are at T<sub>A</sub> = +25°C.)

| PARAMETER                       | SYMBOL                                  | CONDITIONS                                 | MIN                              | TYP       | MAX  | UNITS             |
|---------------------------------|---|--|----------------------------------|-----------|------|-------------------|
| Line Regulation                 | $\frac{\Delta V_{OUT}}{\Delta V_{IN}}$  | 3.2V ≤ V <sub>IN</sub> ≤ 12.6V             | T <sub>A</sub> = +25°C           | 4         | 25   | μV/V              |
|                                 |   |  | T <sub>A</sub> = -40°C to +125°C |           | 50   |                   |
| Load Regulation                 | $\frac{\Delta V_{OUT}}{\Delta I_{OUT}}$ | Sourcing: 0 ≤ I <sub>OUT</sub> ≤ 10mA      |                                  | 1.5       | 30   | μV/mA             |
|                                 |   | Sinking: -10mA ≤ I <sub>OUT</sub> ≤ 0      |                                  | 2.8       | 30   |                   |
| Dropout Voltage (Note 3)        | V <sub>IN</sub> - V <sub>OUT</sub>      | ΔV <sub>OUT</sub> = 0.1%                   | I <sub>OUT</sub> = 5mA           | 0.06      | 0.2  | V                 |
|                                 |   |  | I <sub>OUT</sub> = 10mA          | 0.11      | 0.4  |                   |
| OUT Short-Circuit Current       | I <sub>SC</sub>                         | Short to GND                               |                                  | 160       |      | mA                |
|                                 |   | Short to IN                                |                                  | 20        |      |                   |
| Thermal Hysteresis (Note 2)     | $\frac{\Delta V_{OUT}}{\text{cycle}}$   | SO   |                                  | 20        |      | ppm               |
|                                 |   | μMAX                                       |                                  | 80        |      |                   |
| Long-Term Stability             | $\frac{\Delta V_{OUT}}{\text{time}}$    | 1000hr at T <sub>A</sub> = +25°C           | SO                               | 20        |      | ppm/<br>1000hr    |
|                                 |   |  | μMAX                             | 100       |      |                   |
| <b>DYNAMIC CHARACTERISTICS</b>  |   |  |                                  |           |      |                   |
| Noise Voltage                   | e <sub>OUT</sub>                        | f = 0.1Hz to 10Hz                          |                                  | 1.75      |      | μV <sub>p-p</sub> |
|                                 |   | f = 1kHz, C <sub>NR</sub> = 0              |                                  | 90        |      | nV/√Hz            |
|                                 |   | f = 1kHz, C <sub>NR</sub> = 0.1μF          |                                  | 55        |      |                   |
| Capacitive-Load Stability Range | C <sub>LOAD</sub>                       | No sustained oscillations                  |                                  | 0.1 to 10 |      | μF                |
| Turn-On Settling Time           | t <sub>R</sub>                          | To V <sub>OUT</sub> = 0.01% of final value | C <sub>NR</sub> = 0              | 1.2       |      | ms                |
|                                 |   |  | C <sub>NR</sub> = 0.1μF          | 20        |      |                   |
| <b>INPUT</b>                    |   |  |                                  |           |      |                   |
| Supply Voltage Range            | V <sub>IN</sub>                         | Guaranteed by line-regulation test         | 3.2                              |           | 12.6 | V                 |
| Quiescent Supply Current        | I <sub>IN</sub>                         | T <sub>A</sub> = +25°C                     |                                  | 380       | 550  | μA                |
|                                 |   | T <sub>A</sub> = -40°C to +125°C           |                                  |           | 725  |                   |

**Electrical Characteristics—MAX6126\_33 (V<sub>OUT</sub> = 3.300V)**(V<sub>IN</sub> = 5V, C<sub>LOAD</sub> = 0.1μF, I<sub>OUT</sub> = 0, T<sub>A</sub> = T<sub>MIN</sub> to T<sub>MAX</sub>, unless otherwise noted. Typical values are at T<sub>A</sub> = +25°C.)

| PARAMETER                                       | SYMBOL                               | CONDITIONS   |                                  | MIN                     | TYP       | MAX   | UNITS             |
|---|--------------------------------------|--|----------------------------------|-------------------------|-----------|-------|-------------------|
| <b>OUTPUT</b>                                   |                                      |  |                                  |                         |           |       |                   |
| Output Voltage                                  | V <sub>OUT</sub>                     | T <sub>A</sub> = +25°C                                   |                                  | 3.300                   |           |       | V                 |
| Output Voltage Accuracy                         |                                      | Referred to V <sub>OUT</sub> ,<br>T <sub>A</sub> = +25°C | A grade SO                       | -0.02                   |           | +0.02 | %                 |
|   |                                      |  | B grade SO                       | -0.06                   |           | +0.06 |                   |
|   |                                      |  | A grade μMAX                     | -0.06                   |           | +0.06 |                   |
|   |                                      |  | B grade μMAX                     | -0.1                    |           | +0.1  |                   |
| Output Voltage Temperature Coefficient (Note 1) | TCV <sub>OUT</sub>                   | T <sub>A</sub> = -40°C to +85°C                          | A grade SO                       |                         | 0.5       | 3     | ppm/°C            |
|   |                                      |  | B grade SO                       |                         | 1         | 5     |                   |
|   |                                      |  | A grade μMAX                     |                         | 1         | 3     |                   |
|   |                                      |  | B grade μMAX                     |                         | 2         | 7     |                   |
|   |                                      | T <sub>A</sub> = -40°C to +125°C                         | A grade SO                       |                         | 1         | 5     |                   |
|   |                                      |  | B grade SO                       |                         | 2         | 10    |                   |
|   |                                      |  | A grade μMAX                     |                         | 2         | 5     |                   |
|   |                                      |  | B grade μMAX                     |                         | 3         | 12    |                   |
| Line Regulation                                 | ΔV <sub>OUT</sub> /ΔV <sub>IN</sub>  | 3.5V ≤ V <sub>IN</sub> ≤ 12.6V                           | T <sub>A</sub> = +25°C           |                         | 11        | 35    | μV/V              |
|   |                                      |  | T <sub>A</sub> = -40°C to +125°C |                         |           | 70    |                   |
| Load Regulation                                 | ΔV <sub>OUT</sub> /ΔI <sub>OUT</sub> | Sourcing: 0 ≤ I <sub>OUT</sub> ≤ 10mA                    |                                  |                         | 2         | 40    | μV/mA             |
|   |                                      | Sinking: -10mA ≤ I <sub>OUT</sub> ≤ 0                    |                                  |                         | 5         | 40    |                   |
| Dropout Voltage (Note 3)                        | V <sub>IN</sub> - V <sub>OUT</sub>   | ΔV <sub>OUT</sub> = 0.1%                                 | I <sub>OUT</sub> = 5mA           |                         | 0.06      | 0.2   | V                 |
|   |                                      |  | I <sub>OUT</sub> = 10mA          |                         | 0.12      | 0.4   |                   |
| OUT Short-Circuit Current                       | I <sub>SC</sub>                      | Short to GND   |                                  |                         | 160       |       | mA                |
|   |                                      | Short to IN  |                                  |                         | 20        |       |                   |
| Thermal Hysteresis (Note 2)                     | ΔV <sub>OUT</sub> /cycle             | SO   |                                  |                         | 20        |       | ppm               |
|   |                                      | μMAX   |                                  |                         | 80        |       |                   |
| Long-Term Stability                             | ΔV <sub>OUT</sub> /time              | 1000hr at T <sub>A</sub> = +25°C                         |                                  | SO                      |           | 20    | ppm/1000hr        |
|   |                                      |  |                                  | μMAX                    |           | 100   |                   |
| <b>DYNAMIC CHARACTERISTICS</b>                  |                                      |  |                                  |                         |           |       |                   |
| Noise Voltage                                   | e <sub>OUT</sub>                     | f = 0.1Hz to 10Hz  |                                  |                         | 1.95      |       | μV <sub>P-P</sub> |
|   |                                      | f = 1kHz, C <sub>NR</sub> = 0                            |                                  |                         | 100       |       | nV/√Hz            |
|   |                                      | f = 1kHz, C <sub>NR</sub> = 0.1μF                        |                                  |                         | 60        |       |                   |
| Capacitive-Load Stability Range                 | C <sub>LOAD</sub>                    | No sustained oscillations                                |                                  |                         | 0.1 to 10 |       | μF                |
| Turn-On Settling Time                           | t <sub>R</sub>                       | To V <sub>OUT</sub> = 0.01% of final value               |                                  | C <sub>NR</sub> = 0     |           | 1.2   | ms                |
|   |                                      |  |                                  | C <sub>NR</sub> = 0.1μF |           | 20    |                   |
| <b>INPUT</b>                                    |                                      |  |                                  |                         |           |       |                   |
| Supply Voltage Range                            | V <sub>IN</sub>                      | Guaranteed by line-regulation test                       |                                  | 3.5                     |           | 12.6  | V                 |
| Quiescent Supply Current                        | I <sub>IN</sub>                      | T <sub>A</sub> = +25°C                                   |                                  |                         | 380       | 550   | μA                |
|   |                                      | T <sub>A</sub> = -40°C to +125°C                         |                                  |                         |           | 725   |                   |

**Electrical Characteristics—MAX6126\_36 (V<sub>OUT</sub> = 3.600V)**(V<sub>IN</sub> = 5V, C<sub>LOAD</sub> = 0.1μF, I<sub>OUT</sub> = 0, T<sub>A</sub> = T<sub>MIN</sub> to T<sub>MAX</sub>, unless otherwise noted. Typical values are at T<sub>A</sub> = +25°C.)

| PARAMETER                                       | SYMBOL                               | CONDITIONS   |                                  | MIN   | TYP       | MAX   | UNITS             |
|---|--------------------------------------|--|----------------------------------|-------|-----------|-------|-------------------|
| <b>OUTPUT</b>                                   |                                      |  |                                  |       |           |       |                   |
| Output Voltage                                  | V <sub>OUT</sub>                     | T <sub>A</sub> = +25°C                                   |                                  | 3.6   |           |       | V                 |
| Output Voltage Accuracy                         |                                      | Referred to V <sub>OUT</sub> ,<br>T <sub>A</sub> = +25°C | A grade SO                       | -0.02 |           | +0.02 | %                 |
|   |                                      |  | B grade SO                       | -0.06 |           | +0.06 |                   |
|   |                                      |  | A grade μMAX                     | -0.06 |           | +0.06 |                   |
|   |                                      |  | B grade μMAX                     | -0.1  |           | +0.1  |                   |
| Output Voltage Temperature Coefficient (Note 1) | TCV <sub>OUT</sub>                   | T <sub>A</sub> = -40°C to +85°C                          | A grade SO                       |       | 0.5       | 3     | ppm/°C            |
|   |                                      |  | B grade SO                       |       | 1         | 5     |                   |
|   |                                      |  | A grade μMAX                     |       | 1         | 3     |                   |
|   |                                      |  | B grade μMAX                     |       | 2         | 7     |                   |
|   |                                      | T <sub>A</sub> = -40°C to +125°C                         | A grade SO                       |       | 1         | 5     |                   |
|   |                                      |  | B grade SO                       |       | 2         | 10    |                   |
|   |                                      |  | A grade μMAX                     |       | 2         | 5     |                   |
|   |                                      |  | B grade μMAX                     |       | 3         | 12    |                   |
| Line Regulation                                 | ΔV <sub>OUT</sub> /ΔV <sub>IN</sub>  | 3.8V ≤ V <sub>IN</sub> ≤ 12.6V                           | T <sub>A</sub> = +25°C           |       | 12        | 40    | μV/V              |
|   |                                      |  | T <sub>A</sub> = -40°C to +125°C |       |           | 80    |                   |
| Load Regulation                                 | ΔV <sub>OUT</sub> /ΔI <sub>OUT</sub> | Sourcing: 0 ≤ I <sub>OUT</sub> ≤ 10mA                    |                                  |       | 2         | 50    | μV/mA             |
|   |                                      | Sinking: -10mA ≤ I <sub>OUT</sub> ≤ 0                    |                                  |       | 6         | 50    |                   |
| Dropout Voltage (Note 3)                        | V <sub>IN</sub> - V <sub>OUT</sub>   | ΔV <sub>OUT</sub> = 0.1%                                 | I <sub>OUT</sub> = 5mA           |       | 0.05      | 0.2   | V                 |
|   |                                      |  | I <sub>OUT</sub> = 10mA          |       | 0.11      | 0.4   |                   |
| OUT Short-Circuit Current                       | I <sub>SC</sub>                      | Short to GND   |                                  |       | 160       |       | mA                |
|   |                                      | Short to IN  |                                  |       | 20        |       |                   |
| Thermal Hysteresis (Note 2)                     | ΔV <sub>OUT</sub> /cycle             | SO   |                                  |       | 20        |       | ppm               |
|   |                                      | μMAX   |                                  |       | 80        |       |                   |
| Long-Term Stability                             | ΔV <sub>OUT</sub> /time              | 1000hr at T <sub>A</sub> = +25°C                         | SO                               |       | 20        |       | ppm/1000hr        |
|   |                                      |  | μMAX                             |       | 100       |       |                   |
| <b>DYNAMIC CHARACTERISTICS</b>                  |                                      |  |                                  |       |           |       |                   |
| Noise Voltage                                   | e <sub>OUT</sub>                     | f = 0.1Hz to 10Hz  |                                  |       | 2.1       |       | μV <sub>P-P</sub> |
|   |                                      | f = 1kHz, C <sub>NR</sub> = 0                            |                                  |       | 110       |       | nV/√Hz            |
|   |                                      | f = 1kHz, C <sub>NR</sub> = 0.1μF                        |                                  |       | 66        |       |                   |
| Capacitive-Load Stability Range                 | C <sub>LOAD</sub>                    | No sustained oscillations                                |                                  |       | 0.1 to 10 |       | μF                |
| Turn-On Settling Time                           | t <sub>R</sub>                       | To V <sub>OUT</sub> = 0.01% of final value               | C <sub>NR</sub> = 0              |       | 1.6       |       | ms                |
|   |                                      |  | C <sub>NR</sub> = 0.1μF          |       | 20        |       |                   |
| <b>INPUT</b>                                    |                                      |  |                                  |       |           |       |                   |
| Supply Voltage Range                            | V <sub>IN</sub>                      | Guaranteed by line-regulation test                       |                                  | 3.8   |           | 12.6  | V                 |
| Quiescent Supply Current                        | I <sub>IN</sub>                      | T <sub>A</sub> = +25°C                                   |                                  |       | 380       | 550   | μA                |
|   |                                      | T <sub>A</sub> = -40°C to +125°C                         |                                  |       |           | 725   |                   |



**Electrical Characteristics—MAX6126\_41 (V<sub>OUT</sub> = 4.096V)**(V<sub>IN</sub> = 5V, C<sub>LOAD</sub> = 0.1μF, I<sub>OUT</sub> = 0, T<sub>A</sub> = T<sub>MIN</sub> to T<sub>MAX</sub>, unless otherwise noted. Typical values are at T<sub>A</sub> = +25°C.)

| PARAMETER                                       | SYMBOL                               | CONDITIONS   |                                  | MIN   | TYP       | MAX   | UNITS             |
|---|--------------------------------------|--|----------------------------------|-------|-----------|-------|-------------------|
| <b>OUTPUT</b>                                   |                                      |  |                                  |       |           |       |                   |
| Output Voltage                                  | V <sub>OUT</sub>                     | T <sub>A</sub> = +25°C                                   |                                  | 4.096 |           |       | V                 |
| Output Voltage Accuracy                         |                                      | Referred to V <sub>OUT</sub> ,<br>T <sub>A</sub> = +25°C | A grade SO                       | -0.02 |           | +0.02 | %                 |
|   |                                      |  | B grade SO                       | -0.06 |           | +0.06 |                   |
|   |                                      |  | A grade μMAX                     | -0.06 |           | +0.06 |                   |
|   |                                      |  | B grade μMAX                     | -0.1  |           | +0.1  |                   |
| Output Voltage Temperature Coefficient (Note 1) | TCV <sub>OUT</sub>                   | T <sub>A</sub> = -40°C to +85°C                          | A grade SO                       |       | 0.5       | 3     | ppm/°C            |
|   |                                      |  | B grade SO                       |       | 1         | 5     |                   |
|   |                                      |  | A grade μMAX                     |       | 1         | 3     |                   |
|   |                                      |  | B grade μMAX                     |       | 2         | 7     |                   |
|   |                                      | T <sub>A</sub> = -40°C to +125°C                         | A grade SO                       |       | 1         | 5     |                   |
|   |                                      |  | B grade SO                       |       | 2         | 10    |                   |
|   |                                      |  | A grade μMAX                     |       | 2         | 5     |                   |
|   |                                      |  | B grade μMAX                     |       | 3         | 12    |                   |
| Line Regulation                                 | ΔV <sub>OUT</sub> /ΔV <sub>IN</sub>  | 4.3V ≤ V <sub>IN</sub> ≤ 12.6V                           | T <sub>A</sub> = +25°C           |       | 4.5       | 30    | μV/V              |
|   |                                      |  | T <sub>A</sub> = -40°C to +125°C |       |           | 60    |                   |
| Load Regulation                                 | ΔV <sub>OUT</sub> /ΔI <sub>OUT</sub> | Sourcing: 0 ≤ I <sub>OUT</sub> ≤ 10mA                    |                                  |       | 2         | 40    | μV/mA             |
|   |                                      | Sinking: -10mA ≤ I <sub>OUT</sub> ≤ 0                    |                                  |       | 5         | 40    |                   |
| Dropout Voltage (Note 3)                        | V <sub>IN</sub> - V <sub>OUT</sub>   | ΔV <sub>OUT</sub> = 0.1%                                 | I <sub>OUT</sub> = 5mA           |       | 0.05      | 0.2   | V                 |
|   |                                      |  | I <sub>OUT</sub> = 10mA          |       | 0.1       | 0.4   |                   |
| OUT Short-Circuit Current                       | I <sub>SC</sub>                      | Short to GND   |                                  |       | 160       |       | mA                |
|   |                                      | Short to IN  |                                  |       | 20        |       |                   |
| Thermal Hysteresis (Note 2)                     | ΔV <sub>OUT</sub> /cycle             | SO   |                                  |       | 20        |       | ppm               |
|   |                                      | μMAX   |                                  |       | 80        |       |                   |
| Long-Term Stability                             | ΔV <sub>OUT</sub> /time              | 1000hr at T <sub>A</sub> = +25°C                         | SO                               |       | 20        |       | ppm/1000hr        |
|   |                                      |  | μMAX                             |       | 100       |       |                   |
| <b>DYNAMIC CHARACTERISTICS</b>                  |                                      |  |                                  |       |           |       |                   |
| Noise Voltage                                   | e <sub>OUT</sub>                     | f = 0.1Hz to 10Hz  |                                  |       | 2.4       |       | μV <sub>P-P</sub> |
|   |                                      | f = 1kHz, C <sub>NR</sub> = 0                            |                                  |       | 120       |       | nV/√Hz            |
|   |                                      | f = 1kHz, C <sub>NR</sub> = 0.1μF                        |                                  |       | 80        |       |                   |
| Capacitive-Load Stability Range                 | C <sub>LOAD</sub>                    | No sustained oscillations                                |                                  |       | 0.1 to 10 |       | μF                |
| Turn-On Settling Time                           | t <sub>R</sub>                       | To V <sub>OUT</sub> = 0.01% of final value               | C <sub>NR</sub> = 0              |       | 1.6       |       | ms                |
|   |                                      |  | C <sub>NR</sub> = 0.1μF          |       | 20        |       |                   |
| <b>INPUT</b>                                    |                                      |  |                                  |       |           |       |                   |
| Supply Voltage Range                            | V <sub>IN</sub>                      | Guaranteed by line-regulation test                       |                                  | 4.3   |           | 12.6  | V                 |
| Quiescent Supply Current                        | I <sub>IN</sub>                      | T <sub>A</sub> = +25°C                                   |                                  |       | 380       | 550   | μA                |
|   |                                      | T <sub>A</sub> = -40°C to +125°C                         |                                  |       |           | 725   |                   |

**Electrical Characteristics—MAX6126\_50 (V<sub>OUT</sub> = 5.000V)**(V<sub>IN</sub> = 5.5V, C<sub>LOAD</sub> = 0.1μF, I<sub>OUT</sub> = 0, T<sub>A</sub> = T<sub>MIN</sub> to T<sub>MAX</sub>, unless otherwise noted. Typical values are at T<sub>A</sub> = +25°C.)

| PARAMETER                                       | SYMBOL                               | CONDITIONS                            |                                  | MIN   | TYP       | MAX   | UNITS             |
|---|--------------------------------------|---------------------------------------|----------------------------------|-------|-----------|-------|-------------------|
| <b>OUTPUT</b>                                   |                                      |                                       |                                  |       |           |       |                   |
| Output Voltage                                  | V <sub>OUT</sub>                     | T <sub>A</sub> = +25°C                |                                  | 5.000 |           |       | V                 |
| Output Voltage Accuracy                         |                                      | T <sub>A</sub> = +25°C                | A grade SO                       | -0.02 |           | +0.02 | %                 |
|   |                                      |                                       | B grade SO                       | -0.06 |           | +0.06 |                   |
|   |                                      |                                       | A grade μMAX                     | -0.06 |           | +0.06 |                   |
|   |                                      |                                       | B grade μMAX                     | -0.1  |           | +0.1  |                   |
| Output Voltage Temperature Coefficient (Note 1) | TCV <sub>OUT</sub>                   | T <sub>A</sub> = -40°C to +85°C       | A grade SO                       |       | 0.5       | 3     | ppm/°C            |
|   |                                      |                                       | B grade SO                       |       | 1         | 5     |                   |
|   |                                      |                                       | A grade μMAX                     |       | 1         | 3     |                   |
|   |                                      |                                       | B grade μMAX                     |       | 2         | 7     |                   |
|   |                                      | T <sub>A</sub> = -40°C to +125°C      | A grade SO                       |       | 1         | 5     |                   |
|   |                                      |                                       | B grade SO                       |       | 2         | 10    |                   |
|   |                                      |                                       | A grade μMAX                     |       | 2         | 5     |                   |
|   |                                      |                                       | B grade μMAX                     |       | 3         | 12    |                   |
| Line Regulation                                 | ΔV <sub>OUT</sub> /ΔV <sub>IN</sub>  | 5.2V ≤ V <sub>IN</sub> ≤ 12.6V        | T <sub>A</sub> = +25°C           |       | 3         | 40    | μV/V              |
|   |                                      |                                       | T <sub>A</sub> = -40°C to +125°C |       |           | 80    |                   |
| Load Regulation                                 | ΔV <sub>OUT</sub> /ΔI <sub>OUT</sub> | Sourcing: 0 ≤ I <sub>OUT</sub> ≤ 10mA |                                  |       | 2.5       | 50    | μV/mA             |
|   |                                      | Sinking: -10mA ≤ I <sub>OUT</sub> ≤ 0 |                                  |       | 6.5       | 50    |                   |
| Dropout Voltage (Note 3)                        | V <sub>IN</sub> - V <sub>OUT</sub>   | ΔV <sub>OUT</sub> = 0.1%              | I <sub>OUT</sub> = 5mA           |       | 0.05      | 0.2   | V                 |
|   |                                      |                                       | I <sub>OUT</sub> = 10mA          |       | 0.1       | 0.4   |                   |
| OUT Short-Circuit Current                       | I <sub>SC</sub>                      | Short to GND                          |                                  |       | 160       |       | mA                |
|   |                                      | Short to IN                           |                                  |       | 20        |       |                   |
| Thermal Hysteresis (Note 2)                     | ΔV <sub>OUT</sub> /cycle             | SO                                    |                                  |       | 15        |       | ppm               |
|   |                                      | μMAX                                  |                                  |       | 80        |       |                   |
| Long-Term Stability                             | ΔV <sub>OUT</sub> /time              | 1000hr at T <sub>A</sub> = +25°C      |                                  | SO    |           | 20    | ppm/1000hr        |
|   |                                      |                                       |                                  | μMAX  |           | 100   |                   |
| <b>DYNAMIC CHARACTERISTICS</b>                  |                                      |                                       |                                  |       |           |       |                   |
| Noise Voltage                                   | e <sub>OUT</sub>                     | f = 0.1Hz to 10Hz                     |                                  |       | 2.85      |       | μV <sub>P-P</sub> |
|   |                                      | f = 1kHz, C <sub>NR</sub> = 0         |                                  |       | 145       |       | nV/√Hz            |
|   |                                      | f = 1kHz, C <sub>NR</sub> = 0.1μF     |                                  |       | 95        |       |                   |
| Capacitive-Load Stability Range                 | C <sub>LOAD</sub>                    | No sustained oscillations             |                                  |       | 0.1 to 10 |       | μF                |

**Electrical Characteristics—MAX6126\_50 (V<sub>OUT</sub> = 5.000V) (continued)**

(V<sub>IN</sub> = 5.5V, C<sub>LOAD</sub> = 0.1μF, I<sub>OUT</sub> = 0, T<sub>A</sub> = T<sub>MIN</sub> to T<sub>MAX</sub>, unless otherwise noted. Typical values are at T<sub>A</sub> = +25°C.)

| PARAMETER                | SYMBOL          | CONDITIONS                                 | MIN                     | TYP | MAX  | UNITS |
|--------------------------|-----------------|--|-------------------------|-----|------|-------|
| Turn-On Settling Time    | t <sub>R</sub>  | To V <sub>OUT</sub> = 0.01% of final value | C <sub>NR</sub> = 0     |     | 2    | ms    |
|                          |                 |  | C <sub>NR</sub> = 0.1μF |     | 20   |       |
| <b>INPUT</b>             |                 |  |                         |     |      |       |
| Supply Voltage Range     | V <sub>IN</sub> | Guaranteed by line-regulation test         | 5.2                     |     | 12.6 | V     |
| Quiescent Supply Current | I <sub>IN</sub> | T <sub>A</sub> = +25°C                     |                         | 380 | 550  | μA    |
|                          |                 | T <sub>A</sub> = -40°C to +125°C           |                         |     | 725  |       |

- Note 1:** Temperature coefficient is measured by the “box” method, i.e., the maximum ΔV<sub>OUT</sub>/V<sub>OUT</sub> is divided by the maximum ΔT.
- Note 2:** Thermal hysteresis is defined as the change in +25°C output voltage before and after cycling the device from T<sub>MAX</sub> to T<sub>MIN</sub>.
- Note 3:** Dropout voltage is defined as the minimum differential voltage (V<sub>IN</sub> - V<sub>OUT</sub>) at which V<sub>OUT</sub> decreases by 0.1% from its original value at V<sub>IN</sub> = 5.0V (V<sub>IN</sub> = 5.5V for V<sub>OUT</sub> = 5.0V).

**Typical Operating Characteristics**

(V<sub>IN</sub> = 5V for MAX6126\_21/25/30/33/36/41, V<sub>IN</sub> = 5.5V for MAX6126\_50, C<sub>LOAD</sub> = 0.1μF, I<sub>OUT</sub> = 0, T<sub>A</sub> = +25°C, unless otherwise specified.) (Note 5)

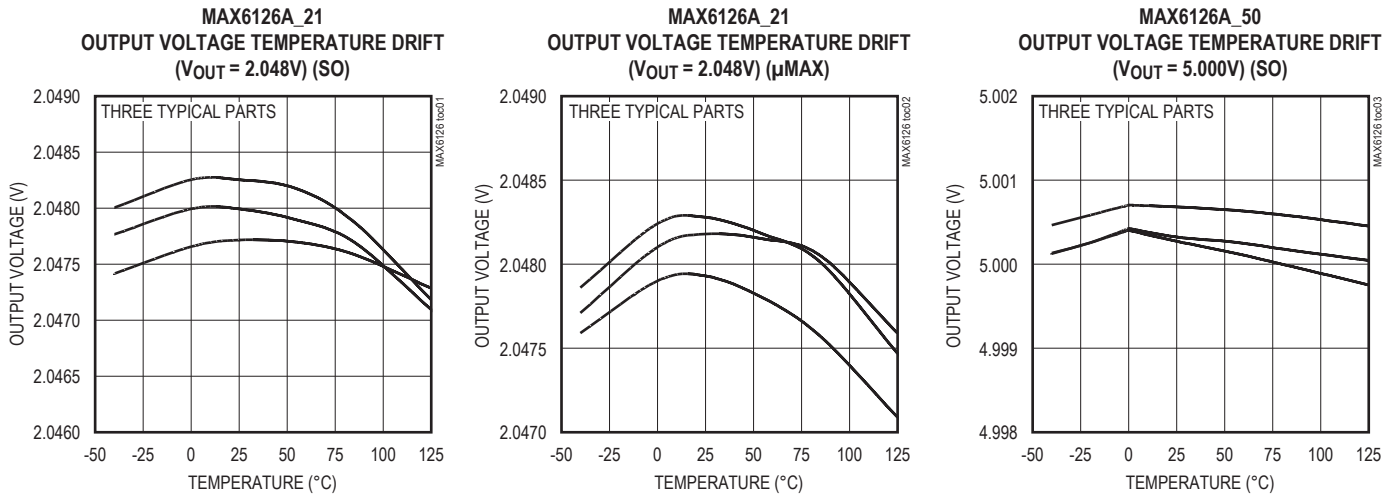

Typical Operating Characteristics (continued)

( $V_{IN} = 5V$  for MAX6126\_21/25/30/33/36/41,  $V_{IN} = 5.5V$  for MAX6126\_50,  $C_{LOAD} = 0.1\mu F$ ,  $I_{OUT} = 0$ ,  $T_A = +25^\circ C$ , unless otherwise specified.) (Note 5)

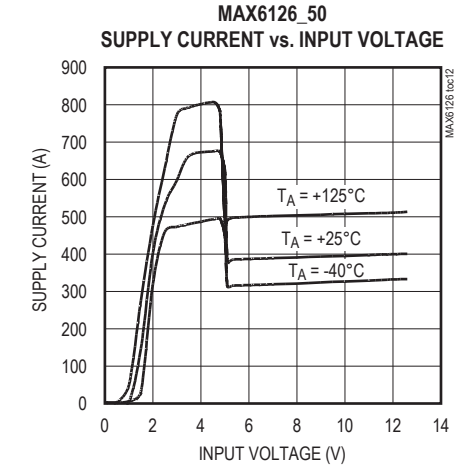
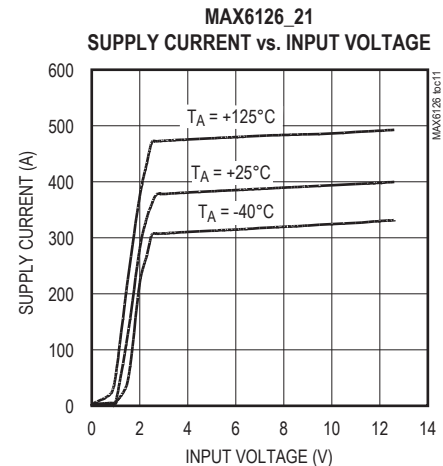
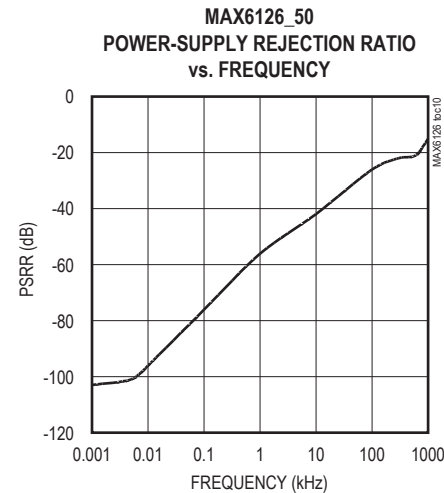
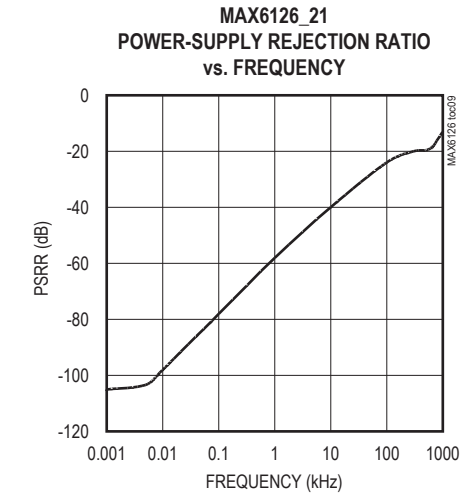
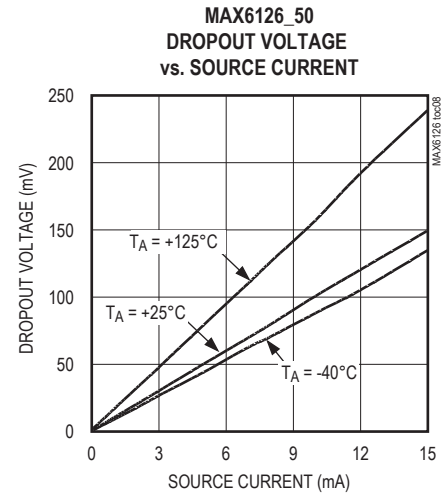
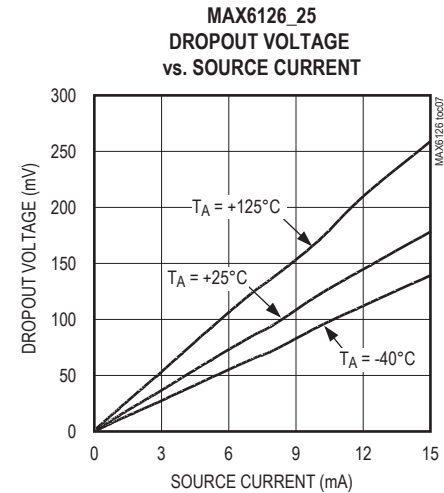
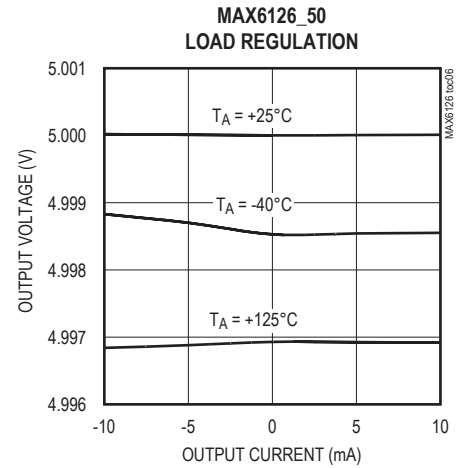
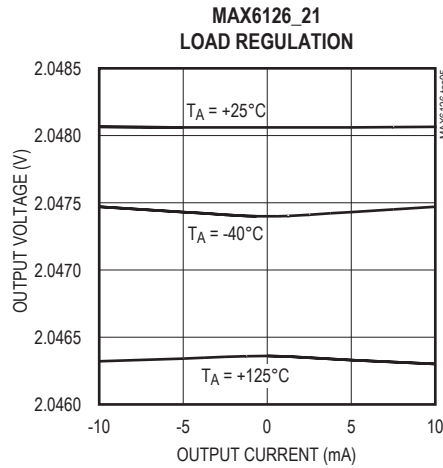
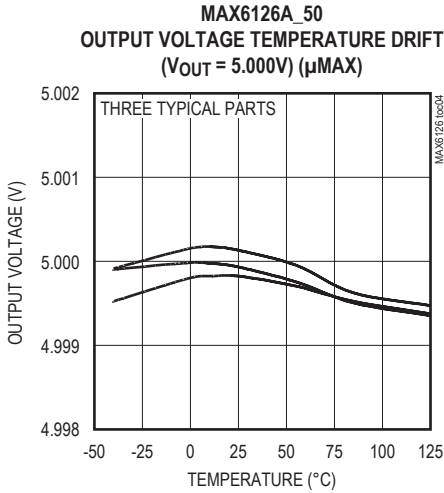

Typical Operating Characteristics (continued)

( $V_{IN} = 5V$  for MAX6126\_21/25/30/33/36/41,  $V_{IN} = 5.5V$  for MAX6126\_50,  $C_{LOAD} = 0.1\mu F$ ,  $I_{OUT} = 0$ ,  $T_A = +25^\circ C$ , unless otherwise specified.) (Note 5)

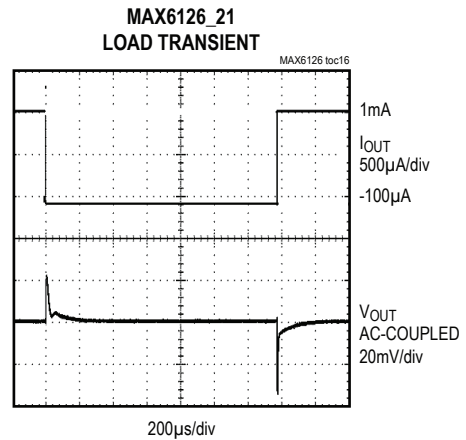
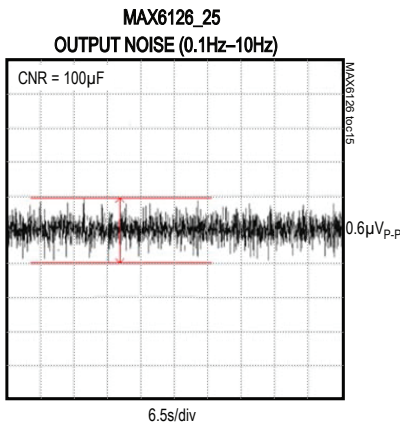
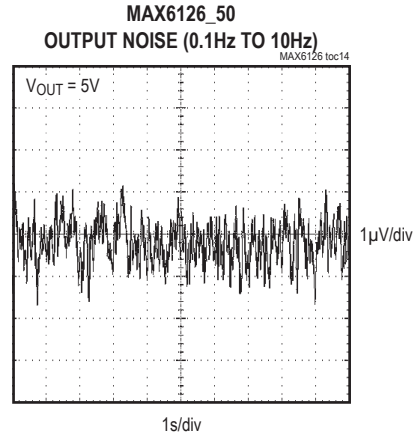
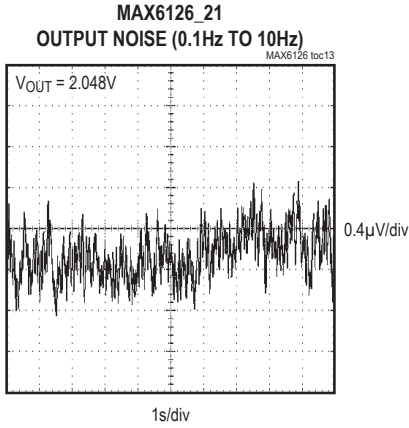

$C_{LOAD} = 0.1\mu F$   $I_{OUT} = -100\mu A$  TO 1mA  
 $V_{IN} = 5V$   $V_{OUT} = 2.048V$

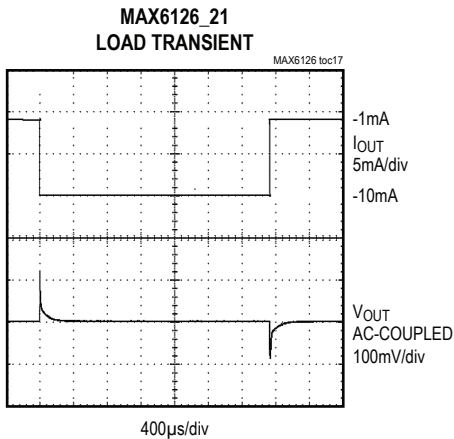

$C_{LOAD} = 0.1\mu F$   $I_{OUT} = -1mA$  TO -10mA  
 $V_{IN} = 5V$   $V_{OUT} = 2.048V$

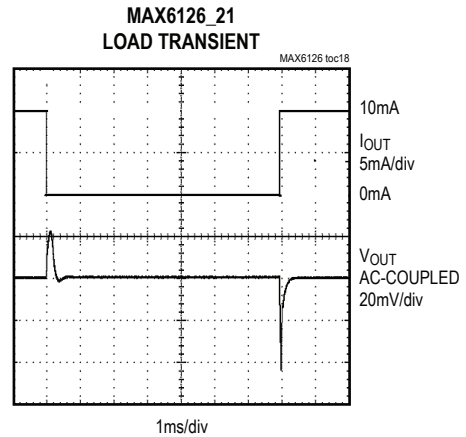

$C_{LOAD} = 10\mu F$   $I_{OUT} = 0$  TO 10mA  
 $V_{IN} = 5V$   $V_{OUT} = 2.048V$

Typical Operating Characteristics (continued)

( $V_{IN} = 5V$  for MAX6126\_21/25/30/33/36/41,  $V_{IN} = 5.5V$  for MAX6126\_50,  $C_{LOAD} = 0.1\mu F$ ,  $I_{OUT} = 0$ ,  $T_A = +25^\circ C$ , unless otherwise specified.) (Note 5)

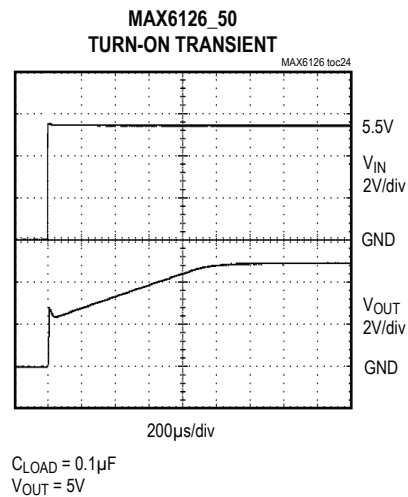
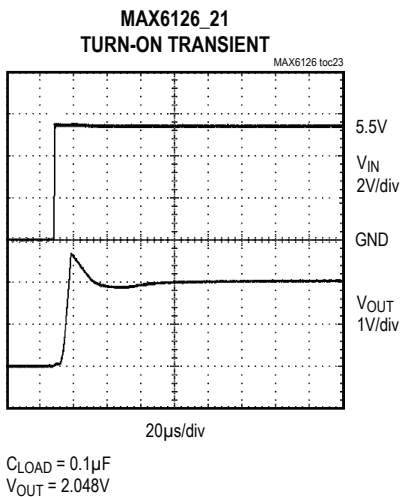
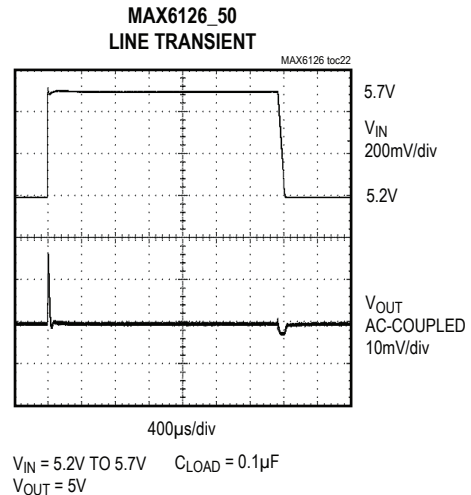
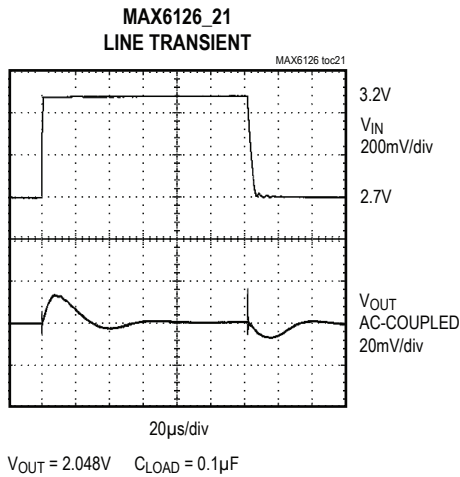
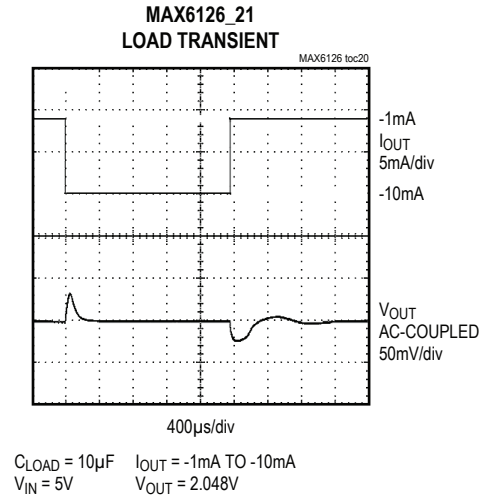
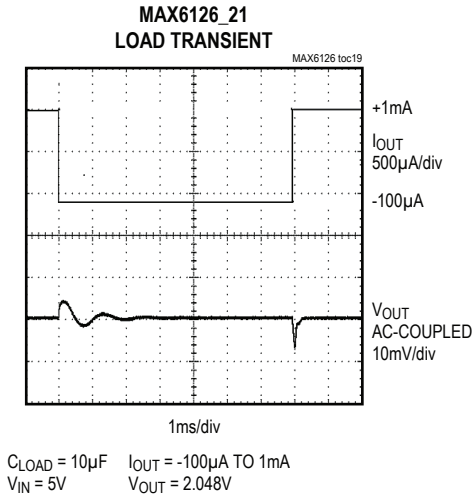

Typical Operating Characteristics (continued)

( $V_{IN} = 5V$  for MAX6126\_21/25/30/33/36/41,  $V_{IN} = 5.5V$  for MAX6126\_50,  $C_{LOAD} = 0.1\mu F$ ,  $I_{OUT} = 0$ ,  $T_A = +25^\circ C$ , unless otherwise specified.) (Note 5)

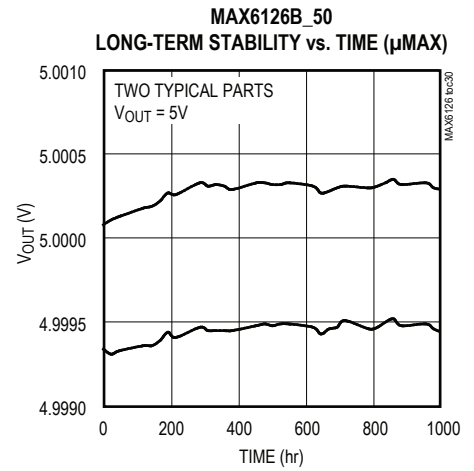
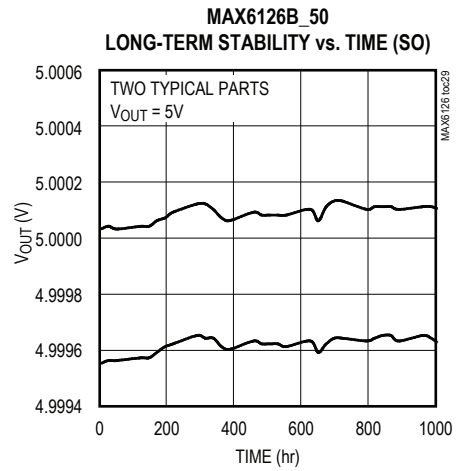
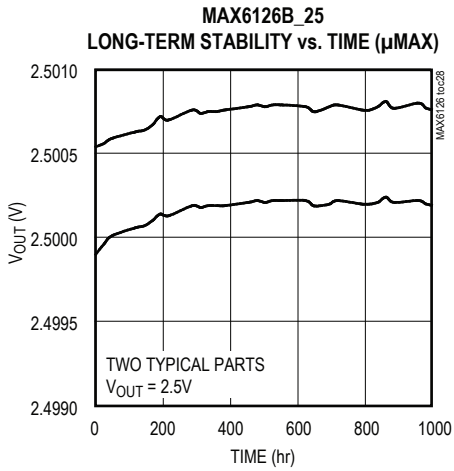
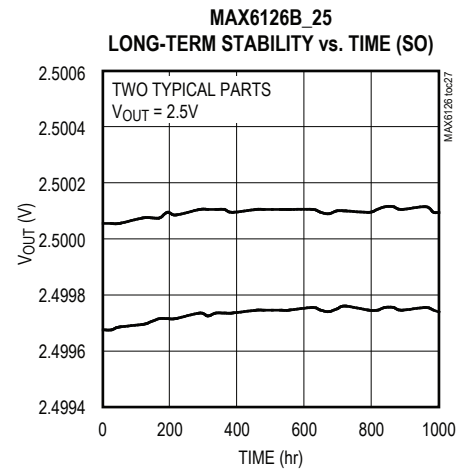
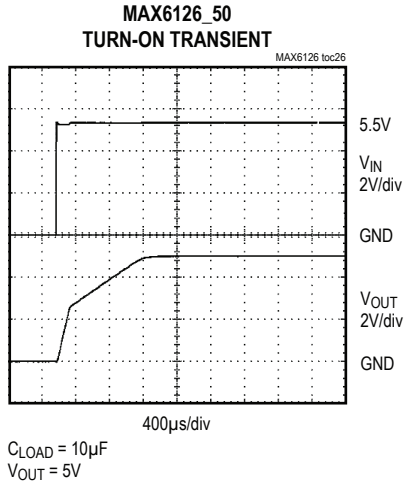
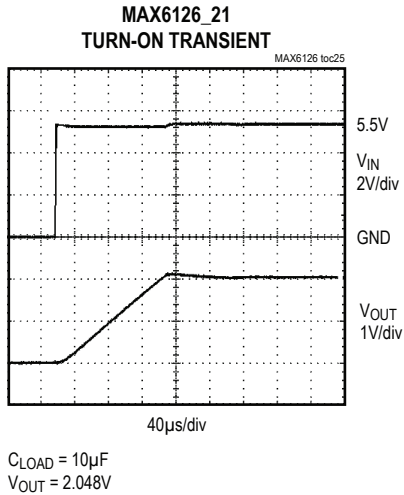

**Note 5:** Many of the MAX6126 *Typical Operating Characteristics* are extremely similar. The extremes of these characteristics are found in the MAX6126\_21 (2.048V output) and the MAX6126\_50 (5.000V output). The *Typical Operating Characteristics* of the remainder of the MAX6126 family typically lie between those two extremes and can be estimated based on their output voltages.

Pin Description

| PIN  | NAME | FUNCTION  |
|------|------|---|
| 1    | NR   | Noise Reduction. Connect a 0.1µF capacitor to improve wideband noise. Leave unconnected if not used (see <a href="#">Figure 1</a> ).      |
| 2    | IN   | Positive Power-Supply Input   |
| 3    | GND  | Ground  |
| 4    | GNDS | Ground-Sense Connection. Connect to ground connection at load.  |
| 5, 8 | I.C. | Internally Connected. <b>Do not connect anything to these pins.</b>   |
| 6    | OUTS | Voltage Reference Sense Output  |
| 7    | OUTF | Voltage Reference Force Output. Short OUTF to OUTS as close to the load as possible. Bypass OUTF with a capacitor (0.1µF to 10µF) to GND. |

Detailed Description

Wideband Noise Reduction

To improve wideband noise and transient power-supply noise, add a 0.1µF capacitor to NR ([Figure 1](#)). A 0.1µF NR capacitor reduces the noise from 60nV/√Hz to 35nV/√Hz for the 2.048V output. Noise in the power-supply input can affect output noise, but can be reduced by adding an optional bypass capacitor between IN and GND, as shown in the [Typical Operating Circuit](#). The 0.1Hz to 10Hz noise when measured with a 0.1µF noise reduction capacitor (NR pin) is 0.9µV<sub>p-p</sub>. Using a 100µF noise reduction capacitor (NR pin) reduces the 0.1Hz to 10Hz noise to 0.6µV<sub>p-p</sub>.

Output Bypassing

The MAX6126 requires an output capacitor between 0.1µF and 10µF. Locate the output capacitor as close to OUTF as possible. For applications driving switching capacitive loads or rapidly changing load currents, it is advantageous to use a 10µF capacitor in parallel with a 0.1µF capacitor. Larger capacitor values reduce transients on the reference output.

Supply Current

The quiescent supply current of the series-mode MAX6126 family is typically 380µA and is virtually independent of the supply voltage, with only a 2µA/V (max) variation with supply voltage.

When the supply voltage is below the minimum specified input voltage during turn-on, the device can draw up to 300µA beyond the nominal supply current. The input voltage source must be capable of providing this current to ensure reliable turn-on.

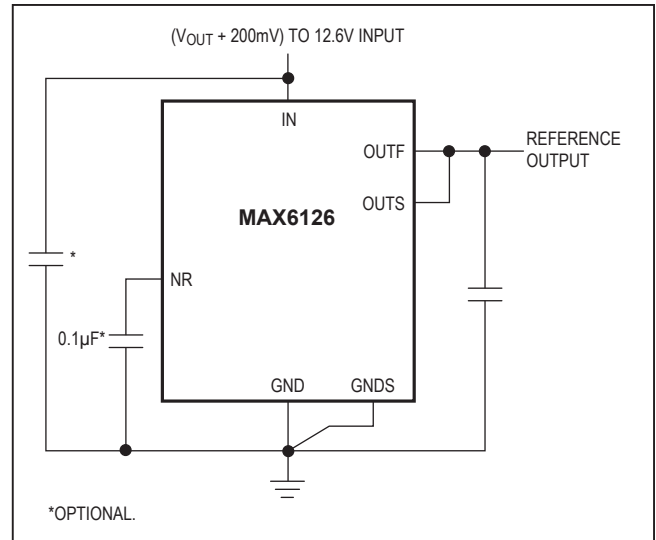

Figure 1. Noise-Reduction Capacitor

Thermal Hysteresis

Thermal hysteresis is the change of output voltage at T<sub>A</sub> = +25°C before and after the device is cycled over its entire operating temperature range. The typical thermal hysteresis value is 20ppm (SO package).

Turn-On Time

These devices typically turn on and settle to within 0.1% of their final value in 200µs to 2ms depending on the device. The turn-on time can increase up to 4ms with the device operating at the minimum dropout voltage and the maximum load. A noise reduction capacitor of 0.1µF increases the turn-on time to 20ms.

Output Force and Sense

The MAX6126 provides independent connections for the power-circuit output (OUTF) supplying current into a load, and for the circuit input regulating the voltage applied to that load (OUTS). This configuration allows for the cancellation of the voltage drop on the lines connecting the MAX6126 and the load. When using the Kelvin connection made possible by the independent current and voltage connections, take the power connection to the load from OUTF, and bring a line from OUTS to join the line from OUTF, at the point where the voltage accuracy is needed. The MAX6126 has the same type of Kelvin connection to cancel drops in the ground return line. Connect the load to ground and bring a connection from GNDS to exactly the same point.



**Applications Information**

**Precision Current Source**

Figure 2 shows a typical circuit providing a precision current source. The OUTF output provides the bias current for the bipolar transistor. OUTS and GNDS sense the voltage across the resistor and adjust the current sourced by OUTF accordingly. For even higher precision, use a MOSFET to eliminate base current errors.

The voltage range of OUTF is set by the reference output voltage (OUTS) and the  $V_{BE}$ (BJT) or  $V_{GS}$ (MOS) of the output external device:

$$V_{OUTF} = V_{BE} + V_{REF}$$

where:

$V_{OUTF}$  is voltage on OUTF pin

$V_{BE}$  is base-emitter drop across BJT

$V_{REF}$  is the actual voltage reference output this part is supposed to provide.

It translates to supply voltage requirement for voltage reference:

$$V_{IN} \geq V_{DROP} \text{ (dropout voltage)} + V_{BE_{max}} + V_{REF}$$

where:

$V_{DROP}$  is dropout voltage of voltage reference

**High-Resolution DAC and Reference from a Single Supply**

Figure 3 shows a typical circuit providing the reference for a high-resolution, 16-bit MAX541 D/A converter.

**Temperature Coefficient vs. Operating Temperature Range for a 1 LSB Maximum Error**

In a data converter application, the reference voltage of the converter must stay within a certain limit to keep the error in the data converter smaller than the resolution limit through the operating temperature range. Figure 4 shows the maximum allowable reference voltage temperature coefficient to keep the conversion error to less than 1 LSB, as a function of the operating temperature range ( $T_{MAX} - T_{MIN}$ ) with the converter resolution as a parameter. The graph assumes the reference voltage temperature coefficient as the only parameter affecting accuracy.

In reality, the absolute static accuracy of a data converter is dependent on the combination of many parameters such as integral nonlinearity, differential nonlinearity, offset error, gain error, as well as voltage reference changes

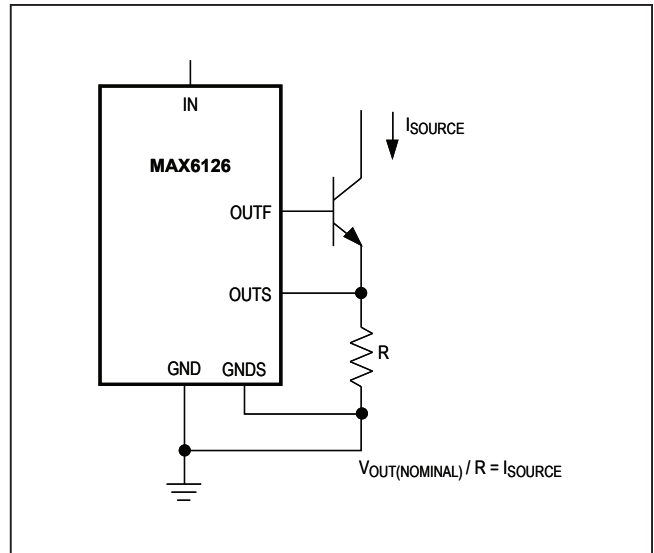

Figure 2. Precision Current Source

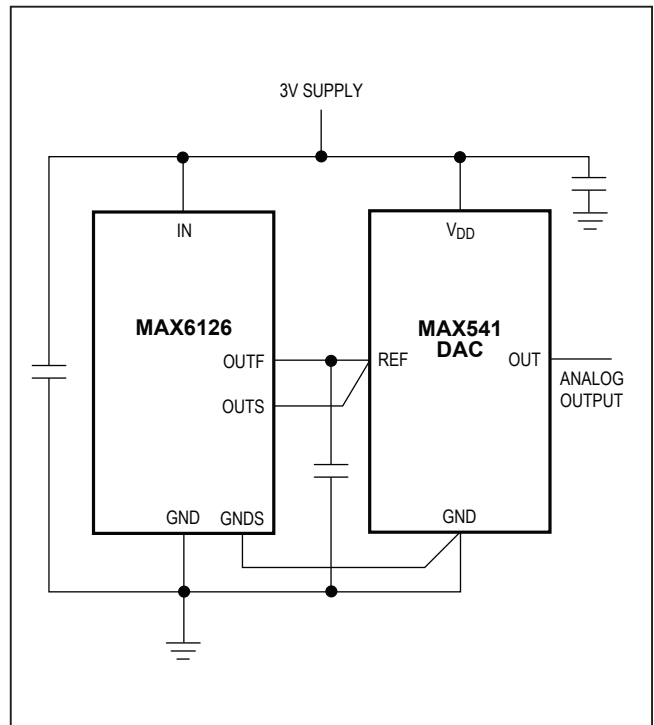

Figure 3. 14-Bit High-Resolution DAC and Positive Reference from a Single 3V Supply

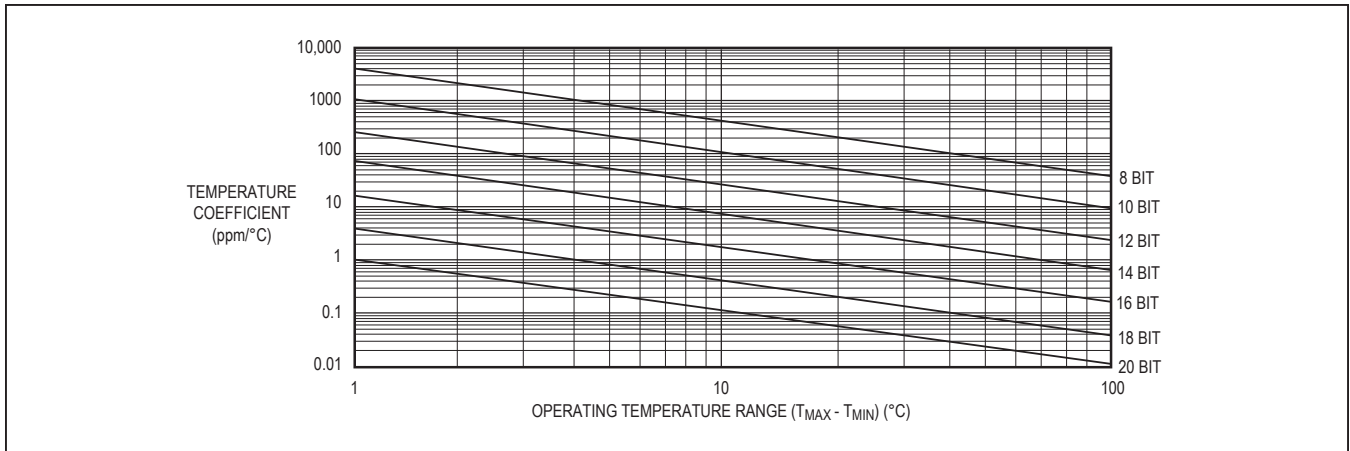

Figure 4. Temperature Coefficient vs. Operating Temperature Range for a 1 LSB Maximum Error

**Output Shifts and LTD after Standard IR Reflow and Mechanical Stress Effects (MAX6126AASA50+)**

There are many factors that contribute to a voltage reference’s drift over time. These can include part soldering to a board, package stress, board stress and layout, humidity and part-to-part variation. The extreme heat of an IR reflow can also cause the output voltage to shift since the materials that make up a semiconductor device and its package, have different rates of expansion and contraction. After a device going through any IR reflow profile or

a convection soldering oven, the reference voltage output shifts. The device’s expansion/contraction (due to the extreme heat/cooling process) applies stresses to the die which causes the output voltage to shift.

To better quantify the reference output shift due to die induced mechanical stress as a result of IR reflow as shown in Figure 5), Maxim has done two experiments:

**Experiment 1:** with 48 devices going through a 3x IR reflow process (without soldering down to a PCB)

**Experiment 2:** with 32 samples are undergone the same 3x IR reflow profile and soldered down to a PCB.

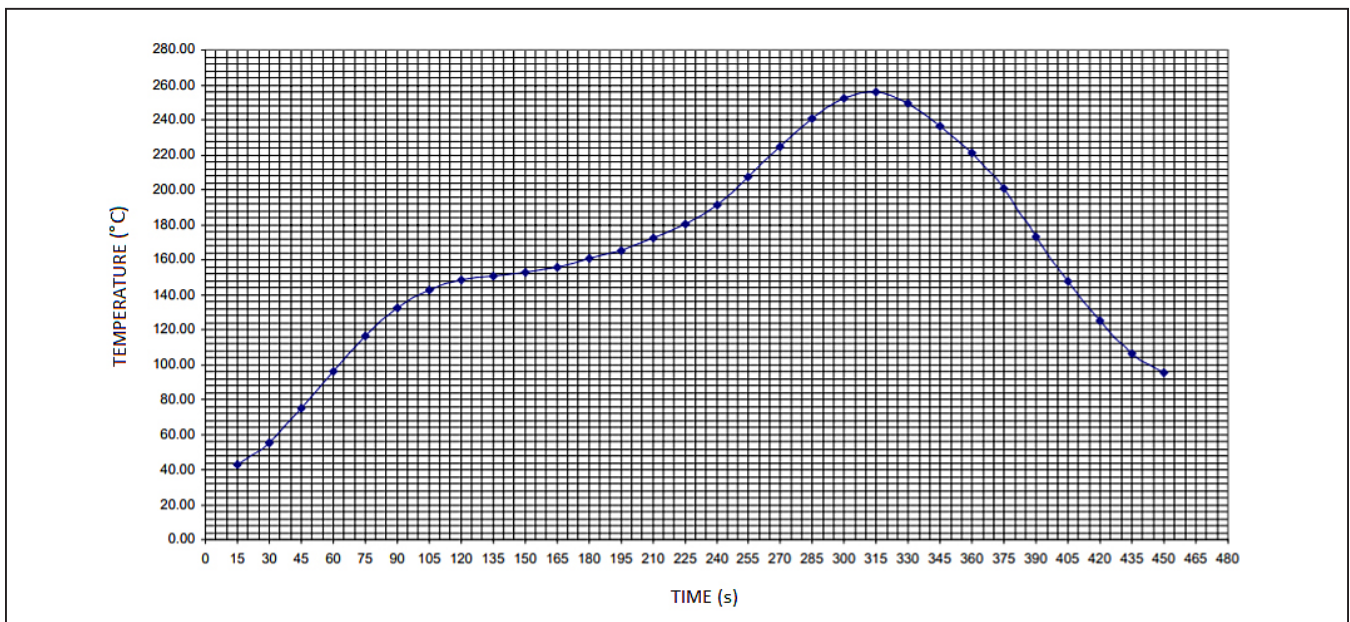

Figure 5. Standard IR Reflow Profile (Peak Temperature = 257°C, Ramping Rate = 0.802°C/s)

**First Experiment Results:**

Experimental results of the first experiment (undergone a 3x IR reflow without solder) are shown in [Figure 6](#), [7](#) and [8](#). [Figure 6a](#) shows the output voltage ( $V_{OUT}$ ) accuracy before the 3x IR reflow, [Figure 6b](#) presents the  $V_{OUT}$  accuracy after the 3x IR reflow and [Figure 6c](#) shows the

shift before and after the 3x IR reflow. [Figures 7a](#), [7b](#), and [7c](#) show the Tempco Pre, Post, and the Difference (Post-Pre) 3x IR reflow for the automotive temperature range respectively. Similarly, [Figures 8a](#), [8b](#), and [8c](#) plot the Tempco for the extended temperature range.

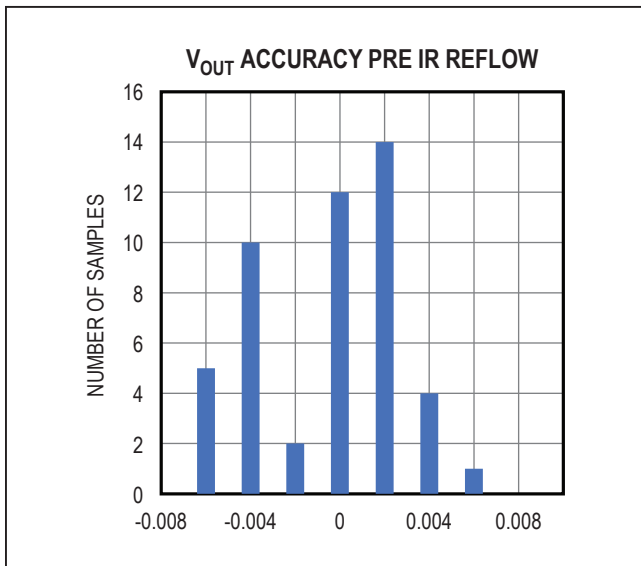

Figure 6a. 48 Samples  $V_{OUT}$  Accuracy Pre IR Reflow (%)

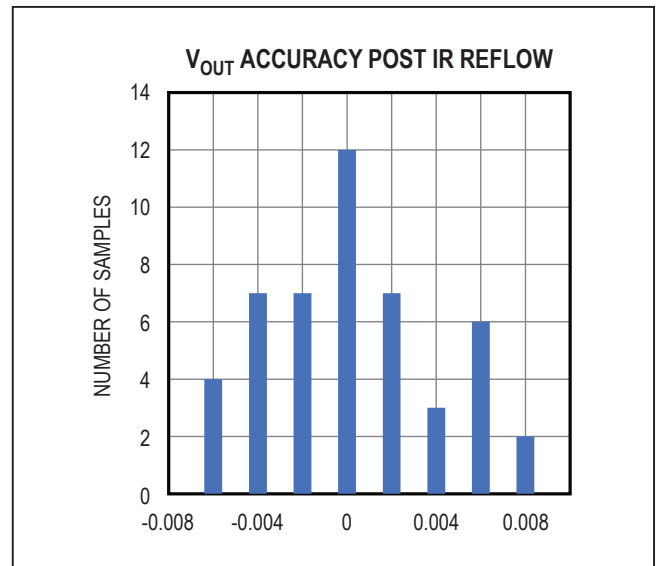

Figure 6b. 48 Samples  $V_{OUT}$  Accuracy Post IR Reflow (%)

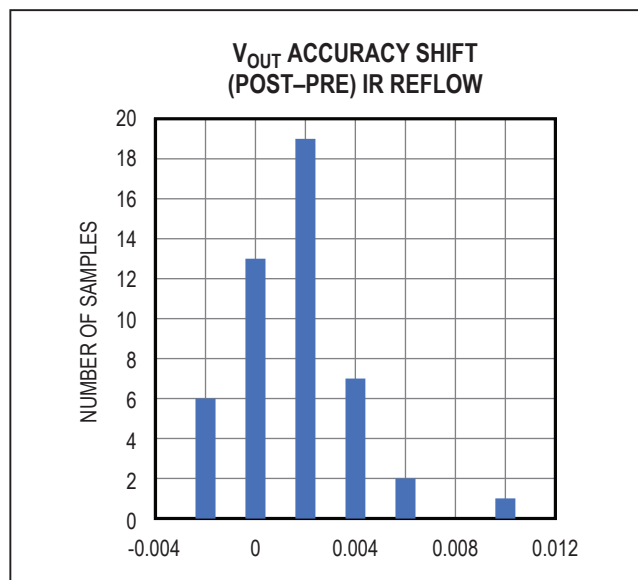

Figure 6c. 48 Samples  $V_{OUT}$  Accuracy Shift (Post-Pre) IR Reflow (%)

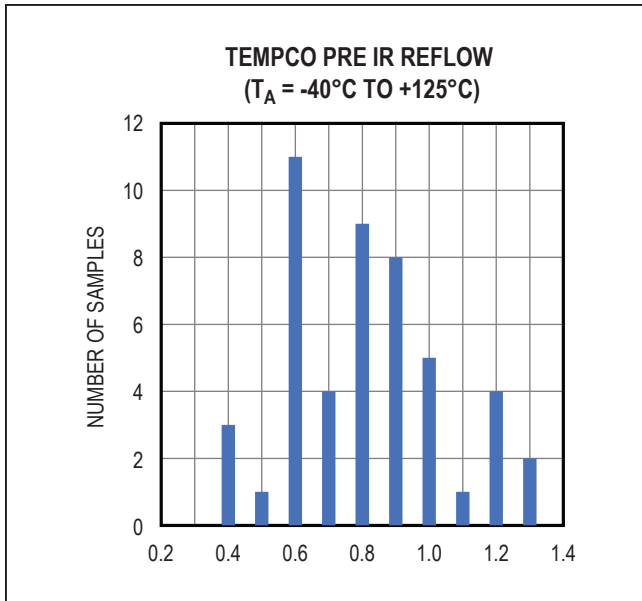

Figure 7a. 48 Samples Tempco Pre IR Reflow (ppm/°C)

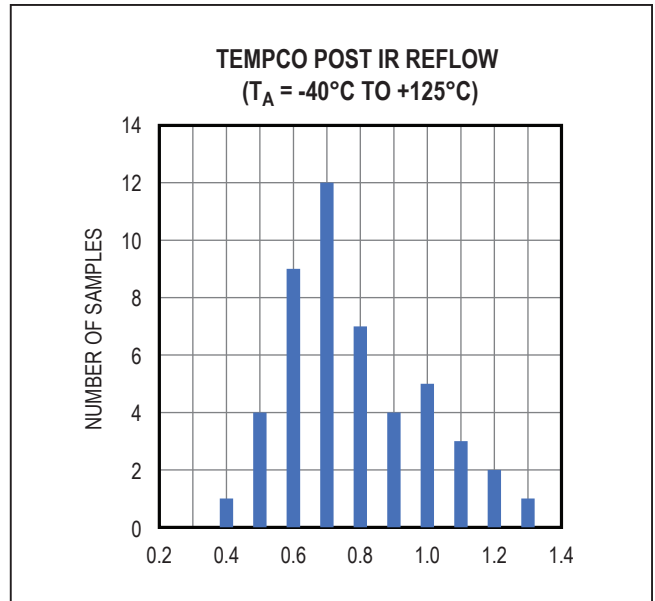

Figure 7b. 48 Samples Tempco Post IR Reflow (ppm/°C)

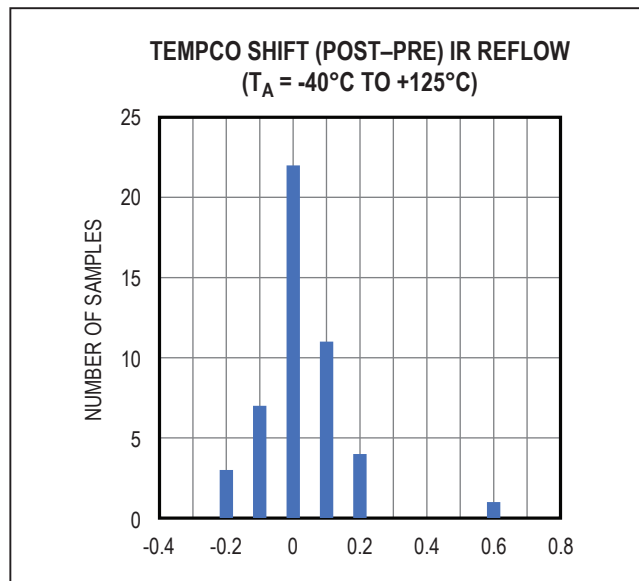

Figure 7c. 48 Samples Tempco Shift (Post-Pre) IR Reflow (ppm/°C)

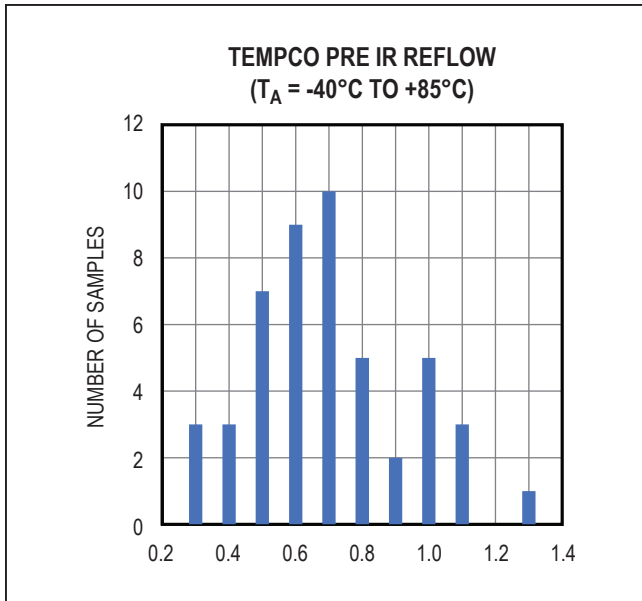

Figure 8a. 48 Samples Tempco Pre IR Reflow (ppm/°C)

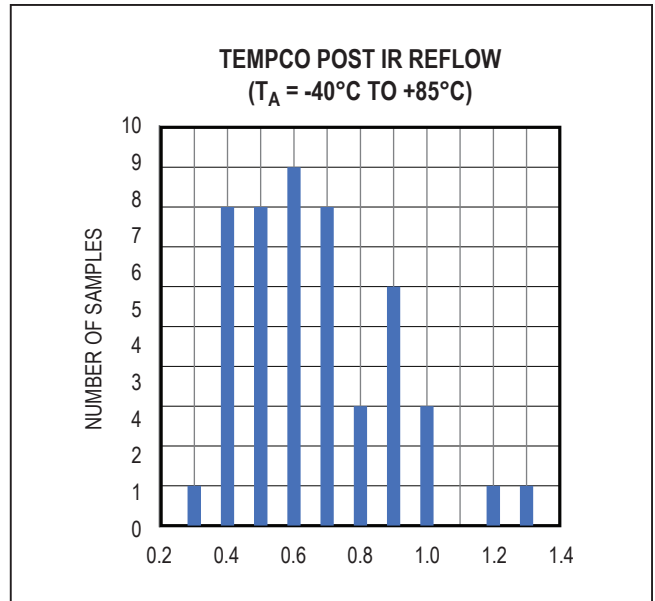

Figure 8b. 48 Samples Tempco Post IR Reflow (ppm/°C)

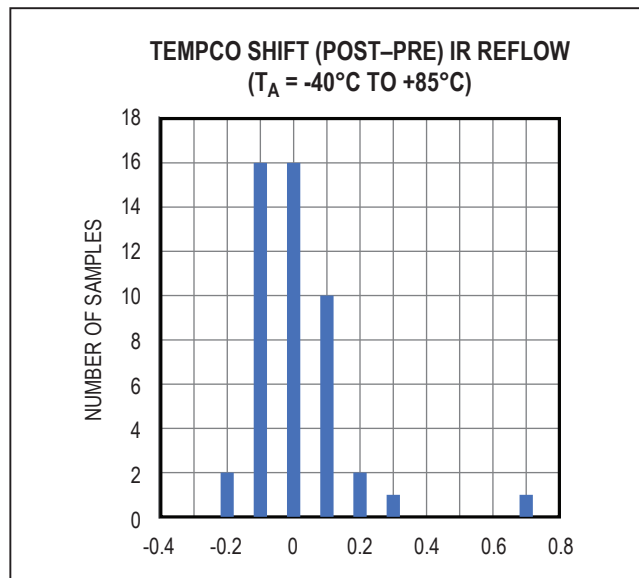

Figure 8c. 48 Samples Tempco Shift (Post-Pre) IR Reflow (ppm/°C)

**Second Experiment Results:**

In the second experiment, Maxim has evaluated a different batch of 32 samples before and after soldering down with the same 3x IR reflow profile. In this experiment, these samples underwent the effects of both 3x IR reflow and mechanical stress from soldering. The test board was set up in a humidity-controlled oven. Conditions were set to  $T_A = +35^\circ\text{C}$  and 40% relative humidity. Same as in experiment one, experimental data are presented in [Figures 9, 10 and 11](#).

We can observe that the MAX6126 output accuracy and temperature coefficient exhibit an additionally shift due to mechanical stress of PCB soldering compared to the first experiment where the MAX6126 was only exposed to the extreme heat of the IR reflow temperature cycle.

The above extra shift can be addressed with proper PCB design such that the mechanical stress induced by soldering is minimized.

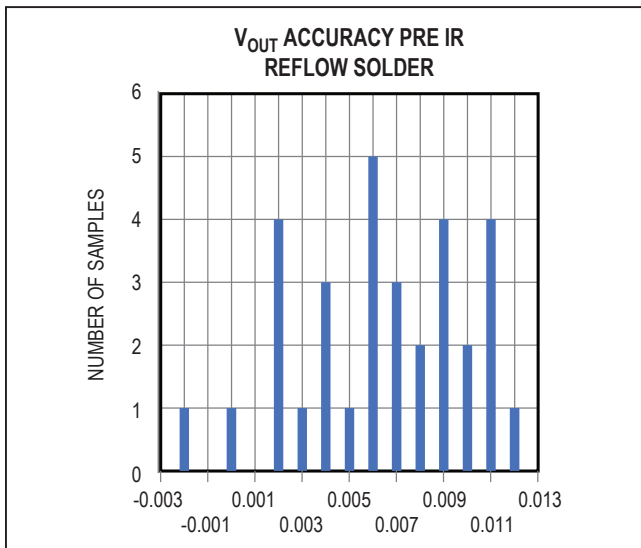

Figure 9a. 32 Samples Output Voltage Pre IR Reflow Solder (%)

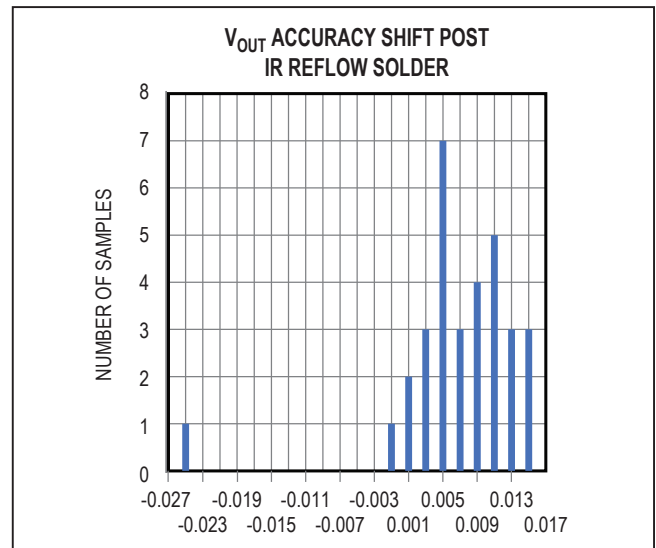

Figure 9b. 32 Samples Output Shift Post IR Reflow Solder (%)

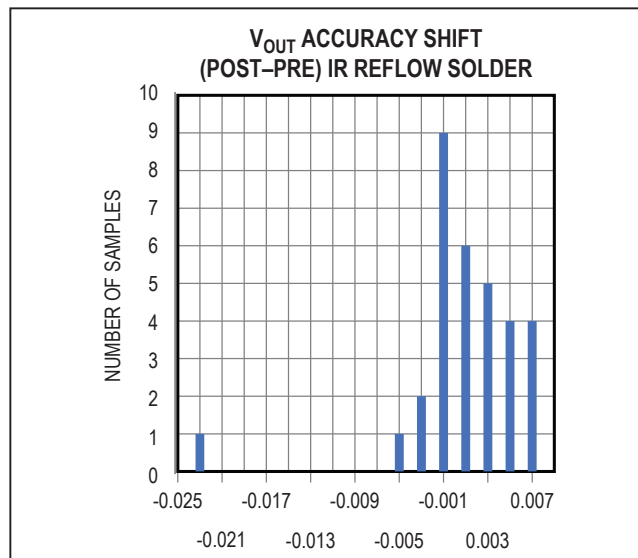

Figure 9c. 32 Samples Output Shift (Post-Pre) IR Reflow Solder (%)

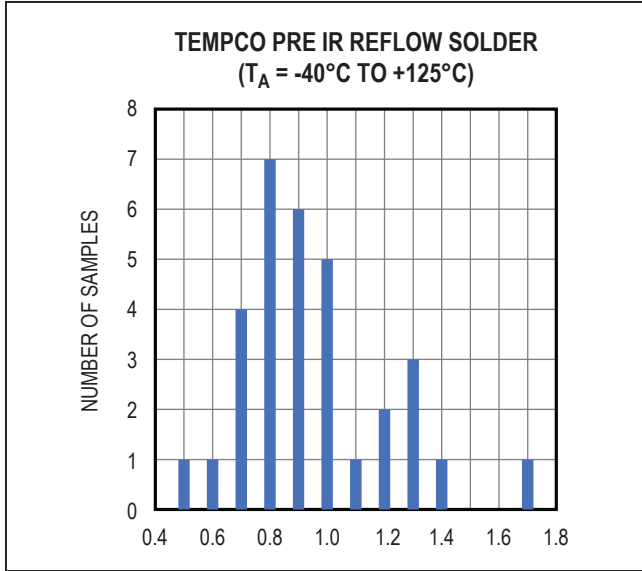

Figure 10a. 32 Samples Tempco Pre IR Reflow Solder (ppm/°C)

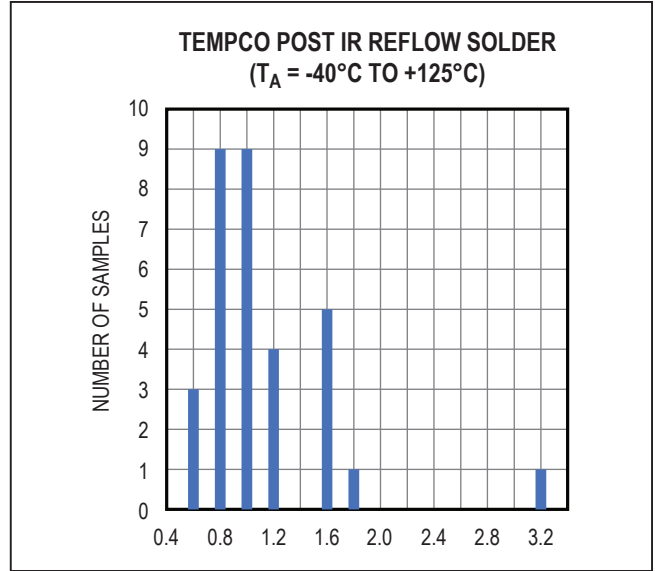

Figure 10b. 32 Samples Tempco Post IR Reflow Solder (ppm/°C)

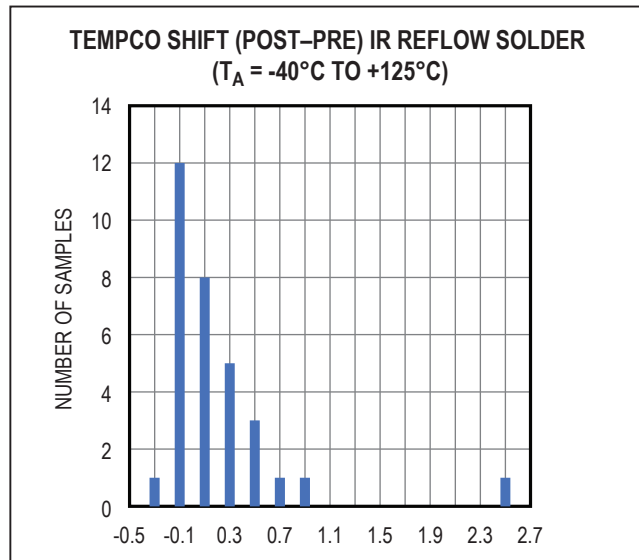

Figure 10c. 32 Samples Tempco Shift (Post-Pre) IR Reflow Solder (ppm/°C)

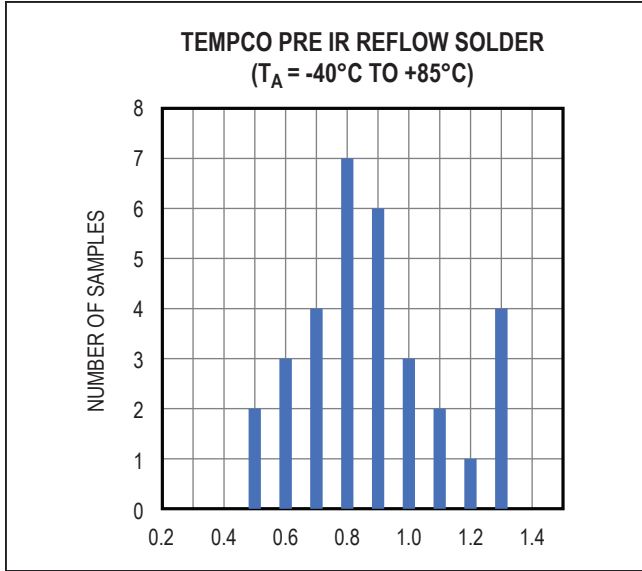

Figure 11a. 32 Samples Tempco Pre IR Reflow Solder (ppm/°C)

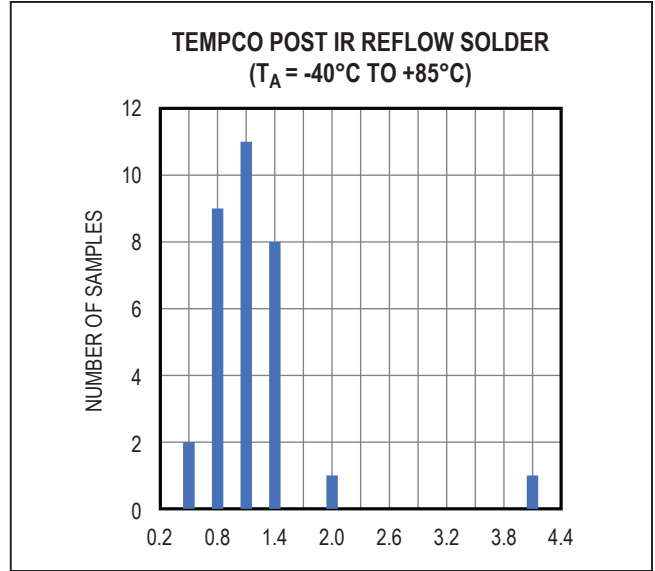

Figure 11b. 32 Samples Tempco Post IR Reflow Solder (ppm/°C)

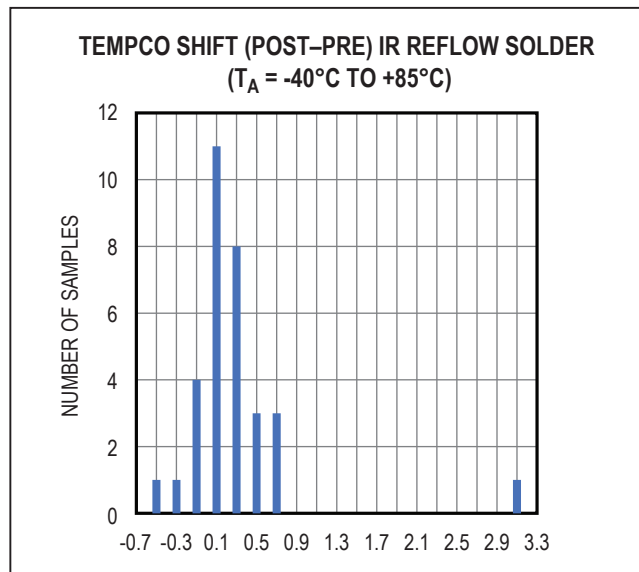

Figure 11c. 32 Samples Tempco Shift (Post-Pre) IR Reflow Solder (ppm/°C)



**Long Term Drift (LTD)**

Besides showing the output voltage shifts due to reflows and mechanical stresses, Maxim has also collected the long-term drift of these 32 MAX6126 units in another run more than 1000 hours after the devices have gone through 3x reflow and eventually soldered down on a PCB. Similar

to the experiment above, the test board was set up in a humidity and temperature controlled oven. The conditions were set to  $T_A = +35^\circ\text{C}$  and 40% relative humidity (red trace as shown in [Figure 12](#)). The LTD result as shown in [Figure 12](#).

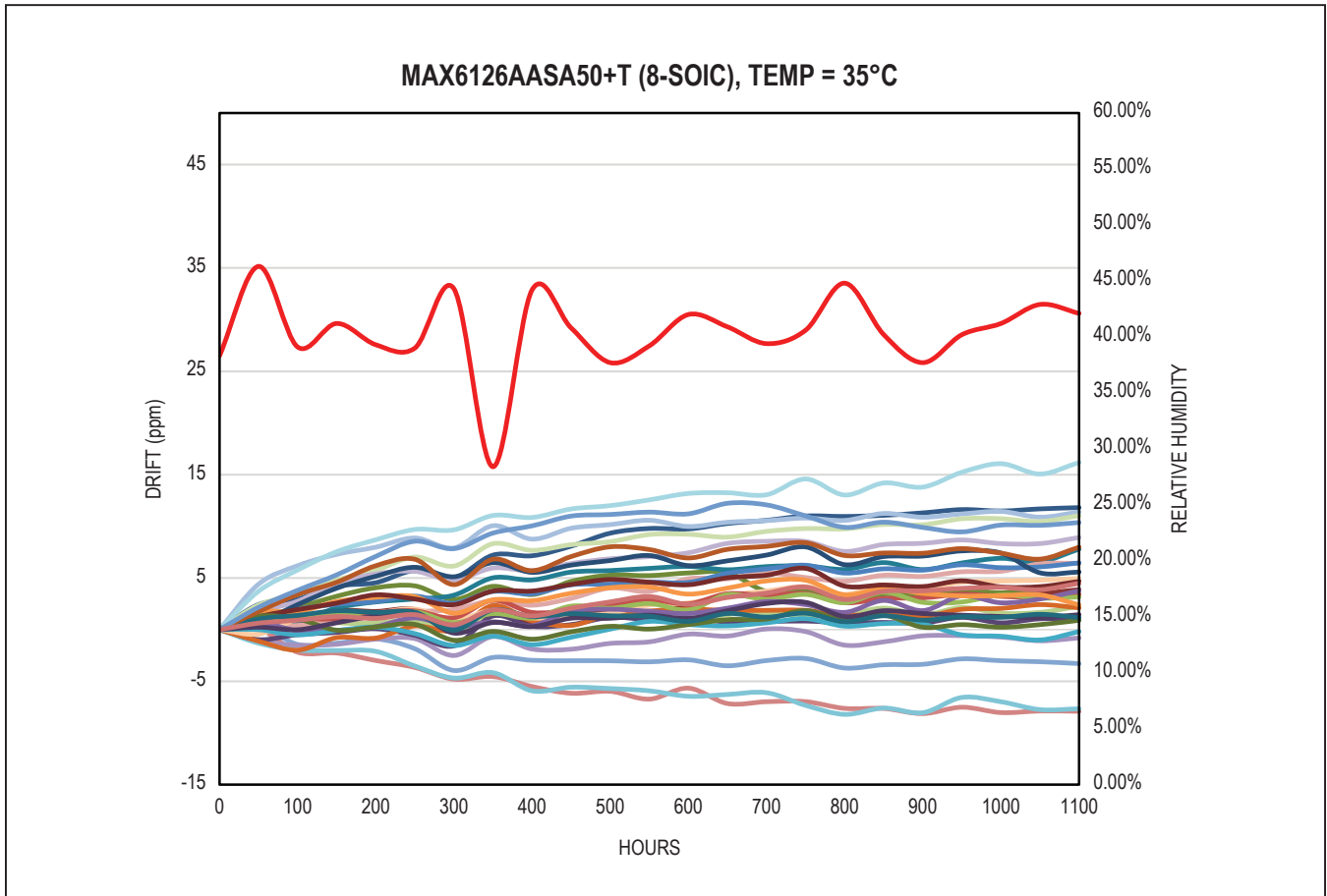
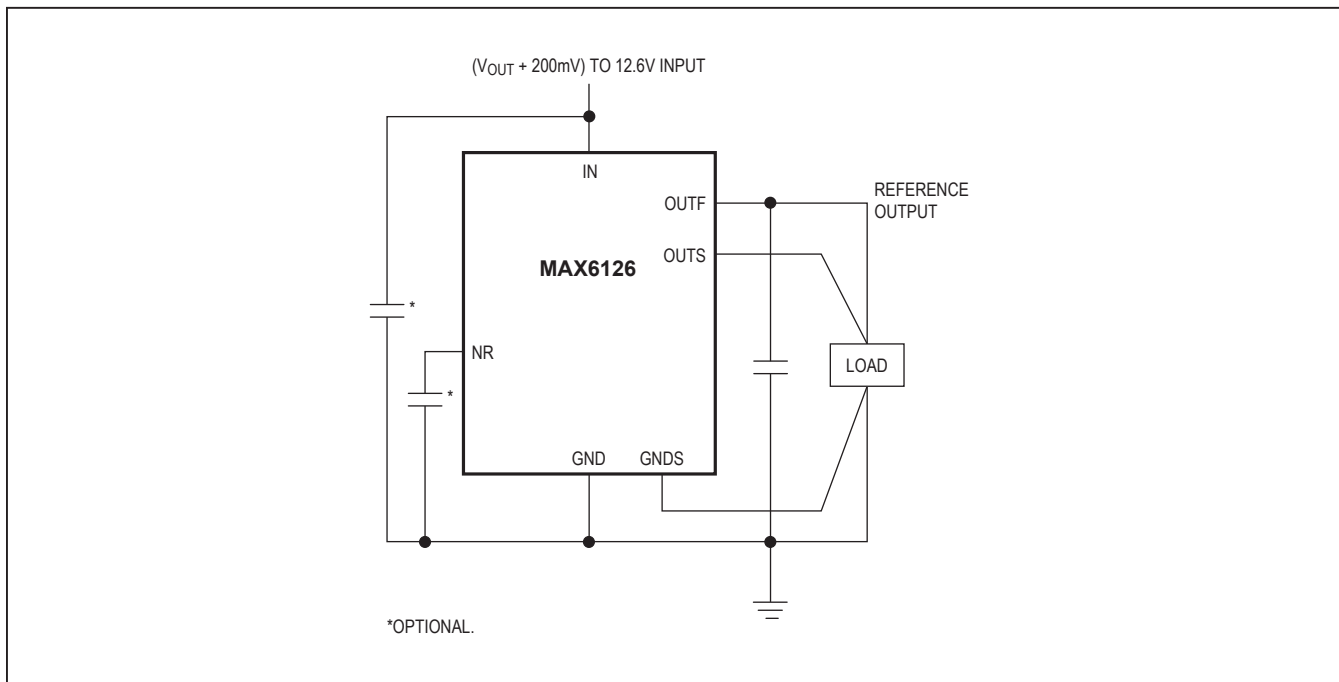

Figure 12. MAX6126 AASA50+ LTD after 3x Reflow and being Soldered Down.

Typical Operating Circuit



Chip Information

PROCESS: BICMOS

## Ordering Information (continued)

| PART             | TEMP RANGE      | PIN-PACKAGE | OUTPUT VOLTAGE (V) | MAXIMUM INITIAL ACCURACY (%) | MAXIMUM TEMPCO (-40°C to +85°C) (ppm/°C) |
|------------------|-----------------|-------------|--------------------|------------------------------|--|
| MAX6126B21+      | -40°C to +125°C | 8 $\mu$ MAX | 2.048              | 0.1                          | 7  |
| MAX6126AASA25+   | -40°C to +125°C | 8 SO        | 2.500              | 0.02                         | 3  |
| MAX6126BASA25+   | -40°C to +125°C | 8 SO        | 2.500              | 0.06                         | 5  |
| MAX6126A25+      | -40°C to +125°C | 8 $\mu$ MAX | 2.500              | 0.06                         | 3  |
| MAX6126B25+      | -40°C to +125°C | 8 $\mu$ MAX | 2.500              | 0.1                          | 7  |
| MAX6126A28+      | -40°C to +125°C | 8 $\mu$ MAX | 2.800              | 0.06                         | 3  |
| MAX6126B28+      | -40°C to +125°C | 8 $\mu$ MAX | 2.800              | 0.1                          | 7  |
| MAX6126AASA30+   | -40°C to +125°C | 8 SO        | 3.000              | 0.02                         | 3  |
| MAX6126BASA30+   | -40°C to +125°C | 8 SO        | 3.000              | 0.06                         | 5  |
| MAX6126A30+      | -40°C to +125°C | 8 $\mu$ MAX | 3.000              | 0.06                         | 3  |
| MAX6126B30+      | -40°C to +125°C | 8 $\mu$ MAX | 3.000              | 0.1                          | 7  |
| MAX6126AASA33+   | -40°C to +125°C | 8 SO        | 3.300              | 0.02                         | 3  |
| MAX6126BASA33+   | -40°C to +125°C | 8 SO        | 3.300              | 0.06                         | 5  |
| MAX6126A33+      | -40°C to +125°C | 8 $\mu$ MAX | 3.300              | 0.06                         | 3  |
| MAX6126B33+      | -40°C to +125°C | 8 $\mu$ MAX | 3.300              | 0.1                          | 7  |
| MAX6126AASA36+   | -40°C to +125°C | 8 SO        | 3.600              | 0.02                         | 3  |
| MAX6126BASA36+   | -40°C to +125°C | 8 SO        | 3.600              | 0.06                         | 5  |
| MAX6126A36+      | -40°C to +125°C | 8 $\mu$ MAX | 3.600              | 0.06                         | 3  |
| MAX6126B36+      | -40°C to +125°C | 8 $\mu$ MAX | 3.600              | 0.1                          | 7  |
| MAX6126AASA41+   | -40°C to +125°C | 8 SO        | 4.096              | 0.02                         | 3  |
| MAX6126BASA41+   | -40°C to +125°C | 8 SO        | 4.096              | 0.06                         | 5  |
| MAX6126BASA41/V+ | -40°C to +125°C | 8 SO        | 4.096              | 0.06                         | 5  |
| MAX6126A41+      | -40°C to +125°C | 8 $\mu$ MAX | 4.096              | 0.06                         | 3  |
| MAX6126B41+      | -40°C to +125°C | 8 $\mu$ MAX | 4.096              | 0.1                          | 7  |
| MAX6126AASA50+   | -40°C to +125°C | 8 SO        | 5.000              | 0.02                         | 3  |
| MAX6126BASA50+   | -40°C to +125°C | 8 SO        | 5.000              | 0.06                         | 5  |
| MAX6126A50+      | -40°C to +125°C | 8 $\mu$ MAX | 5.000              | 0.06                         | 3  |
| MAX6126B50+      | -40°C to +125°C | 8 $\mu$ MAX | 5.000              | 0.1                          | 7  |

+Denotes a lead(Pb)-free/RoHS-compliant package.

/V denotes an automotive qualified part.

## Package Information

For the latest package outline information and land patterns (footprints), go to [www.maximintegrated.com/packages](http://www.maximintegrated.com/packages). Note that a "+", "#", or "-" in the package code indicates RoHS status only. Package drawings may show a different suffix character, but the drawing pertains to the package regardless of RoHS status.

| PACKAGE TYPE | PACKAGE CODE | OUTLINE NO.             | LAND PATTERN NO.        |
|--------------|--------------|-------------------------|-------------------------|
| 8 $\mu$ MAX  | U8+1         | <a href="#">21-0036</a> | <a href="#">90-0092</a> |
| 8 SO         | S8+4         | <a href="#">21-0041</a> | <a href="#">90-0096</a> |

## Revision History

| REVISION NUMBER | REVISION DATE | DESCRIPTION   | PAGES CHANGED   |
|-----------------|---------------|---|-----------------|
| 0               | 10/02         | Initial release   | —               |
| 1               | 3/03          | Remove “future product” and “contact factory” notes   | 1, 16           |
| 2               | 6/03          | Add “A” grade devices   | 1, 16           |
| 3               | 12/03         | Change $\mu$ MAX part number  | 1, 16           |
| 4               | 7/04          | Add top mark to <i>Ordering Information</i>   | 1, 16           |
| 5               | 12/10         | Add 2.8V option, add lead-free options, update <i>Package Information</i>   | 1, 2, 4, 15, 16 |
| 6               | 8/12          | Added automotive package, MAX6126BASA41/V+ to data sheet  | 17              |
| 7               | 4/16          | Updated <i>Typical Operating Characteristics</i> section (added TOC15)  | 14, 15          |
| 8               | 6/16          | Added <i>Electrical Characteristics</i> tables, text references, and <i>Ordering Information</i> references for 3.3V and 3.6V output options. | 1, 6, 9–13, 17  |
| 9               | 9/19          | Added Output Shifts and LTD after Standard IR Reflow and <i>Mechanical Stress Effects (MAX6126AASA50+)</i> section                            | 18–26           |

For pricing, delivery, and ordering information, please visit Maxim Integrated's online storefront at <https://www.maximintegrated.com/en/storefront/storefront.html>.

Maxim Integrated cannot assume responsibility for use of any circuitry other than circuitry entirely embodied in a Maxim Integrated product. No circuit patent licenses are implied. Maxim Integrated reserves the right to change the circuitry and specifications without notice at any time. The parametric values (min and max limits) shown in the *Electrical Characteristics* table are guaranteed. Other parametric values quoted in this data sheet are provided for guidance.