

TGS2351-SM

DC – 6 GHz High Power SPDT Switch

Applications

- High Power Switching

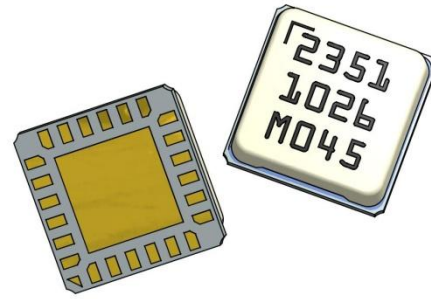

QFN 4x4mm 24L

Product Features

- Frequency Range: DC – 6 GHz
- Power Handling: up to 40 W
- Insertion Loss: < 1 dB
- Isolation: -40 dB typical
- Switching Speed: 50 ns
- Control Voltages: 0 V/-40 V
- Dimensions: 4.0 x 4.0 x 1.43 mm

Functional Block Diagram

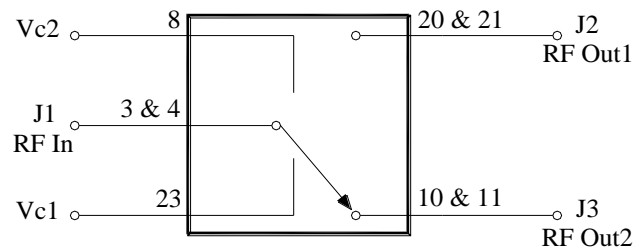

General Description

The TriQuint TGS2351-SM is a Single-Pole, Double-Throw (SPDT) Packaged Switch. The TGS2351-SM operates from DC to 6 GHz and is designed using TriQuint's 0.25um GaN on SiC production process.

The TGS2351-SM typically provides up to 40 W input power handling at control voltages of 0/-40 V. This switch maintains low insertion loss < 1 dB, and high isolation -40 dB typical.

The TGS2351-SM is ideally suited for High Power Switching application.

Lead-free and RoHS compliant

Evaluation Boards are available upon request.

Pin Configuration

Pin #	Symbol
1, 2, 5, 6, 7, 9, 12, 13, 18, 19, 22, 24, 25	GND
3 and 4	RF In
8	Vc2
10 and 11	RF Out2
14, 15, 16, 17	N/C
20 and 21	RF Out1
23	Vc1

Ordering Information

Part No.	ECCN	Description
TGS2351-SM	EAR99	DC – 6 GHz High Power SPDT Switch

TGS2351-SM

DC – 6 GHz High Power SPDT Switch



Specifications

Absolute Maximum Ratings

Parameter	Rating
Control Voltage, Vc	- 50 V
Control Current, Ic	-1 to 7.8 mA
Power Dissipation, Pdiss	10 W
RF Input Power, CW, 50Ω, T = 25°C	47 dBm
RF Input Power, Hot Switching, 50% switching Duty Cycle	40 dBm
Channel Temperature, Tch	275 °C
Mounting Temperature (30 Seconds)	260 °C
Storage Temperature	-55 to 150 °C

Operation of this device outside the parameter ranges given above may cause permanent damage. These are stress ratings only, and functional operation of the device at these conditions is not implied.

Recommended Operating Conditions

Parameter	Min	Typical	Max	Units
Vc1		-40 / 0		V
Vc2		0 / -40		V
Ic1 / Ic2		-0.4 to 0.1		mA

Electrical specifications are measured at specified test conditions. Specifications are not guaranteed over all recommended operating conditions.

Electrical Specifications

Test conditions unless otherwise noted: 25°C, Vc1 = -40/0 V, Vc2 = 0/-40 V, see Function Table at Application Circuit on page 7

Parameter	Min	Typical	Max	Units
Operational Frequency Range	DC		6	GHz
Control Current (Ic1/ Ic2)	-1		0.1	mA
Insertion Loss (On-State): DC to 5 GHz		0.5	1	dB
Insertion Loss (On-State): 6 GHz		0.8	1.2	
Input Return Loss – On-State (Common Port RL)	12	20		dB
Output Return Loss – On-State (Switched Port RL)	12	20		dB
Isolation (Off-State)		-40	-31	dB
Output Return Loss – Off-Sate (Isolated Port RL)		2.5		dB
Input Power ^{1/}		46		dBm
Output Power @ Pin = 46dBm, 1-6GHz		45		dBm
Insertion Loss Temperature Coefficient		-0.003		dB/°C
Output TOI @ Pin = 23 dBm		50		dBm
Switching Speed – On ^{2/}		50		ns
Switching Speed – Off ^{2/}		50		ns

1/ The Input Power will be reduced if < 10 MHz.

2/ These Switching Speed dependent on Switch Driver circuit to deliver Vc = 0/-40 V. The rise and fall time of the Switch Driver which was used to perform for this data is 35 ns, as shown on page 6. For further technical information, see [GaN SPDT Switch Drivers Application Note](#)

Specifications (cont.)

Thermal and Reliability Information

Parameter	Condition	Rating
Thermal Resistance, θ_{JC} , measured to back of package	Tbase = 85 °C	$\theta_{JC} = 6.1$ °C/W
Channel Temperature (Tch), and Median Lifetime (Tm)	Tbase = 85 °C, Vc1 = 0 V, Vc2 = -40 V, Pin = 40 W, Pdiss = 5.3 W	Tch = 118 °C Tm = 1.4 E+9 Hours

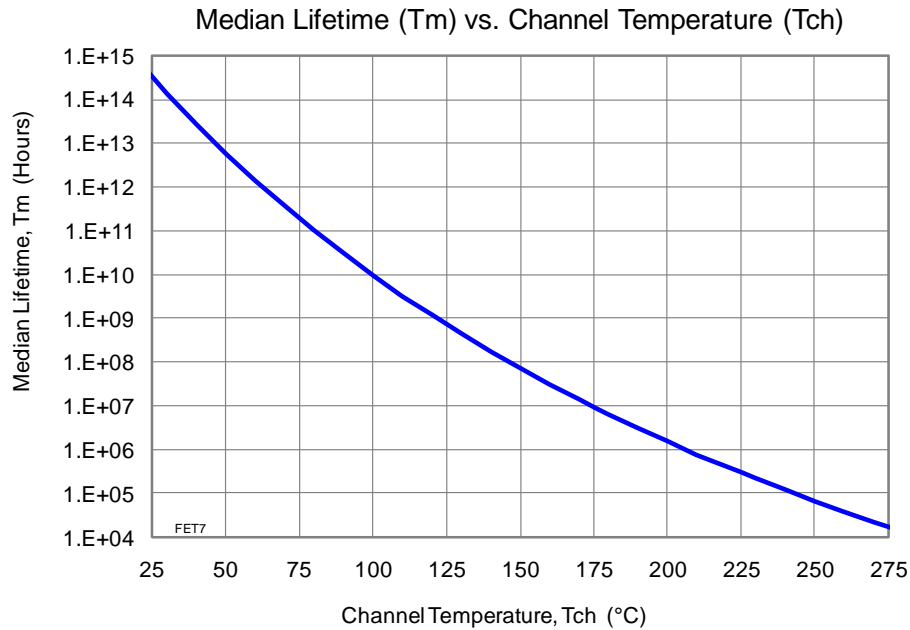

TGS2351-SM

DC – 6 GHz High Power SPDT Switch



Typical Performance

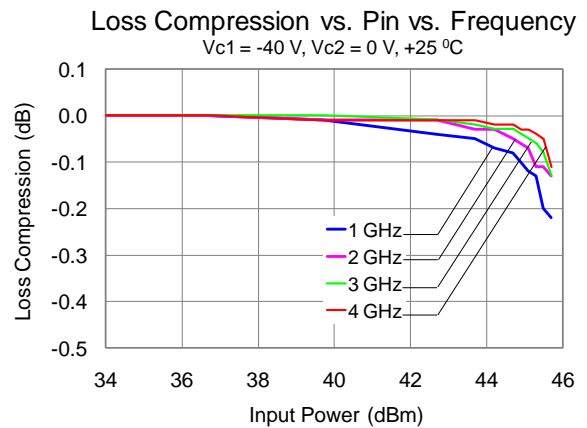
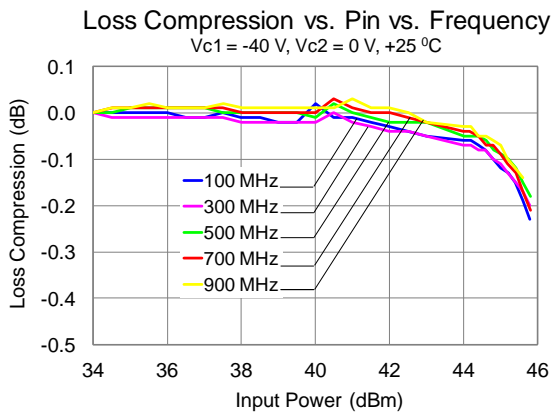
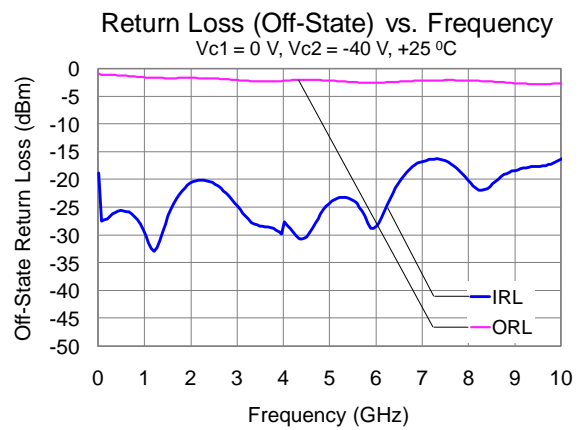
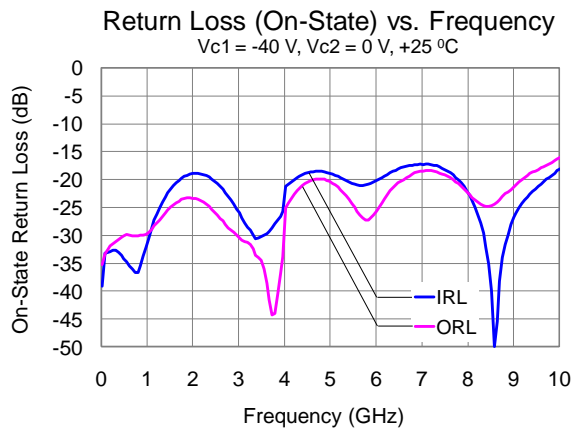
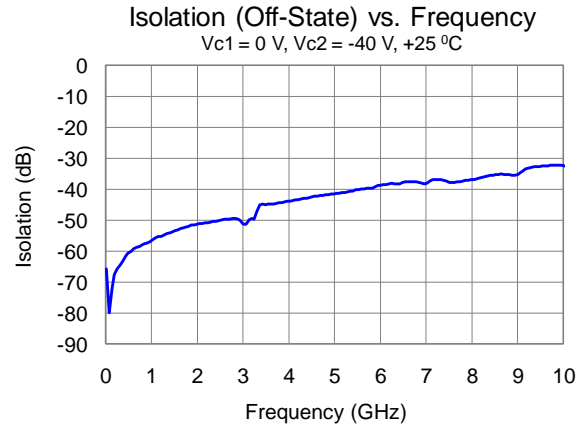
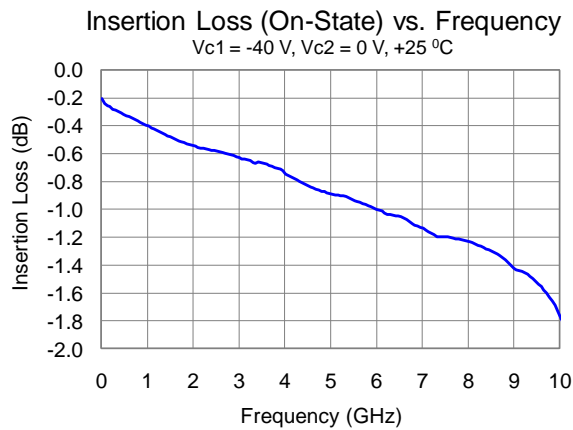

TGS2351-SM

DC – 6 GHz High Power SPDT Switch



Typical Performance (cont.)

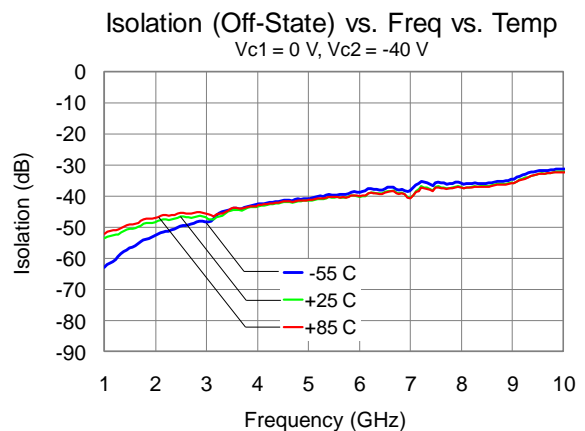
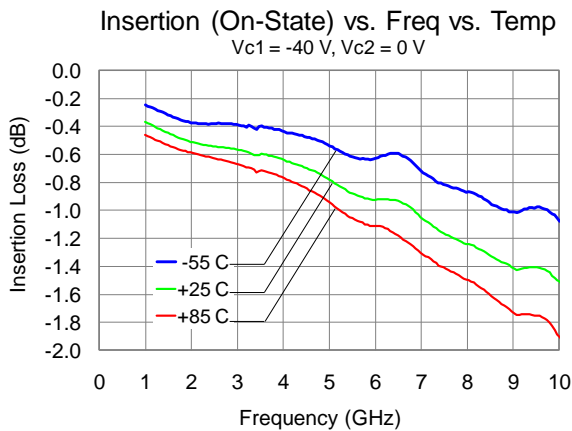
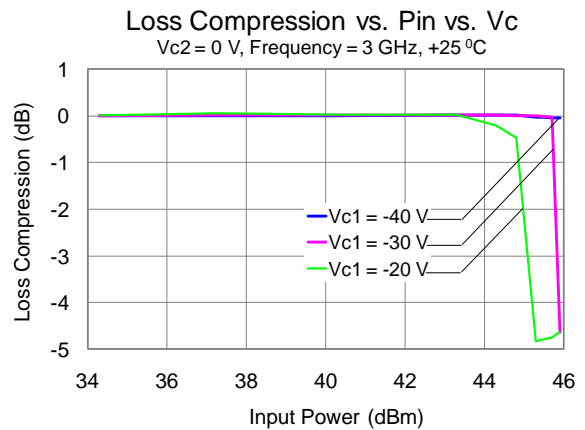
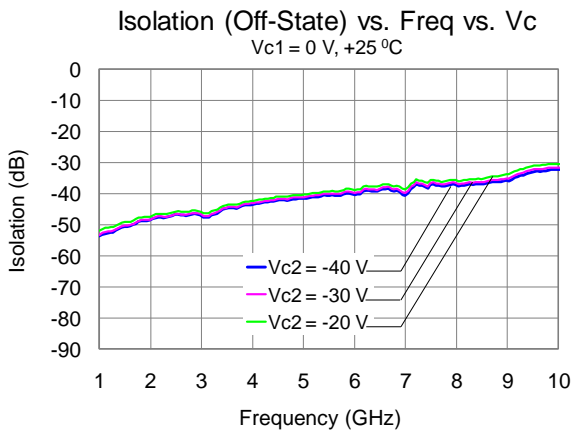
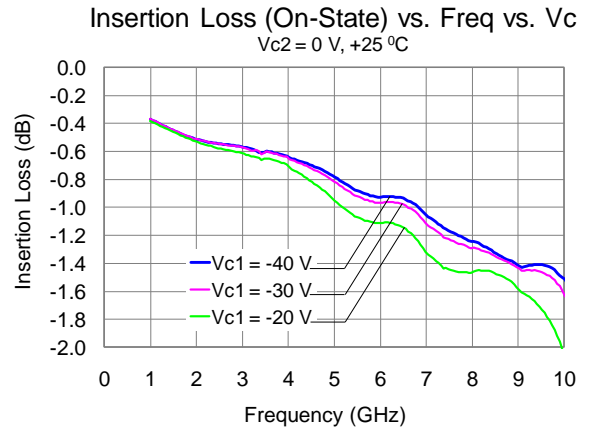
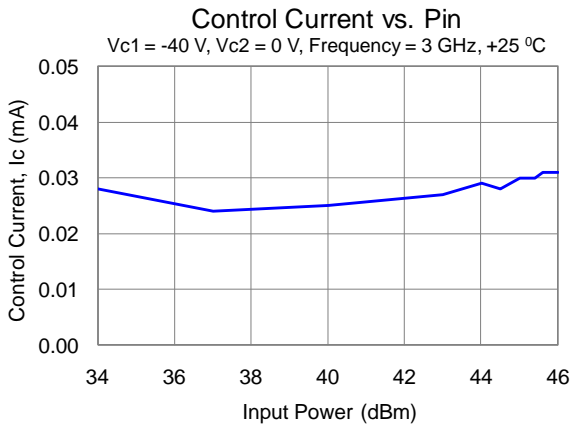

TGS2351-SM

DC – 6 GHz High Power SPDT Switch



Typical Performance (cont.)

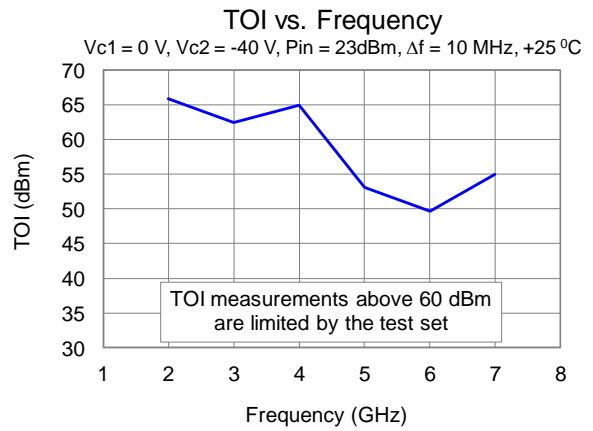
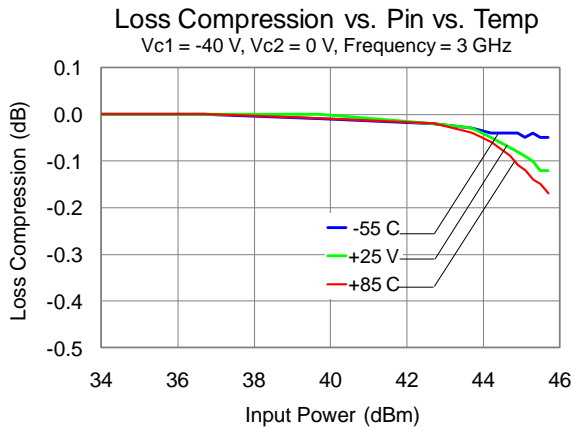

Switching Speed – On 50 ns
 Vc = 0/-40 V, Freq = 3 GHz, Pin = 30 dBm, +25 °C

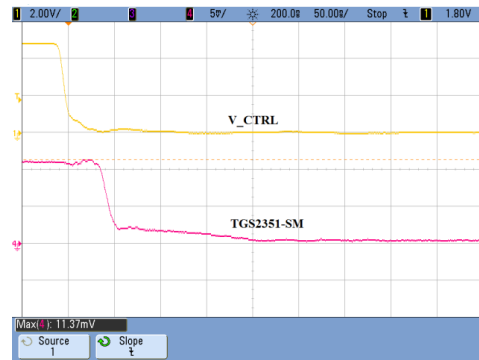

Switching Speed - Off 50 ns
 Vc = 0/-40 V, Freq = 3 GHz, Pin = 30 dBm, +25 °C

TGS2351-SM

DC – 6 GHz High Power SPDT Switch

Application Circuit

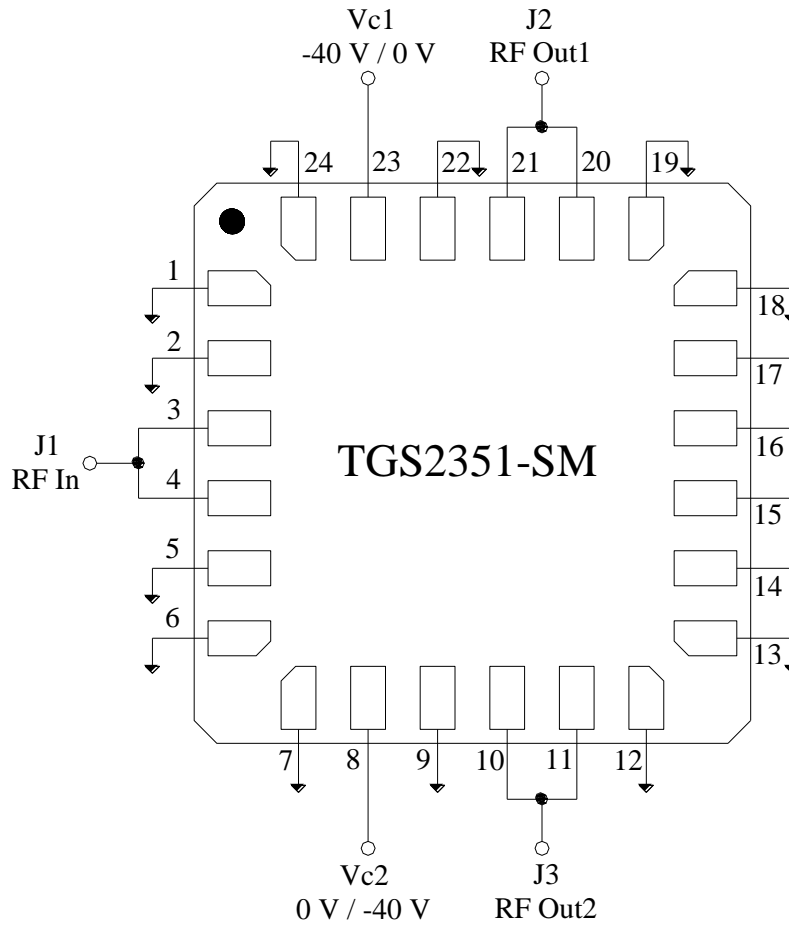

This switch can be configured as a Single Pole, Single Throw (SPST) by terminating one unused RF Out port with a 50 Ohm load.

Bias-up Procedure	Bias-down Procedure
Vc1 or Vc2 set to -40 V (see Function Table below for RF Path)	Turn off RF supply
Vc2 or Vc1 set to 0 V (see Function Table below for RF Path)	Turn Vc1 or Vc2 to 0V
Apply RF signal to RF Input	Turn Vc2 or Vc1 to 0 V

Function Table

RF Path	State	Vc1	Vc2
RF In to RF Out1 (50 Ohm load to RF Out2)	On-State (Insertion Loss)	0 V	-40 V
	Off-State (Isolation)	-40 V	0 V
RF In to RF Out2 (50 Ohm load to RF Out1)	On-State (Insertion Loss)	-40 V	0 V
	Off-State (Isolation)	0 V	-40 V

TGS2351-SM

DC – 6 GHz High Power SPDT Switch

Pin Description

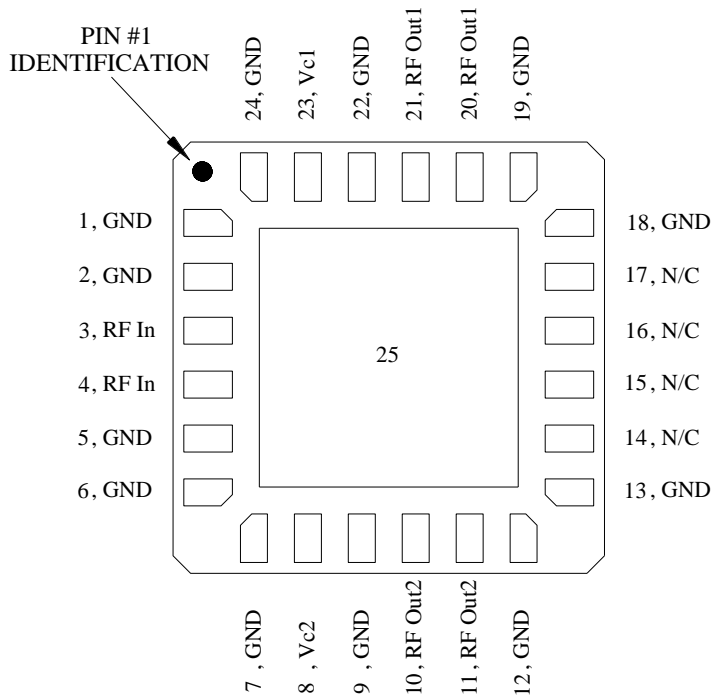

Pin	Symbol	Description
1, 2, 5, 6, 7, 9, 12, 13, 18, 19, 22, and 24	GND	No internal connection; must be grounded on PCB
3 and 4	RF In	Input, matched to 50 ohms, DC coupled
9, 22	GND	Connected to GND paddle (pin 25) must be grounded on PCB to improve isolation
8	Vc2	Control voltage #2; see Application Circuit on page 7 as an example
10 and 11	RF Out2	Output #2, matched to 50 ohms, DC coupled
14, 15, 16, and 17	N/C	No internal connection; can be grounded or left open
20 and 21	RF Out1	Output #1, matched to 50 ohms, DC coupled
23	Vc1	Control voltage #1; see Application Circuit on page 7 as an example
25	GND	Backside Paddle. Multiple vias should be employed to minimize inductance and thermal resistance; see Mounting Configuration on page 11 for suggested footprint.

TGS2351-SM

DC – 6 GHz High Power SPDT Switch

Applications Information

PC Board Layout

Top RF layer is 0.010” thick Rogers 4350, $\epsilon_r = 3.66$. Metal layers are 0.5-oz copper. Microstrip 50 Ω line detail: width = 0.0217”.

The pad pattern shown has been developed and tested for optimized assembly at TriQuint Semiconductor. The PCB land pattern has been developed to accommodate lead and package tolerances. Since surface mount processes vary from company to company, careful process development is recommended.

For further technical information, refer to the [TGS2351-SM](#) Product Information page.

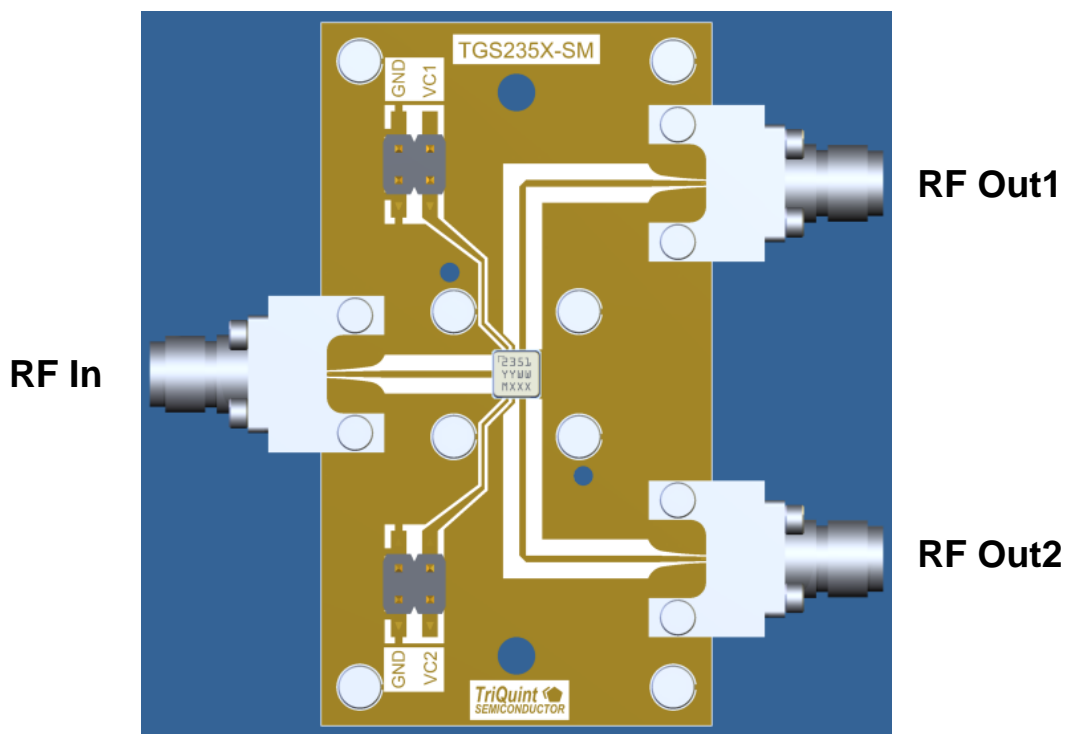

TGS2351-SM

DC – 6 GHz High Power SPDT Switch

Mechanical Information (cont.)

Mounting Configuration

All dimensions are in millimeters (inches).

Notes:

1. A heatsink underneath the area of the PCB for the mounted device is recommended for proper thermal operation.
2. Ground / thermal vias are critical for the proper performance of this device.
Vias have a final plated thru diameter of .203 mm (.008”).

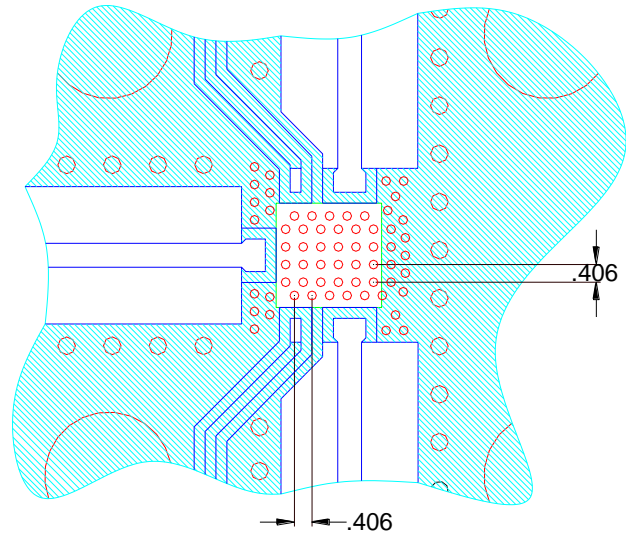

Product Compliance Information

ESD Information



Caution! ESD-Sensitive Device

ESD Rating: Class 1B
 Value: Passes ≥ 500 V min.
 Test: Human Body Model (HBM)
 Standard: JEDEC Standard JESD22-A114

MSL Rating

Level 1 at +260 °C convection reflow
 The part is rated Moisture Sensitivity Level TBD at 260°C per JEDEC standard IPC/JEDEC J-STD-020.

ECCN

US Department of Commerce EAR99

Solderability

Compatible with the latest version of J-STD-020, Lead free solder, 260°

This part is compliant with EU 2002/95/EC RoHS directive (Restrictions on the Use of Certain Hazardous Substances in Electrical and Electronic Equipment).

This product also has the following attributes:

- Lead Free
- Halogen Free (Chlorine, Bromine)
- Antimony Free
- TBBP-A (C₁₅H₁₂Br₄O₂) Free
- PFOS Free
- SVHC Free

Recommended Soldering Temperature Profile

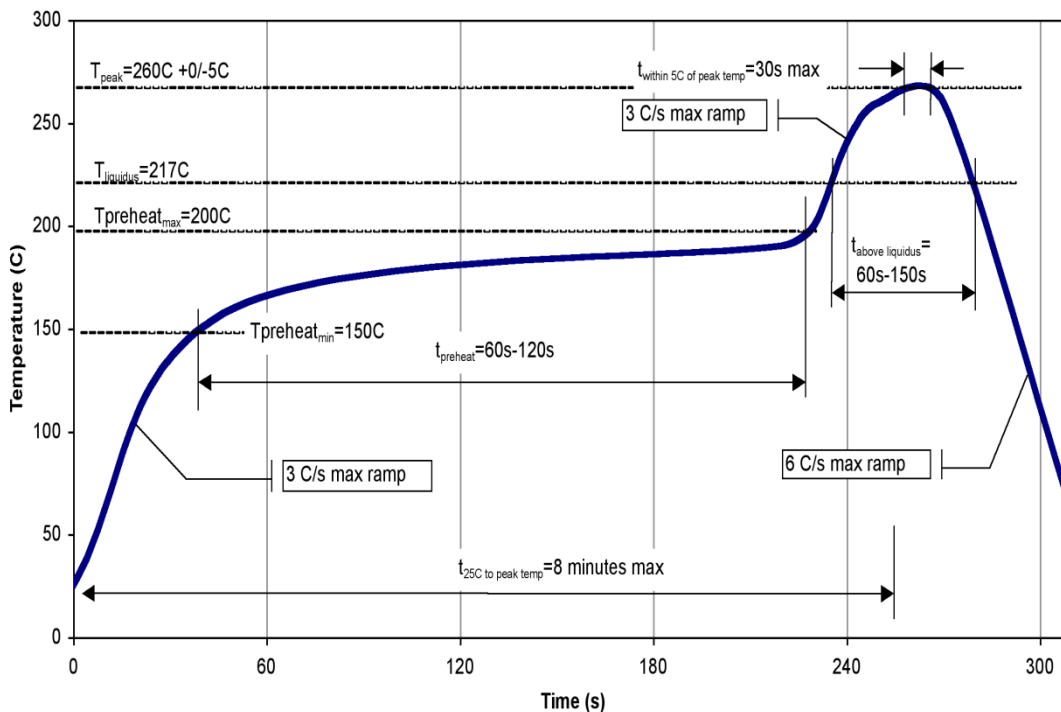

TGS2351-SM

DC – 6 GHz High Power SPDT Switch



Contact Information

For the latest specifications, additional product information, worldwide sales and distribution locations, and information about TriQuint:

Web: www.triquint.com
Email: info-sales@tqs.com

Tel: +1.972.994.8465
Fax: +1.972.994.8504

For technical questions and application information:

Email: info-products@tqs.com

Important Notice

The information contained herein is believed to be reliable. TriQuint makes no warranties regarding the information contained herein. TriQuint assumes no responsibility or liability whatsoever for any of the information contained herein. TriQuint assumes no responsibility or liability whatsoever for the use of the information contained herein. The information contained herein is provided "AS IS, WHERE IS" and with all faults, and the entire risk associated with such information is entirely with the user. All information contained herein is subject to change without notice. Customers should obtain and verify the latest relevant information before placing orders for TriQuint products. The information contained herein or any use of such information does not grant, explicitly or implicitly, to any party any patent rights, licenses, or any other intellectual property rights, whether with regard to such information itself or anything described by such information.

TriQuint products are not warranted or authorized for use as critical components in medical, life-saving, or life-sustaining applications, or other applications where a failure would reasonably be expected to cause severe personal injury or death.