

Cree® PLCC4 1 in 1 SMD LED

CLM2D-GPC/BPC (30-degree minimum)



PRODUCT DESCRIPTION

SMD LEDs is packaged in the industry standard package. These LEDs have high reliability performance and are designed to work under a wide range of environmental conditions. This high reliability feature makes them ideally suited to be used under Architectural lighting application conditions

These LEDs are suited for channel letter, or Architectural lighting applications. Cree has been certified in accordance with ISO/TS16949.

FEATURES

- Size (mm): 3.2 x 2.8
- Color and Typical Dominant Wavelength:
Green (520-535nm)
Blue (465 - 475nm)
- Luminous Intensity (mcd)
CLM2D-GPC: (5600 - 18000)
CLM2D-BPC: (1120 - 3550)
- Viewing angle:
CLM2D-GPC
30-degree minimum
CLM2D-BPC
30-degree minimum
- Moisture Sensitivity Level: 5a
- Lead-Free
- RoHS Compliant
- Untinted Diffused Lens

APPLICATIONS

- Channel Letter
- Architectural Lighting

ABSOLUTE MAXIMUM RATINGS ($T_A = 25^\circ\text{C}$)

Items	Symbol	Absolute Maximum Rating		Unit
		Green	Blue	
Forward Current	I_F	35		mA
Peak Forward Current ^{Note}	I_{FP}	100		mA
Reverse Voltage	V_R	5		V
Power Dissipation	P_D	140		mW
Operation Temperature	T_{opr}	-40 ~ +100		$^\circ\text{C}$
Storage Temperature	T_{stg}	-40 ~ +100		$^\circ\text{C}$
Junction Temperature	T_j	110		$^\circ\text{C}$
Junction/Ambient	R_{THJA}	450	320	$^\circ\text{C}/\text{W}$
Junction/Solder Point	R_{THJS}	220	150	$^\circ\text{C}/\text{W}$
Electrostatic Discharge Classification(MIL-STD-883E)	ESD	1000V		

Note: Pulse width ≤ 0.1 msec, duty $\leq 1/10$.

TYPICAL ELECTRICAL & OPTICAL CHARACTERISTICS ($T_A = 25^\circ\text{C}$)

Characteristics	Color	Symbol	Condition	Unit	Minimum	Typical	Maximum
Forward Voltage	Green	V_F	$I_F = 20$ mA	V		2.9	4.0
	Blue					3.1	4.0
Reverse Current	Green/Blue	I_R	$V_R = 5$ V	μA			10
Dominant Wavelength	Green	λ_D	$I_F = 20$ mA	nm	520	527.5	535
	Blue	λ_D	$I_F = 20$ mA	nm	465	470	475
Luminous Intensity	Green	I_V	$I_F = 20$ mA	mcd	5600	10000	
	Blue	I_V	$I_F = 20$ mA	mcd	1120	2000	
50% Power Angle	Green/ Blue	$2\theta_{1/2}$	$I_F = 20$ mA	deg	30		

INTENSITY BIN LIMIT ($I_F = 20 \text{ mA}$)

Green

Bin Code	Min. (mcd)	Max. (mcd)
A0	5600	7100
B0	7100	9000
C0	9000	11200
D0	11200	14000
E0	14000	18000

Blue

Bin Code	Min. (mcd)	Max. (mcd)
Wa	1120	1400
Wb	1400	1800
Xa	1800	2240
Xb	2240	2800
Ya	2800	3550

Tolerance of measurement of luminous intensity is $\pm 10\%$.

COLOR BIN LIMIT ($I_F = 20 \text{ mA}$)

Green

Bin Code	Min. (nm)	Max. (nm)
G7	520	525
G23	522.5	527.5
G8	525	530
G45	527.5	532.5
G9	530	535

Blue

Bin Code	Min. (nm)	Max. (nm)
B4	465	470
B45	467.5	472.5
B5	470	475

Tolerance of measurement of dominant wavelength is $\pm 1 \text{ nm}$.

ORDER CODE TABLE*

Color	Kit Number	Luminous Intensity (mcd)		Dominant Wavelength				Package
		Min.	Max.	Color Bin	Min.(nm)	Color Bin	Max.(nm)	
Green	CLM2D-GPC-CA0E0793	5600	18000	G7	520	G9	535	Reel
Green	CLM2D-GPC-CB0E0793	7100	18000	G7	520	G9	535	Reel
Green	CLM2D-GPC-CB0E0783	7100	18000	G7	520	G8	530	Reel

Color	Kit Number	Luminous Intensity (mcd)		Dominant Wavelength				Package
		Min.	Max.	Color Bin	Min.(nm)	Color Bin	Max.(nm)	
Blue	CLM2D-BPC-CWaYa453	1120	3550	B4	465	B5	475	Reel
Blue	CLM2D-BPC-CWbYa453	1400	3550	B4	465	B5	475	Reel

Notes:

1. The above kit numbers represent order codes that include multiple intensity-bin and color-bin codes. Only one intensity-bin code and one color-bin code will be shipped on each bulk. Single intensity-bin code and single color-bin codes will not be orderable.
2. Please refer to the "Cree LED Lamp Reliability Test Standards" document for reliability test conditions.
3. Please refer to the "Cree LED Lamp Soldering & Handling" document for information about how to use this LED product safely.

GRAPHS

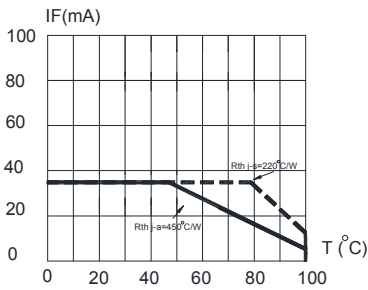
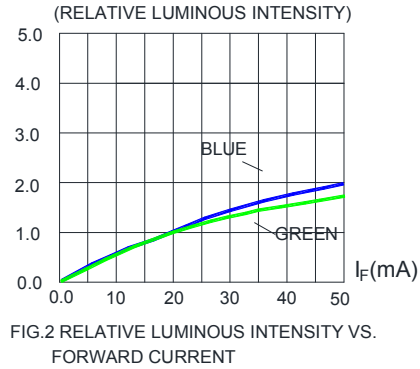
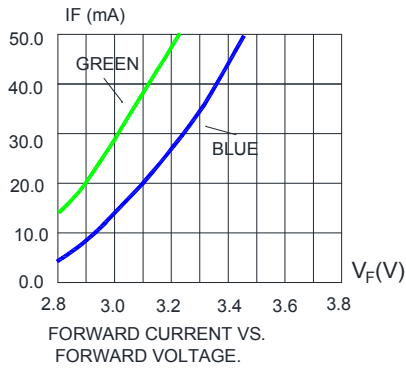

FIG.5 Green MAXIMUM FORWARD DC CURRENT VS AMBIENT TEMPERATURE (Tjmax=110°C)

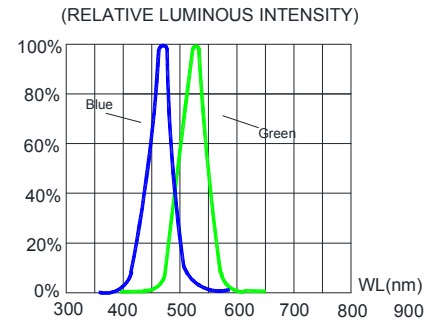

FIG.4 RELATIVE LUMINOUS INTENSITY VS. WAVELENGTH.

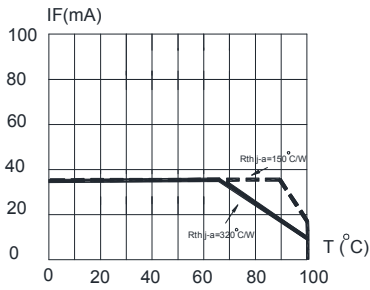

FIG.5 Blue MAXIMUM FORWARD DC CURRENT VS AMBIENT TEMPERATURE (Tjmax=110°C)

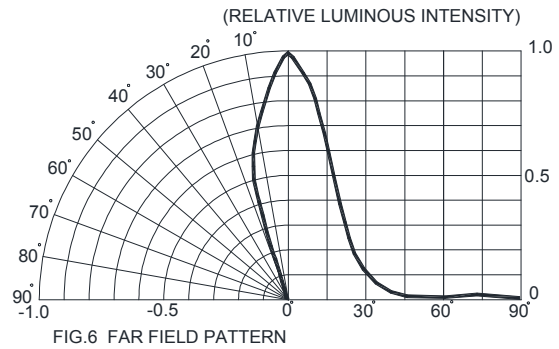
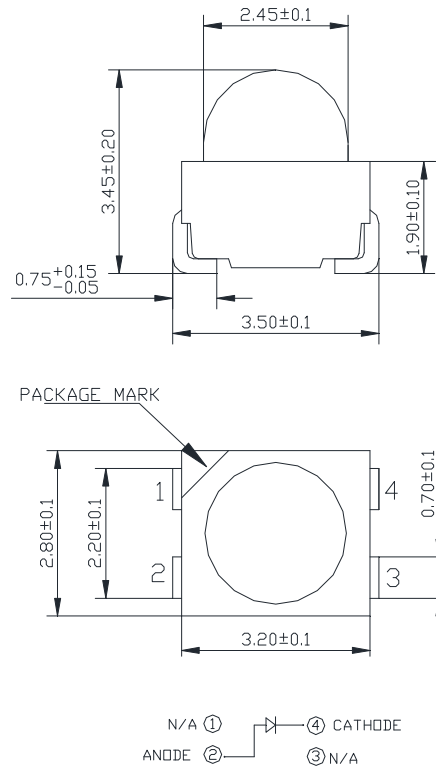

FIG.6 FAR FIELD PATTERN

The above data are collected from statistical figures that do not necessarily correspond to the actual parameters of each single LED. Hence, these data will be changed without further notice.

MECHANICAL DIMENSIONS

All dimensions are in mm.



NOTES

RoHS Compliance

The levels of environmentally sensitive, persistent biologically toxic (PBT), persistent organic pollutants (POP), or otherwise restricted materials in this product are below the maximum concentration values (also referred to as the threshold limits) permitted for such substances, or are used in an exempted application, in accordance with EU Directive 2002/95/EC on the restriction of the use of certain hazardous substances in electrical and electronic equipment (RoHS), as amended through April 21, 2006.

Vision Advisory Claim

Users should be cautioned not to stare at the light of this LED product. The bright light can damage the eye.

KIT NUMBER SYSTEM

Cree LED lamps are tested and sorted into performance bins. A bin is specified by ranges of color, forward voltage, and brightness. Sorted LEDs are packaged for shipping in various convenient options. Please refer to the "Cree LED Lamp Packaging Standard" document for more information about shipping and packaging options.

Cree LEDs are sold by order codes in combinations of bins called kits. Order codes are configured in the following manner:



PACKAGING

- The boxes are not water resistant and they must be kept away from water and moisture.
- The LEDs are packed in cardboard boxes after packaging in normal or anti-electrostatic bags.
- Cardboard boxes will be used to protect the LEDs from mechanical shocks during transportation.
- The reel pack is applied in SMD LED.
- Max 2300 pcs per reel.

