

3-Terminal EMI Filter

AEMIF-0805



RoHS/RoHS II Compliant



2.0 x 1.2 x 0.96mm

FEATURES:

- Multilayer and low profile structure enables high density mounting
- Closed magnetic circuit minimizes crosstalk
- Sharp attenuation characteristic beyond cutoff frequency achieves excellent EMI suppression
- Wide range of cutoff frequencies from 100MHz to 500MHz available

APPLICATIONS:

- Noise removal from signal lines in digital cameras, computers, game consoles, LED TVs, etc.
- Suppression of noise generated by high speed digital circuits such as clock lines

STANDARD SPECIFICATIONS:

Operating Temperature
-40°C to +85°C

Storage Temperature
-10°C to +40°C, 70% RH max. in tape and reel

Part Number	-3dB Cut-off Frequency	Cut-off Frequency Tolerance	Rated Voltage	Rated Current	Min. Insulation Resistance	Max. DC Resistance	Attenuation
Units	MHz	%	V	mA	MΩ	Ω	dB
AEMIF-0805-101M-16	100	M	16	200	200	1.5	20.0 dB min. at 250-2000 MHz
AEMIF-0805-151M-16	150	M	16	200	200	1.0	20.0 dB min. at 350-2000 MHz
AEMIF-0805-201M-16	200	M	16	250	200	1.0	20.0 dB min. at 450-2000 MHz
AEMIF-0805-301M-16	300	M	16	300	200	1.0	20.0 dB min. at 550-2000 MHz
AEMIF-0805-401M-16	400	M	16	300	200	0.8	20.0 dB min. at 800-2000 MHz
AEMIF-0805-501M-16	500	M	16	300	200	0.8	20.0 dB min. at 1000-2000 MHz

Test Equipment

Items	Test Equipment
Cut off Frequency	HP8753E or equivalent
DC Resistance	HP4338 or equivalent
Insulation Resistance	TH2682 or equivalent
Attenuation	HP8753E or equivalent

PART NUMBER IDENTIFICATION

AEMIF-0805- [] [] - [] - []

Cutoff Frequency
Please refer to the Table

Tolerance Code
M: ± 20%

Rated Voltage
Please refer to the Table

Packaging
T: 4kpcs/reel

ABRACON IS
ISO 9001:2008
CERTIFIED



Visit www.abracon.com for Terms & Conditions of Sale
30332 Esperanza, Rancho Santa Margarita, California 92688
tel 949-546-8000 | fax 949-546-800 | www.abracon.com

Revised: 07.28.14

3-Terminal EMI Filter

AEMIF-0805

 RoHS/RoHS II Compliant



2.0 x 1.2 x 0.96mm

FREQUENCY CHARACTERISTIC

AEMIF-0805-101M-16

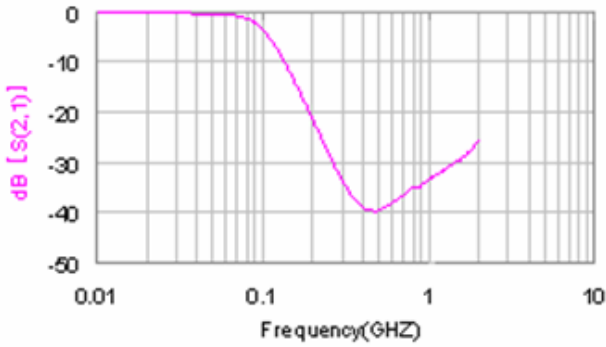

AEMIF-0805-151M-16

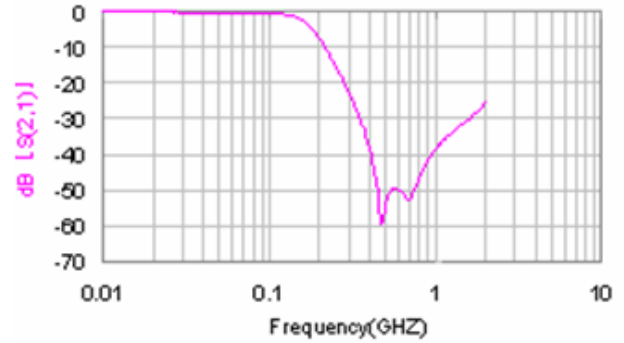

AEMIF-0805-201M-16

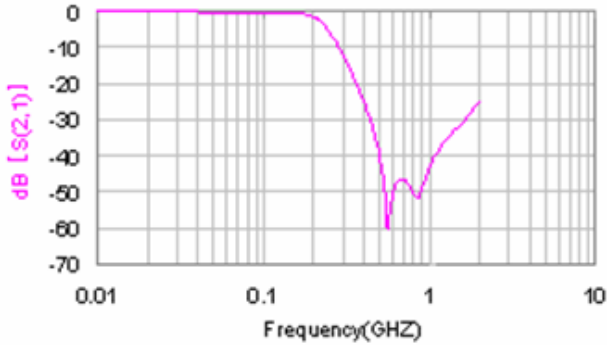

AEMIF-0805-301M-16

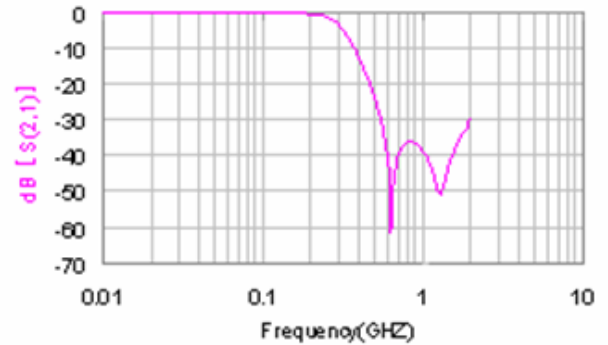

AEMIF-0805-401M-16

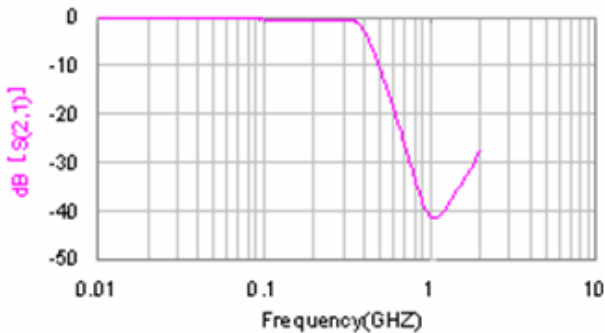

AEMIF-0805-501M-16

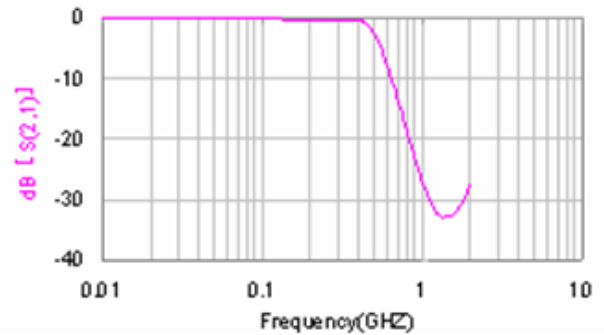

3-Terminal EMI Filter

AEMIF-0805

 RoHS/RoHS II Compliant



2.0 x 1.2 x 0.96mm

OUTLINE DIMENSION:

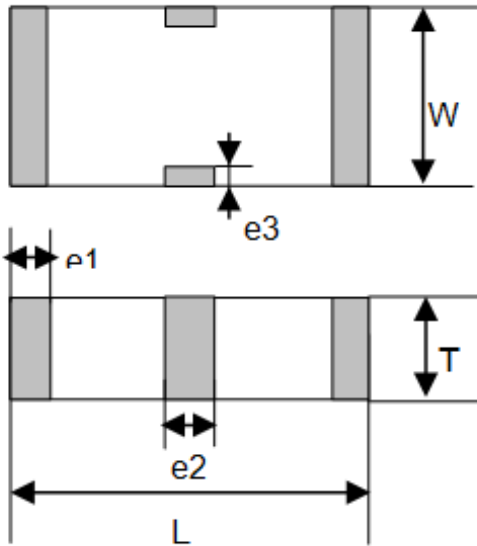

L	W	T	e1	e2	e3
2.0±0.2	1.2±0.2	0.96±0.2	0.3±0.15	0.5±0.15	0.3±0.15

A	B	C	D	E
0.6	1.4	3.2	1.2	2.2

Recommended Land Pattern

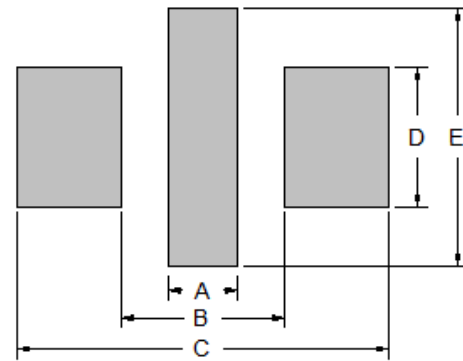

Dimension: mm

EQUIVALENT CIRCUIT:

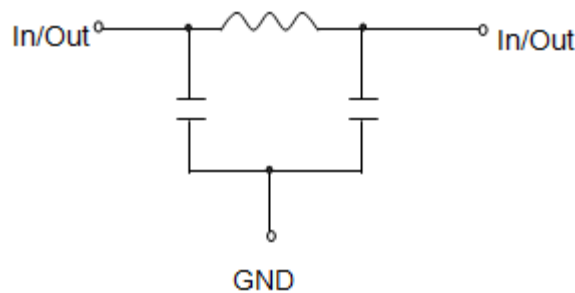

No polarity

3-Terminal EMI Filter

AEMIF-0805

 RoHS/RoHS II Compliant



2.0 x 1.2 x 0.96mm

REFLOW PROFILE:

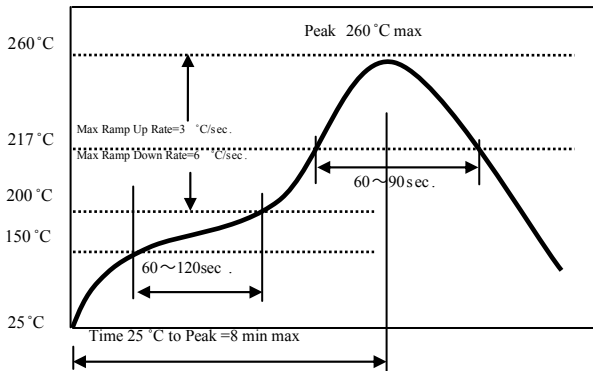

- Preheat condition: 150 ~200°C/60~120sec.
- Allowed time above 217 °C: 60~90sec.
- Max temp: 260 °C
- Max time at max temp: 10sec.
- Solder paste: Sn/3.0Ag/0.5Cu
- Allowed Reflow time: 2x max

TAPE & REEL

T= tape and reel (4,000pcs/reel)

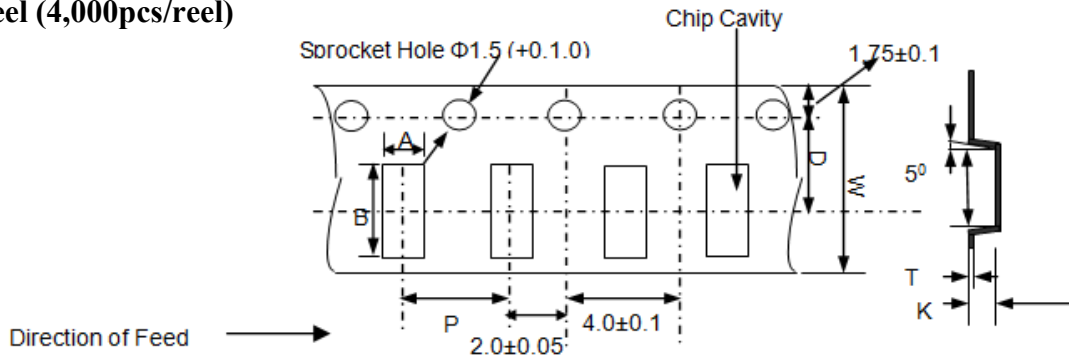

A	B	P	W	K max	T max
1.42	2.25	4.0	8.0	1.14	0.27

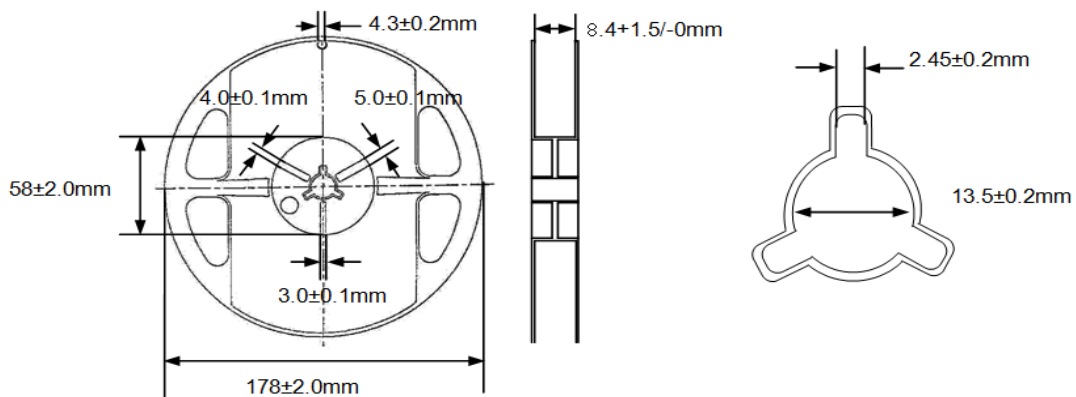

Dimension: mm

ATTENTION: Abracon Corporation's products are COTS – Commercial-Off-The-Shelf products; suitable for Commercial, Industrial and, where designated, Automotive Applications. Abracon's products are not specifically designed for Military, Aviation, Aerospace, Life-dependant Medical applications or any application requiring high reliability where component failure could result in loss of life and/or property. For applications requiring high reliability and/or presenting an extreme operating environment, written consent and authorization from Abracon Corporation is required. Please contact Abracon Corporation for more information.

ABRACON IS
ISO 9001:2008
CERTIFIED



Visit www.abracon.com for Terms & Conditions of Sale **Revised: 07.28.14**
30332 Esperanza, Rancho Santa Margarita, California 92688
tel 949-546-8000 | fax 949-546-800 | www.abracon.com