

**Features:**

- MEMS Technology
- Direct pin to pin drop-in replacement for industry-standard packages
- LVCMOS/HCMOS Compatible Output
- Industry-standard package 2.0 x 1.6, 2.5 x 2.0, 3.2 x 2.5, and 5.0 x 3.2 mm x mm
- Pb-free, RoHS and REACH compliant
- Fast delivery times

**Typical Applications:**

- Fibre Channel
- Server and Storage
- GPON, EPON
- 100M / 1G /10G Ethernet

**Electronic Specifications:**

|                                   |   |   |
|-----------------------------------|---|---|
| <b>Frequency Range</b>            | 1.000 MHz to 110.000MHz   |   |
| <b>Frequency Stability</b>        | See Part Number Guide   | Inclusive of Initial Tolerance, Operating Temperature Range, Load, Voltage, and Aging   |
| <b>Operating Temperature</b>      | See Part Number Guide   |   |
| <b>Supply Voltage (Vdd) ±10%</b>  | See Part Number Guide   |   |
| <b>Current Consumption</b>        | 3.8 mA typ./ 4.7 mA max<br>3.6 mA typ./ 4.5 mA max<br>3.5 mA typ./ 4.5 mA max | No load condition, F = 20 MHz, Vdd = +2.8 V, +3.0 V or +3.3 V<br>No load condition, F = 20 MHz, Vdd = +2.5 V<br>No load condition, F = 20 MHz, Vdd = +1.8 V |
| <b>OE Disable Current</b>         | 4.5 mA max<br>4.3 mA max  | Vdd = +2.5 V, to +3.3 V, OE = Low, output is high Z state<br>Vdd = +1.8 V, OE = Low, output is high Z state   |
| <b>Standby Current</b>            | 2.6 µA typ./ 8.5 µA max<br>1.4 µA typ./ 5.5 µA max<br>0.6 µA typ./ 4.0 µA max | Vdd = +2.8 V to 3.3 V, $\overline{ST}$ = low<br>Vdd = +2.5 V, $\overline{ST}$ = Low<br>Vdd = +1.8 V, $\overline{ST}$ = Low                                  |
| <b>Waveform Output</b>            | LVCMOS/HCMOS  |   |
| <b>Symmetry</b>                   | 45%/55%   | 50% of waveform   |
| <b>Rise / Fall Time</b>           | 1.0 nSec typ./ 2.0 nSec max<br>1.3 nSec typ./ 2.5 nSec max                    | Vdd = +2.5 V, +2.8 V, 3.0 V or 3.3 V from 20% to 80% of waveform<br>Vdd = +1.8 V, from 20% or 80% of waveform   |
| <b>Logic "1"</b>                  | 90% of Vdd min  |   |
| <b>Logic "0"</b>                  | 10% of Vdd max  |   |
| <b>Input Voltage High</b>         | 70% of Vdd min  | Pin 1, OE or $\overline{ST}$  |
| <b>Input Voltage Low</b>          | 30% of Vdd max  | Pin 1, OE or $\overline{ST}$  |
| <b>Input Pull-up Impedance</b>    | 50 kΩ min, 87 kΩ typ./ 150 kΩ max<br>2.0 MΩ min                               | Pin 1, OE logic high or logic low, or $\overline{ST}$ logic high<br>Pin 1, $\overline{ST}$ logic low  |
| <b>Startup Time</b>               | 5 mSec max  | Measured from the time Vdd reaches its rated minimum values   |
| <b>Enable/Disable Time</b>        | 130 nSec max  | F = 110 MHz, For other frequencies, T <sub>oe</sub> = 100 nSec + 3 * clock periods  |
| <b>Resume Time</b>                | 5 mSec max  | Measured from the time $\overline{ST}$ pin crosses 50% threshold.   |
| <b>RMS Period Jitter</b>          | 1.6 pSec typ./ 2.5 pSec max<br>1.9 pSec typ./ 3.0 pSec max                    | F = 75 MHz, Vdd = +2.5 V, +2.8 V, +3.0 V or +3.3 V<br>F = 75 MHz, Vdd = +1.8 V  |
| <b>Peak-to-Peak Period Jitter</b> | 12 pSec typ./ 20 pSec max<br>14 pSec typ./ 25 pSec max                        | F = 75 MHz, Vdd = +2.5 V, +2.8 V, +3.0 V or +3.3 V<br>F = 75 MHz, Vdd = +1.8 V  |
| <b>RMS Period Jitter (random)</b> | 0.5 pSec typ./ 0.8 pSec max<br>1.3 pSec typ./ 2.0 pSec max                    | F = 75 MHz, Integration bandwidth = 900 kHz to 7.5 MHz<br>F = 75 MHz, Integration bandwidth = 12.0 kHz to 20.0 MHz  |

**Notes:**

- All min and max limits are specified over temperature and rated operating voltage with 15pF output unless otherwise stated.
- Typical values are at +25°C and nominal supply voltage.

**Ordering Information:**

| Part Number Guide  |                          |                       |                          |                 |                 |             |
|--------------------|--------------------------|-----------------------|--------------------------|-----------------|-----------------|-------------|
| Packages           | Input Voltage            | Operating Temperature | Output Drive Strength    | Stability (ppm) | Select Function | Frequency   |
| IM820B – 5.0 X 3.2 | 1 = +1.8 V               | E = -40°C to +105°C   | - = Default              | F = ±20         | H = Tri-state   | - Frequency |
| IM820C – 3.2 x 2.5 | 6 = +2.5 V               | F = -40°C to +125°C   | (see tables 2 through 5) | A = ±25         | S = Standby     |             |
| IM820D – 2.5 x 2.0 | 2 = +2.8 V               |                       |                          | Z = ±30         | O = N/C         |             |
| IM820E – 2.0 x 1.6 | 7 = +3.0 V<br>3 = +3.3 V |                       |                          | B = ±50         |                 |             |

**Sample Part Number: IM820E-1E-FS-50.0000 MHz**

This 50.0000 MHz oscillator in a 1.6 x 2.0 package with stability ±20 ppm from -40°C to +105°C using a supply voltage of +1.8 V. The Output Drive Strength (Rise and Fall Time) is 2.40 nSec per Table 1 with 30 pF load. With Pin 1 function as Standby

**Sample Part Number: IM820C-1F-AH-66.0000 MHz**

This 66.0000 MHz oscillator in a 2.5 x 3.2 package with stability ±25 ppm from -40°C to +125°C using a supply voltage of +1.8 V. The Output Drive Strength (Rise and Fall Time) is 2.40 nSec per Table 1 with 30 pF load. With Pin 1 function as Tri-state

**Notes:**

- Not all options are available at all frequencies and temperatures ranges.
- Please consult with sales department for any other parameters or options.
- Oscillator specification subject to change without notice.

| Absolute Maximum Limits   |                     |
|---|---------------------|
| Storage Temperature   | -65°C to +150°C     |
| Supply Voltage (Vdd)  | -0.5 VDC to 4.0 VDC |
| Electrostatic Discharge   | 2000 V max          |
| Solder Temperature (follow standard Pb free soldering guidelines) | 260°C max           |
| Junction Temperature  | 150°C max           |

**Test Circuit**

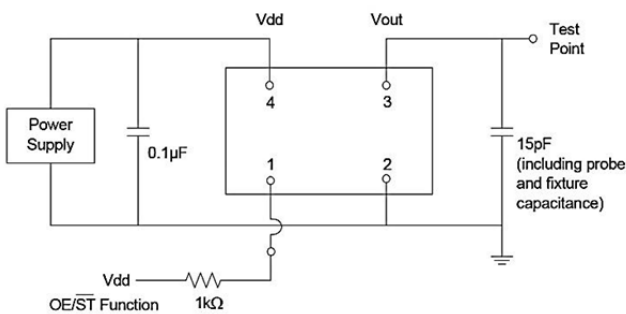

**Waveform**

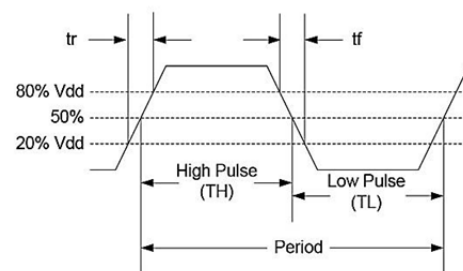

**Performance Plots:**

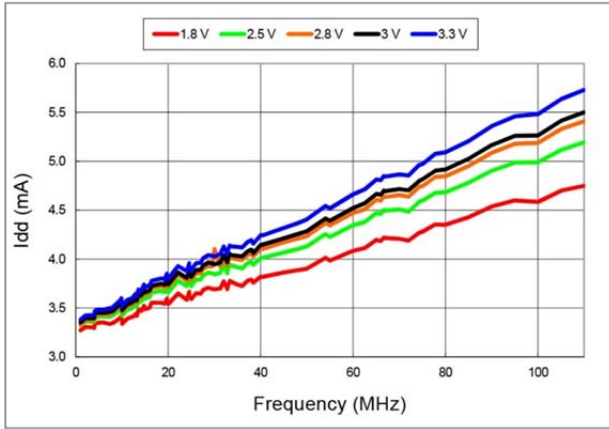

Figure 1: Idd vs Frequency

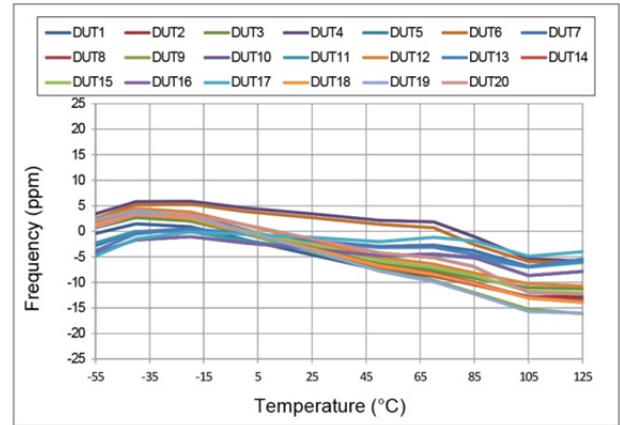

Figure 2: Frequency vs Temperature

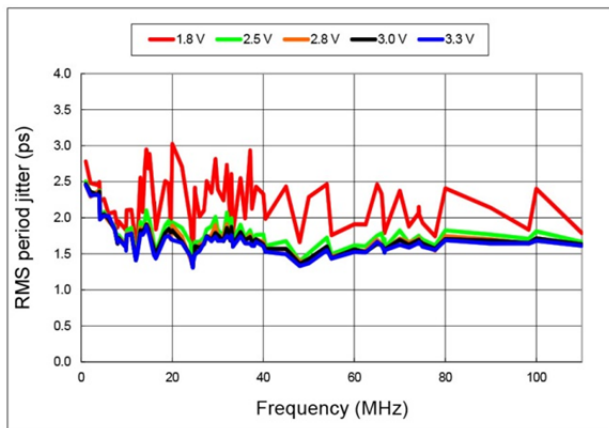

Figure 3: RMS Period Jitter vs Frequency

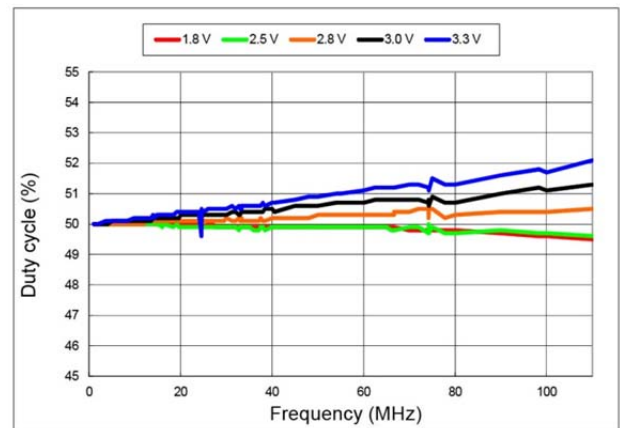

Figure 4: Duty Cycle vs Frequency

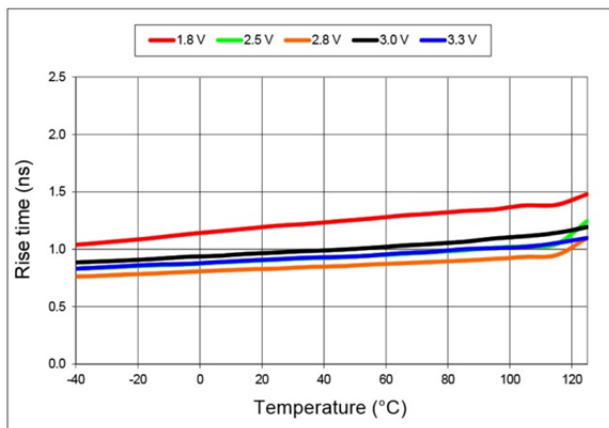

Figure 5: 20% to 80% Rise Time vs Temperature

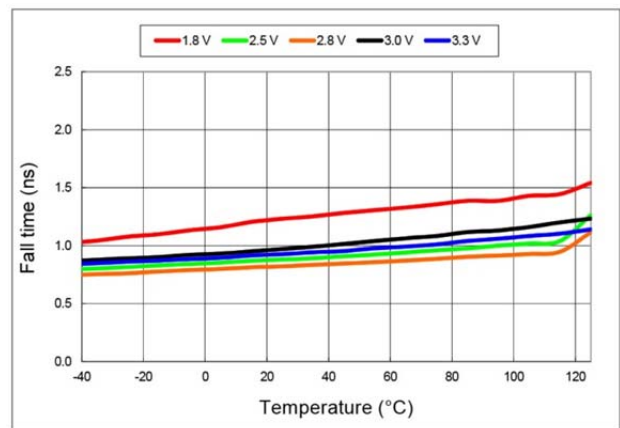

Figure 6: 20% to 80% Fall Time vs Temperature

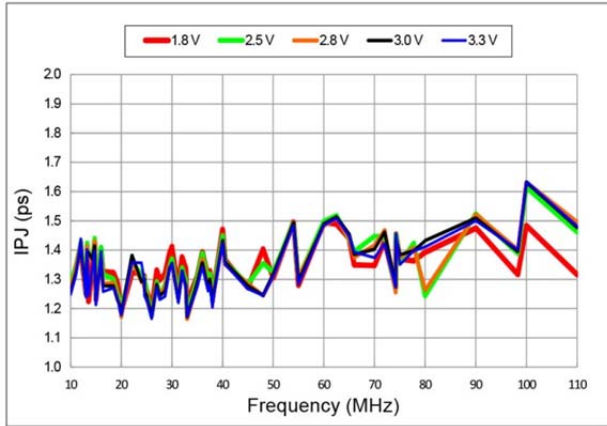

Figure 7: RMS Integrated Phase Jitter Random (12 kHz to 20.0 MHz) vs. Frequency

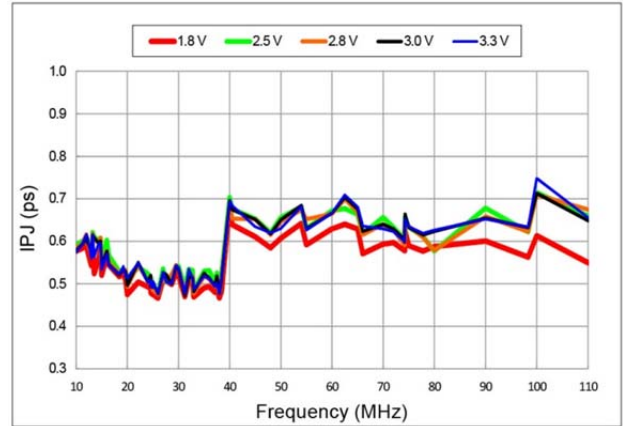
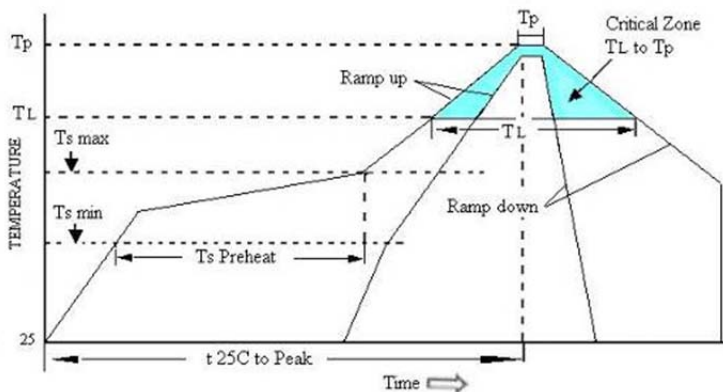

Figure 8: RMS Integrated Phase Jitter Random (900 kHz to 20.0 MHz) vs. Frequency

**Environmental Specifications:**

| Environmental Compliance   |                           |
|----------------------------|---------------------------|
| Parameter                  | Condition/Test Method     |
| Mechanical Shock           | MIL-STD-883F, Method 2002 |
| Mechanical Vibration       | MIL-STD-883F, Method 2007 |
| Temperature Cycle          | JESD22, Method A104       |
| Solderability              | MIL-STD-883F, Method 2003 |
| Moisture Sensitivity Level | MSL Level 1 at +260°C     |

**Pb Free Solder Reflow Profile**



Units are backward compatible with +240°C reflow processes

|  |                       |
|--|-----------------------|
| Ts max to TL (Ramp-up Rate)              | 3°C / second max      |
| Preheat                                  |                       |
| Temperature min (Ts min)                 | 150°C                 |
| Temperature typ (Ts typ)                 | 175°C                 |
| Temperature max (Ts max)                 | 200°C                 |
| Time (Ts)                                | 60 to 180 seconds     |
| Ramp-up Rate (TL to Tp)                  | 3°C / second max      |
| Time Maintained Above Temperature (TL)   | 217°C                 |
| Time (TL)                                | 60 to 150 seconds     |
| Peak Temperature (Tp)                    | 260°C max for seconds |
| Time within 5°C to Peak Temperature (Tp) | 20 to 40 seconds      |
| Ramp-down Rate                           | 6°C / second max      |
| Time 25°C to Peak Temperature            | 8 minute max          |
| Moisture Sensitivity Level (MSL)         | Level 1               |

**Pin Functionally**

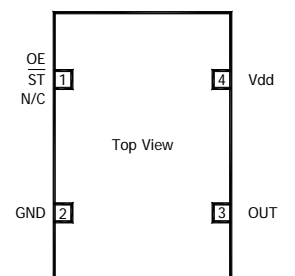
| Pin Description |                 |            |  | Pin Assignments   |
|-----------------|-----------------|------------|--|---|
| Pin             | Symbol          |            | Functionality  |   |
| 1               | OE              | Tri-state  | High or Open = specified frequency output<br>Low = Output is high impedance, only output is disabled.                                    |  <p>Top View</p> |
|                 | $\overline{ST}$ | Standby    | High or Open = specified frequency output.<br>Low = Output is low. Device goes to sleep mode. Supply current reduces to standby current. |   |
|                 | N/C             | No Connect | Any voltage between 0.0 V to Vdd or Open = specified frequency output<br>Pin 1 has no function   |   |
| 2               | GND             | Power      | Electrical ground  |   |
| 3               | Out             | Output     | Oscillator output  |   |
| 4               | Vdd             | Power      | Power supply voltage   |   |

**Notes:**

- In OE or  $\overline{ST}$  mode, a pull-up resistor of 10.0 k $\Omega$  or less is recommended if Pin 1 is not externally driven. If Pin 1 needs to be left floating, use the NC option.
- A capacitor of value 0.1  $\mu$ F or higher between Pin 4 (Vdd) and Pin 1 (GND) is required.

**Pin 1 Configuration Options (OE, or  $\overline{ST}$ , or NC)**

Pin 1 of the IM820 can be factory-programmed to support three modes: Output Enable (OE), Standby ( $\overline{ST}$ ) or No Connect (NC).

**Output Enable (OE) Mode**

In the OE mode, applying logic Low to the OE pin only disables the output driver and puts it in Hi-Z mode. The core of the device continues to operate normally. Power consumption is reduced due to the inactivity of the output. When the OE pin is pulled High, the output is typically enabled in <1  $\mu$ Sec.

**Standby  $\overline{ST}$  Mode**

In the ST mode, a device enters into the standby mode when Pin 1 pulled Low. All internal circuits of the device are turned off. The current is reduced to a standby current, typically in the range of a few  $\mu$ A. When  $\overline{ST}$  is pulled High, the device goes through the "resume" process, which can take up to 5 mSec.

**No Connect (NC) Mode**

In the NC mode, the device always operates in its normal mode and outputs the specified frequency regardless of the logic level on Pin 1.

Table 1 below summarizes the key relevant parameters in the operation of the device in OE, ST, or NC mode.

| Parameters                                    | OE       | ST          | NC     |
|---|----------|-------------|--------|
| Active current 20.0 MHz (max +1.80 VDC)       | 6.0 mA   | 6.0 mA      | 6.0 mA |
| OE disable current (max +1.80 VDC)            | 4.5 mA   | N/A         | N/A    |
| Standby current (typical +1.80 VDC)           | N/A      | 0.6 $\mu$ A | N/A    |
| OE enable time at 20.0 MHz (max)              | 130 nSec | N/A         | N/A    |
| Resume time from standby (max, all frequency) | N/A      | 5 mSec      | N/A    |
| Output driver in OE disable/standby mode      | High Z   |             | N/A    |

**Table 1 OE vs.  $\overline{ST}$  vs. NC**

Timing Diagram:

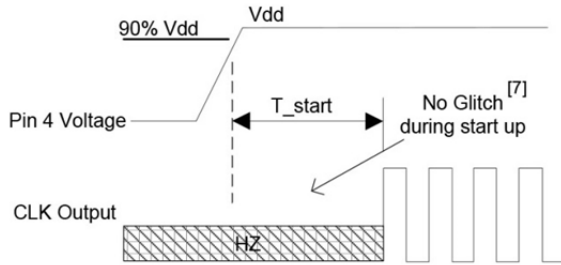

T\_start: Time to start from power-off

Figure 11: Startup Timing (OE/ $\overline{ST}$  Mode)

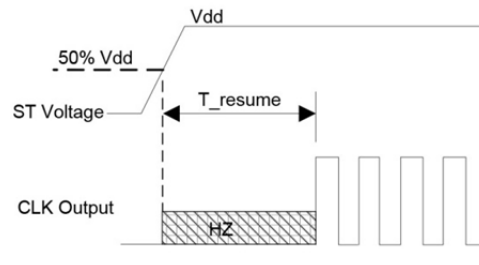

T\_resume: Time to resume from ST

Figure 12: Standby Resume Timing ( $\overline{ST}$  Mode Only)

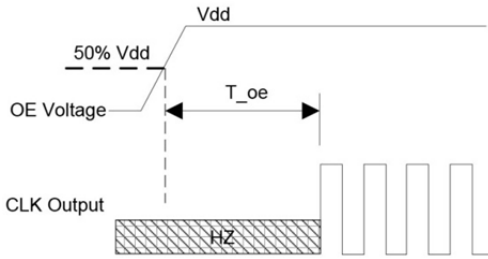

T\_oe: Time to re-enable the clock output

Figure 13: OE Enable Timing (OE Mode Only)

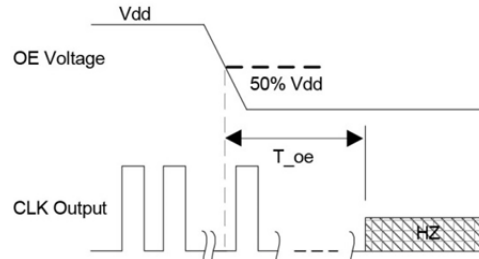

T\_oe: Time to put the output in High Z mode

Figure 14: OE Disable Timing (OE Mode Only)

Selectable Drive Strength Option  
Rise/Fall Time (20% to 80%) vs C<sub>LOAD</sub> Tables

| Rise/Fall Time Typ (nS)             |      |       |       |       |       |
|-------------------------------------|------|-------|-------|-------|-------|
| Drive Strength (C <sub>LOAD</sub> ) | 5 pF | 15 pF | 30 pF | 45 pF | 60 pF |
| L                                   | 6.16 | 11.61 | 22.00 | 31.27 | 39.91 |
| A                                   | 3.19 | 6.35  | 11.00 | 16.01 | 21.52 |
| R                                   | 2.11 | 4.31  | 7.65  | 10.77 | 14.47 |
| B                                   | 1.65 | 3.23  | 5.79  | 8.18  | 11.08 |
| T                                   | 0.93 | 1.91  | 3.32  | 4.66  | 6.48  |
| E                                   | 0.78 | 1.66  | 2.94  | 4.09  | 5.74  |
| U                                   | 0.70 | 1.48  | 2.64  | 3.68  | 5.09  |
| - = Default                         | 0.65 | 1.30  | 2.40  | 3.35  | 4.56  |

Table 2: V<sub>dd</sub> = +1.8 V Rise/Fall time for Specific C<sub>LOAD</sub>

| Rise/Fall Time Typ (nS)             |      |       |       |       |       |
|-------------------------------------|------|-------|-------|-------|-------|
| Drive Strength (C <sub>LOAD</sub> ) | 5 pF | 15 pF | 30 pF | 45 pF | 60 pF |
| L                                   | 4.13 | 8.25  | 12.82 | 21.45 | 27.79 |
| A                                   | 2.11 | 4.27  | 7.64  | 11.20 | 14.49 |
| R                                   | 1.45 | 2.81  | 5.16  | 7.65  | 9.88  |
| B                                   | 1.09 | 2.20  | 3.88  | 5.86  | 7.57  |
| T                                   | 0.62 | 1.28  | 2.27  | 3.51  | 4.45  |
| - = Default                         | 0.54 | 1.00  | 2.01  | 3.10  | 4.01  |
| U                                   | 0.43 | 0.96  | 1.81  | 2.79  | 3.65  |
| F                                   | 0.34 | 0.88  | 1.64  | 2.54  | 3.32  |

Table 3: V<sub>dd</sub> = +2.5 V Rise/Fall time for Specific C<sub>LOAD</sub>

| Rise/Fall Time Typ (nS)             |      |       |       |       |       |
|-------------------------------------|------|-------|-------|-------|-------|
| Drive Strength (C <sub>LOAD</sub> ) | 5 pF | 15 pF | 30 pF | 45 pF | 60 pF |
| L                                   | 3.77 | 7.54  | 12.28 | 19.57 | 25.27 |
| A                                   | 1.94 | 3.90  | 7.03  | 12.04 | 13.34 |
| R                                   | 1.29 | 2.57  | 4.72  | 7.01  | 9.06  |
| B                                   | 0.97 | 2.00  | 3.54  | 5.43  | 6.93  |
| T                                   | 0.55 | 1.12  | 2.08  | 3.22  | 4.08  |
| - = Default                         | 0.44 | 1.00  | 1.83  | 2.82  | 3.67  |
| U                                   | 0.34 | 0.88  | 1.64  | 2.52  | 3.30  |
| F                                   | 0.29 | 0.81  | 1.48  | 2.29  | 2.99  |

Table 4: V<sub>dd</sub> = +2.8 V Rise/Fall time for Specific C<sub>LOAD</sub>

| Rise/Fall Time Typ (nS)             |      |       |       |       |       |
|-------------------------------------|------|-------|-------|-------|-------|
| Drive Strength (C <sub>LOAD</sub> ) | 5 pF | 15 pF | 30 pF | 45 pF | 60 pF |
| L                                   | 3.60 | 7.21  | 11.97 | 18.74 | 24.30 |
| A                                   | 1.84 | 3.71  | 6.72  | 9.86  | 12.68 |
| R                                   | 1.22 | 2.46  | 4.54  | 6.76  | 8.62  |
| B                                   | 0.89 | 1.92  | 3.39  | 5.20  | 6.64  |
| - = Default                         | 0.51 | 1.00  | 1.97  | 3.07  | 3.90  |
| E                                   | 0.38 | 0.92  | 1.72  | 2.71  | 3.51  |
| U                                   | 0.30 | 0.83  | 1.55  | 2.40  | 3.13  |
| F                                   | 0.27 | 0.76  | 1.39  | 2.16  | 2.85  |

Table 5: V<sub>dd</sub> = +3.0 V Rise/Fall time for Specific C<sub>LOAD</sub>

| Rise/Fall Time Typ (nS)             |      |       |       |       |       |
|-------------------------------------|------|-------|-------|-------|-------|
| Drive Strength (C <sub>LOAD</sub> ) | 5 pF | 15 pF | 30 pF | 45 pF | 60 pF |
| L                                   | 3.39 | 6.88  | 11.63 | 17.56 | 23.59 |
| A                                   | 1.74 | 3.50  | 6.38  | 8.98  | 12.19 |
| R                                   | 1.16 | 2.33  | 4.29  | 6.04  | 8.34  |
| B                                   | 0.81 | 1.82  | 3.22  | 4.52  | 6.33  |
| - = Default                         | 0.46 | 1.00  | 1.86  | 2.60  | 3.84  |
| E                                   | 0.33 | 0.87  | 1.64  | 2.30  | 3.35  |
| U                                   | 0.28 | 0.79  | 1.46  | 2.05  | 2.93  |
| F                                   | 0.25 | 0.72  | 1.31  | 1.83  | 2.61  |

Table 6: V<sub>dd</sub> = +3.3 V Rise/Fall time for Specific C<sub>LOAD</sub>

**Mechanical Details:**

**Package Dimensions and Suggest Land Pattern**

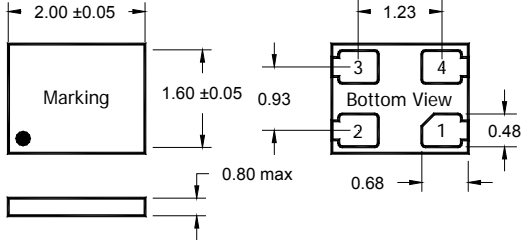
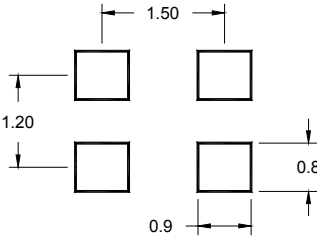
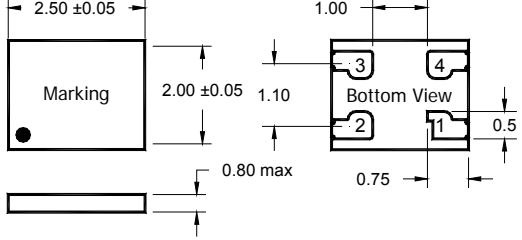
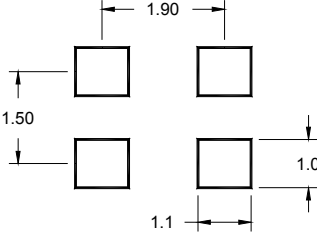
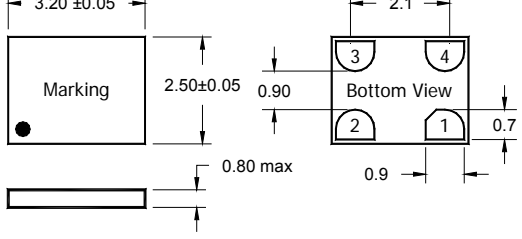
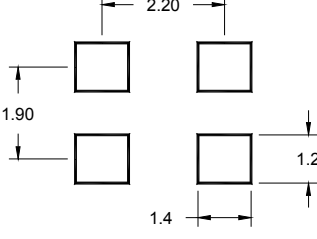
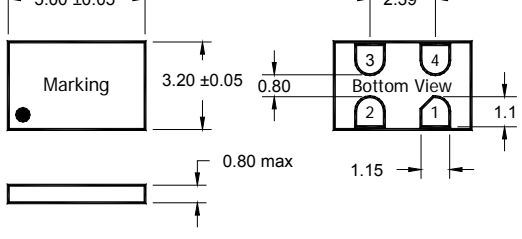
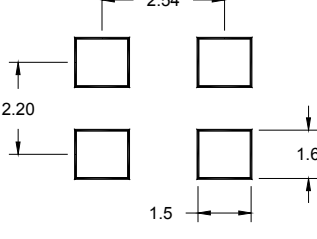
|   |  |
|---|--|
| <p>Option E: 2.00 x 1.60 x 0.80 Package</p>    | <p>Suggested Land Pattern</p>    |
| <p>Option D: 2.50 x 2.00 x 0.80 Package</p>   | <p>Suggested Land Pattern</p>   |
| <p>Option C: 3.20 x 2.50 x 0.80 Package</p>  | <p>Suggested Land Pattern</p>  |
| <p>Option B: 5.00 x 3.20 X 0.80 Package</p>  | <p>Suggested Land Pattern</p>  |

**Marking**

Line 1 = XXXXX (Lot code)  
Dot to denote Pin 1 location

**Package Information**

Leadframe: C194  
Plating: NiPdAu

**Tape and Reel Dimensions**

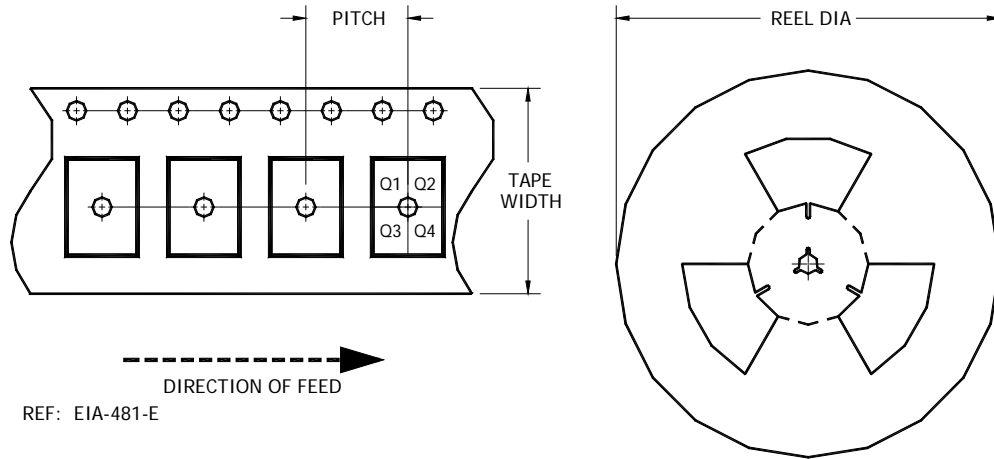

| Part Number | Size      | Pitch     | Tape Width | Pin Orient. | Reel Dia. | Count |
|-------------|-----------|-----------|------------|-------------|-----------|-------|
| IM821B      | 5.0 x 3.2 | 8.0 ± 0.1 | 12.3 max   | Q1          | 180 Dia   | 1000  |
|             |           |           |            |             | 330 Dia   | 3000  |
| IM821C      | 3.2 x 2.5 | 4.0 ± 0.1 | 8.3 max    | Q1          | 180 Dia   | 3000  |
| IM821D      | 2.5 x 2.0 | 4.0 ± 0.1 | 8.3 max    | Q1          | 180 Dia   | 3000  |
| IM821E      | 2.0 x 1.6 | 4.0 ± 0.1 | 8.3 max    | Q1          | 180 Dia   | 3000  |

Notes:

- All dimensions are in mm.
- Do not scale drawings.

**PROPRIETARY AND CONFIDENTIAL**

THIS DOCUMENT CONTAINS PROPRIETARY INFORMATION, AND SUCH INFORMATION MAY NOT BE DISCLOSED TO OTHERS FOR ANY PURPOSE NOR USED FOR MANUFACTURING PURPOSES WITHOUT WRITTEN PERMISSION FROM ILSI America.