

# High Brightness Type Side view chip LEDs

## SML-A12 Series

Package Size (mm)	Green	Yellow	Orange	Red
	AlGaInP on GaAs			
	570nm	590nm	611nm	630nm
1611 (0605) 1.6×1.15 t=0.55				
	SML-A12MT	SML-A12WT	SML-A12DT	SML-A12UT

### Absolute Maximum Ratings (Ta=25°C)

Part No.	Emitting color	Power dissipation Pd (mW)	Forward current IF (mA)	Peak forward current * I <sub>FP</sub> (mA)	Reverse voltage VR (V)	Operating temperature T <sub>opr</sub> (°C)	Storage temperature T <sub>stg</sub> (°C)
SML-A12MT	Green	65	25	100	5	-30 to +85	-40 to +85
SML-A12WT	Yellow	75	30			-40 to +85	-40 to +100
SML-A12DT	Orange			-40 to +85	-40 to +100		
SML-A12UT	Red						

\* I<sub>FP</sub> measured under duty ≤ 1/5, pulse width ≤ 1ms.

### External Dimensions (Unit : mm)

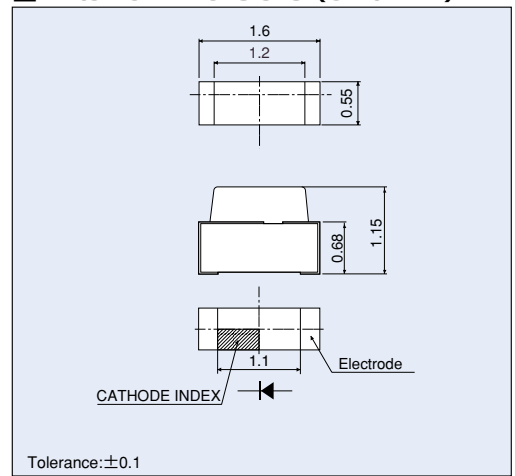

### Electrical Optical Characteristics (Ta=25°C)

Part No.	Resin Color	Forward voltage VF		Reverse current IR		Light wavelength Peak Half-wave			Brightness Iv		
		Typ. (V)	IF (mA)	Max. (μA)	VR (V)	Typ. (nm)	Typ. (nm)	IF (mA)	Min. (mcd)	Typ. (mcd)	IF (mA)
SML-A12MT	Transparent Clear	2.1	20	100	5	570	18	20	14	40	20
SML-A12WT		2.0		10		590	15		63		
SML-A12DT		611	16	36		100					
SML-A12UT		630	18								

### Directivity

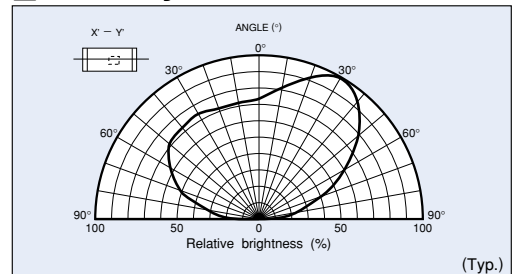

### Recommended Pad Layout

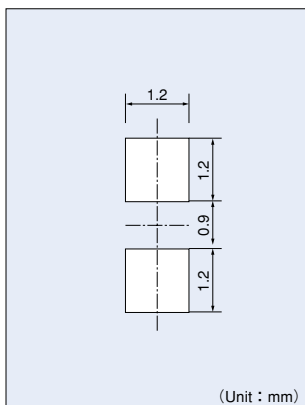

(Unit : mm)

The recommended thickness of the screen mask for soldering is more than 150μm. The hole size of the screen mask should be same as the recommended land pattern or smaller.

### Packaging Specifications (Unit : mm)

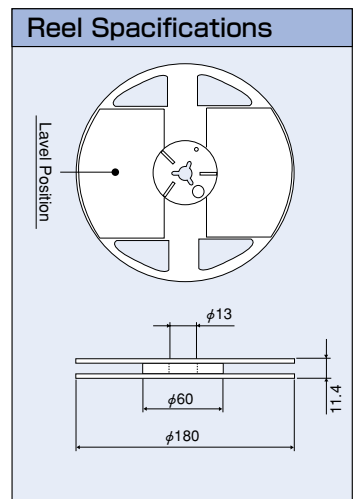
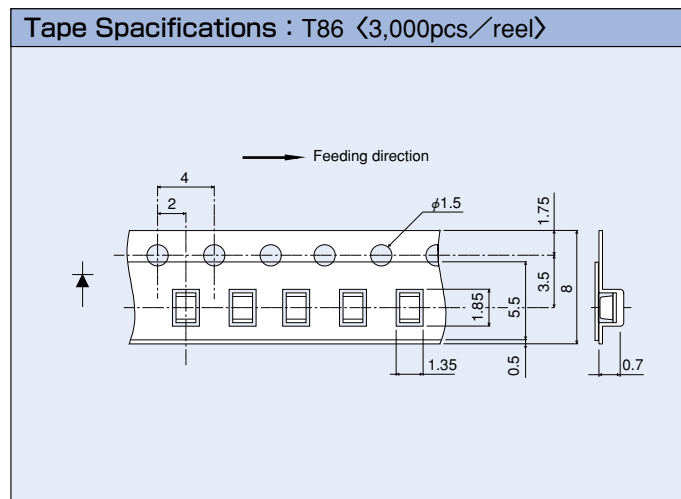

## Electrical Characteristic Curves

### Forward Current - Forward Voltage

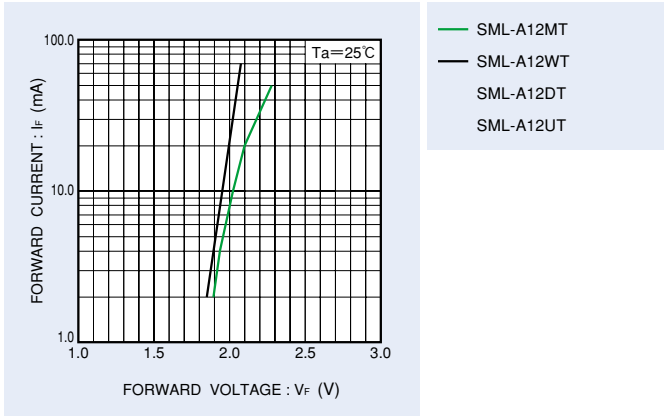

### Relative Luminous Intensity - Case Temperature

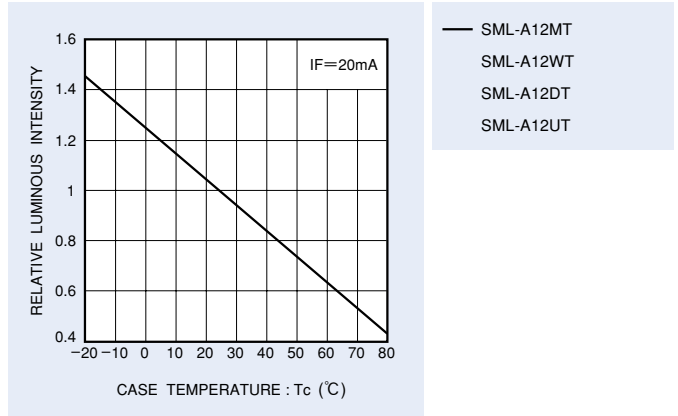

### Relative Luminous Intensity - Forward Current

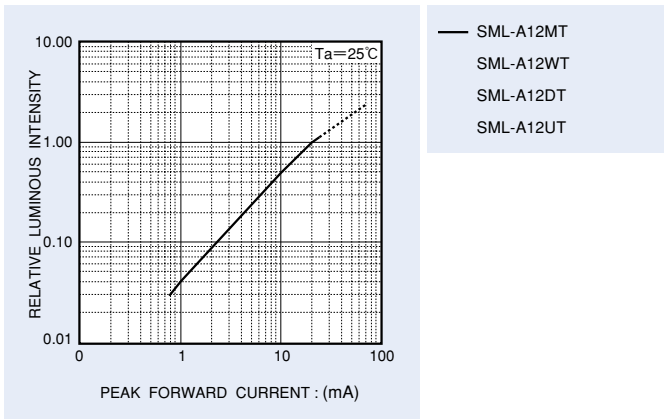

### Ratio of Maximum Tolerable Peak Current - Pulse Duration

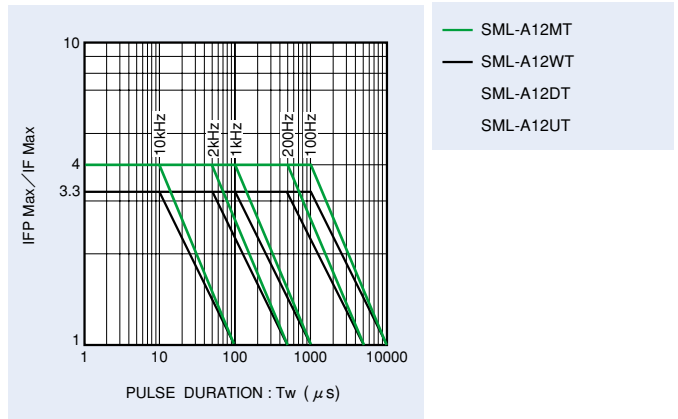

## Derating

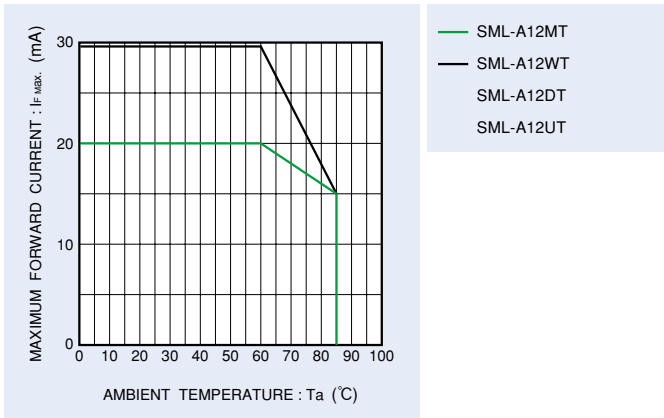

### Notes

- No technical content pages of this document may be reproduced in any form or transmitted by any means without prior permission of ROHM CO.,LTD.
- The contents described herein are subject to change without notice. The specifications for the product described in this document are for reference only. Upon actual use, therefore, please request that specifications to be separately delivered.
- Application circuit diagrams and circuit constants contained herein are shown as examples of standard use and operation. Please pay careful attention to the peripheral conditions when designing circuits and deciding upon circuit constants in the set.
- Any data, including, but not limited to application circuit diagrams information, described herein are intended only as illustrations of such devices and not as the specifications for such devices. ROHM CO.,LTD. disclaims any warranty that any use of such devices shall be free from infringement of any third party's intellectual property rights or other proprietary rights, and further, assumes no liability of whatsoever nature in the event of any such infringement, or arising from or connected with or related to the use of such devices.
- Upon the sale of any such devices, other than for buyer's right to use such devices itself, resell or otherwise dispose of the same, no express or implied right or license to practice or commercially exploit any intellectual property rights or other proprietary rights owned or controlled by
- ROHM CO., LTD. is granted to any such buyer.
- Products listed in this document are no antiradiation design.

The products listed in this document are designed to be used with ordinary electronic equipment or devices (such as audio visual equipment, office-automation equipment, communications devices, electrical appliances and electronic toys).

Should you intend to use these products with equipment or devices which require an extremely high level of reliability and the malfunction of which would directly endanger human life (such as medical instruments, transportation equipment, aerospace machinery, nuclear-reactor controllers, fuel controllers and other safety devices), please be sure to consult with our sales representative in advance.

#### About Export Control Order in Japan

Products described herein are the objects of controlled goods in Annex 1 (Item 16) of Export Trade Control Order in Japan.

In case of export from Japan, please confirm if it applies to "objective" criteria or an "informed" (by MITI clause) on the basis of "catch all controls for Non-Proliferation of Weapons of Mass Destruction.