

N-Channel Enhancement Mode Power MOSFET

Description

The 8205A uses advanced trench technology to provide excellent $R_{DS(ON)}$, low gate charge and operation with gate voltages as low as 2.5V. This device is suitable for use as a Battery protection or in other Switching application.

General Features

- $V_{DS} = 19.5V, I_D = 6A$
 $R_{DS(ON)} < 37m\Omega @ V_{GS}=2.5V$
 $R_{DS(ON)} < 27m\Omega @ V_{GS}=4.5V$
- High Power and current handing capability
- Lead free product is acquired
- Surface Mount Package

Application

- Battery protection
- Load switch
- Power management

8205A

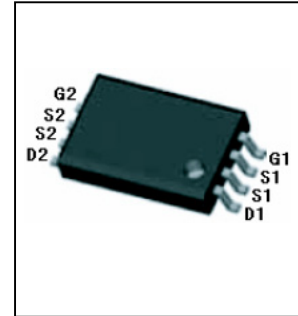

TSSOP-8 top view



pin Assignment

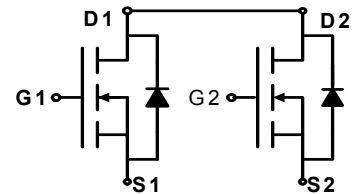

Schematic diagram

Absolute Maximum Ratings (TA=25°C unless otherwise noted)

| Parameter | Symbol | Limit | Unit |
|--|----------------|------------|------|
| Drain-Source Voltage | V_{DS} | 19.5 | V |
| Gate-Source Voltage | V_{GS} | ± 10 | V |
| Drain Current-Continuous | I_D | 6 | A |
| Drain Current-Pulsed (Note 1) | I_{DM} | 25 | A |
| Maximum Power Dissipation | P_D | 1.5 | W |
| Operating Junction and Storage Temperature Range | T_J, T_{STG} | -55 To 150 | °C |

Thermal Characteristic

| | | | |
|--|-----------------|----|------|
| Thermal Resistance, Junction-to-Ambient (Note 2) | $R_{\theta JA}$ | 83 | °C/W |
|--|-----------------|----|------|

Electrical Characteristics (TA=25°C unless otherwise noted)

| Parameter | Symbol | Condition | Min | Typ | Max | Unit |
|---------------------------------|------------|---------------------------|------|-----|-----|---------|
| Off Characteristics | | | | | | |
| Drain-Source Breakdown Voltage | BV_{DSS} | $V_{GS}=0V, I_D=250\mu A$ | 19.5 | 21 | | V |
| Zero Gate Voltage Drain Current | I_{DSS} | $V_{DS}=19.5V, V_{GS}=0V$ | | | 1 | μA |

8205A

| | | | | | | |
|---|--------------|--|-----|------|-----------|------------|
| Gate-Body Leakage Current | I_{GSS} | $V_{GS}=\pm 10V, V_{DS}=0V$ | | | ± 100 | nA |
| On Characteristics (Note 3) | | | | | | |
| Gate Threshold Voltage | $V_{GS(th)}$ | $V_{DS}=V_{GS}, I_D=250\mu A$ | 0.5 | 0.7 | 1.2 | V |
| Drain-Source On-State Resistance | $R_{DS(ON)}$ | $V_{GS}=4.5V, I_D=4.5A$ | | 21 | 27 | m Ω |
| | | $V_{GS}=2.5V, I_D=3.5A$ | | 27 | 37 | m Ω |
| Forward Transconductance | g_{FS} | $V_{DS}=5V, I_D=4.5A$ | | 10 | | S |
| Dynamic Characteristics (Note4) | | | | | | |
| Input Capacitance | C_{ISS} | $V_{DS}=8V, V_{GS}=0V,$ $F=1.0MHz$ | | 600 | | PF |
| Output Capacitance | C_{OSS} | | | 330 | | PF |
| Reverse Transfer Capacitance | C_{RSS} | | | 140 | | PF |
| Switching Characteristics (Note 4) | | | | | | |
| Turn-on Delay Time | $t_{d(on)}$ | $V_{DD}=10V, I_D=1A$ $V_{GS}=4.5V, R_{GEN}=6\Omega$ | | 10 | 20 | nS |
| Turn-on Rise Time | t_r | | | 11 | 25 | nS |
| Turn-Off Delay Time | $t_{d(off)}$ | | | 35 | 70 | nS |
| Turn-Off Fall Time | t_f | | | 30 | 60 | nS |
| Total Gate Charge | Q_g | $V_{DS}=10V, I_D=6A,$ $V_{GS}=4.5V$ | | 10 | 15 | nC |
| Gate-Source Charge | Q_{gs} | | | 2.3 | | nC |
| Gate-Drain Charge | Q_{gd} | | | 1.5 | | nC |
| Drain-Source Diode Characteristics | | | | | | |
| Diode Forward Voltage (Note 3) | V_{SD} | $V_{GS}=0V, I_S=1.7A$ | | 0.75 | 1.2 | V |
| Diode Forward Current (Note 2) | I_S | | | | 1.7 | A |

Notes:

1. Repetitive Rating: Pulse width limited by maximum junction temperature.
2. Surface Mounted on FR4 Board, $t \leq 10$ sec.
3. Pulse Test: Pulse Width $\leq 300\mu s$, Duty Cycle $\leq 2\%$.
4. Guaranteed by design, not subject to production

8205A

TYPICAL ELECTRICAL AND THERMAL CHARACTERISTICS

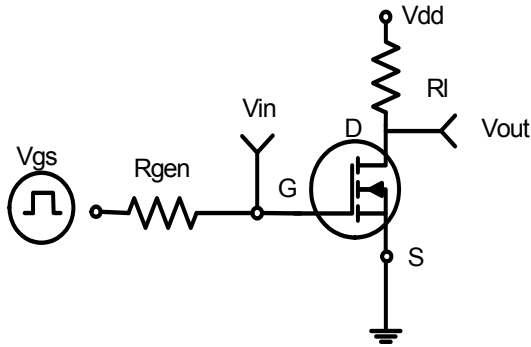

Figure 1: Switching Test Circuit

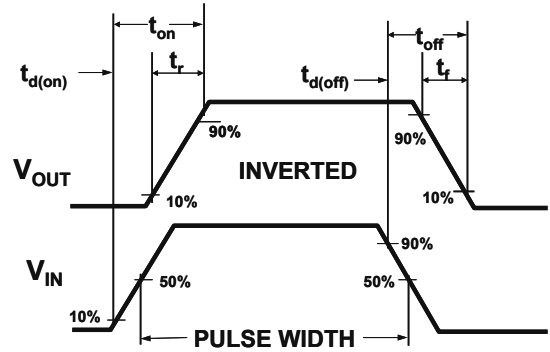

Figure 2: Switching Waveforms

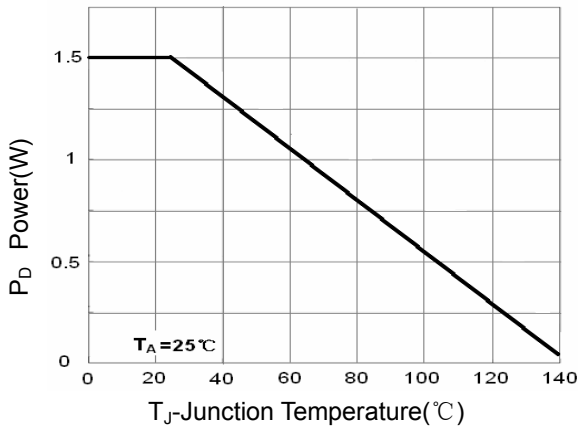

Figure 3 Power Dissipation

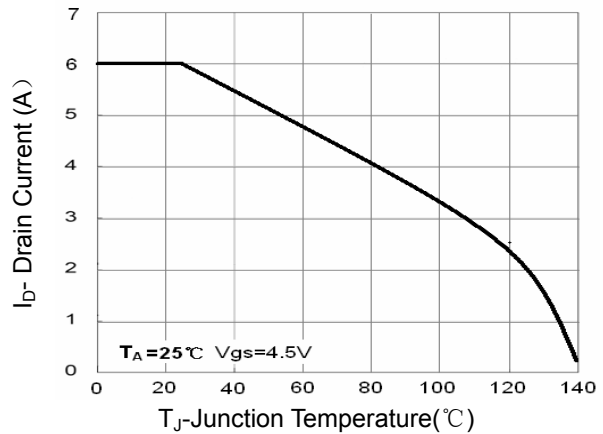

Figure 4 Drain Current

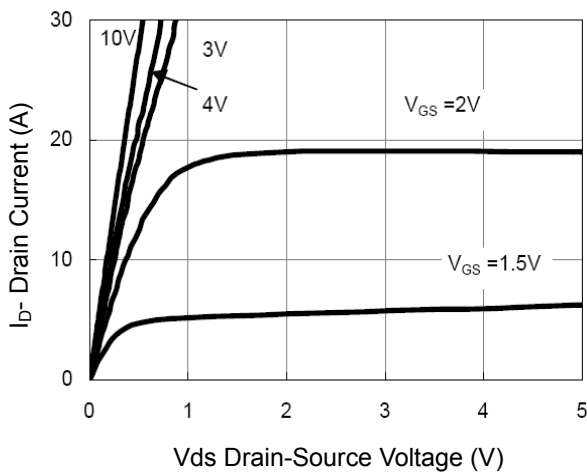

Figure 5 Output CHARACTERISTICS

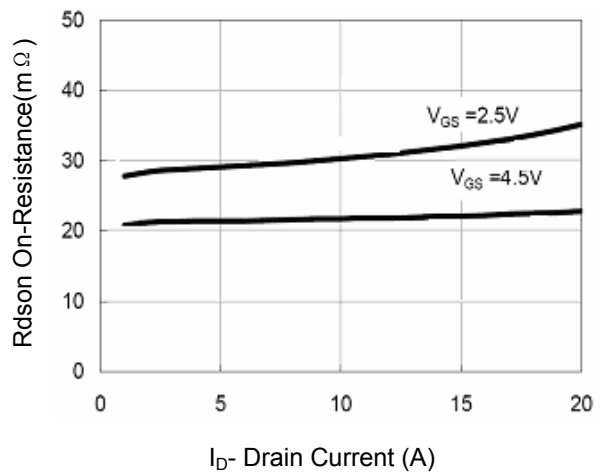

Figure 6 Drain-Source On-Resistance

8205A

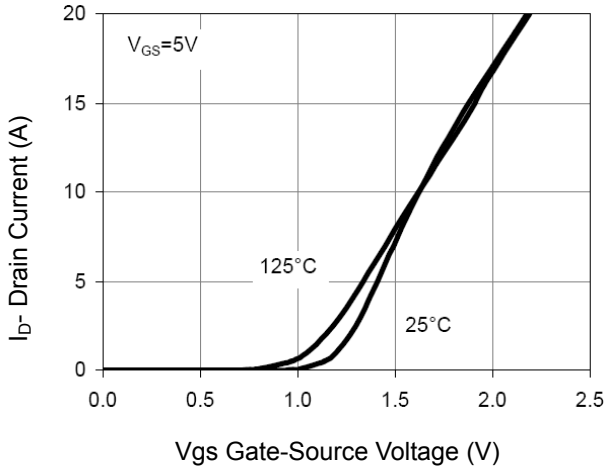

Figure 7 Transfer Characteristics

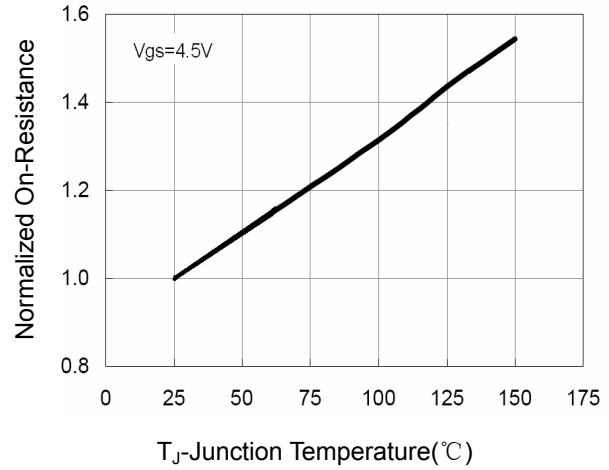

Figure 8 Drain-Source On-Resistance

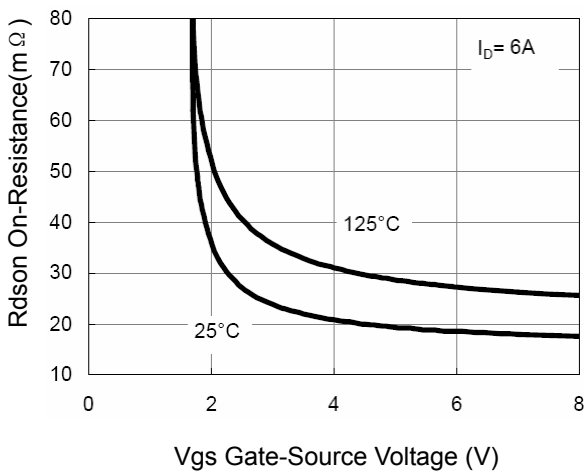

Figure 9 Rdson vs Vgs

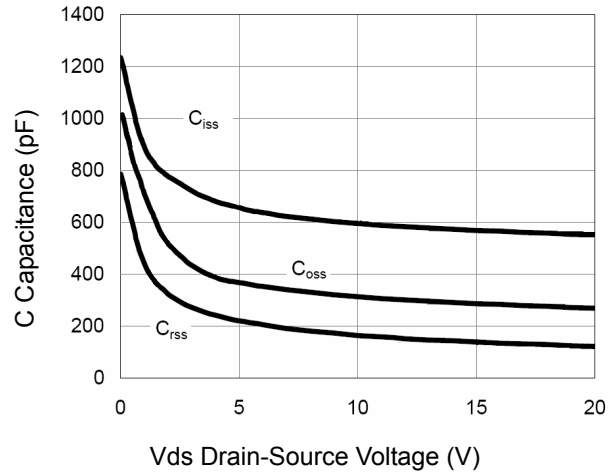

Figure 10 Capacitance vs Vds

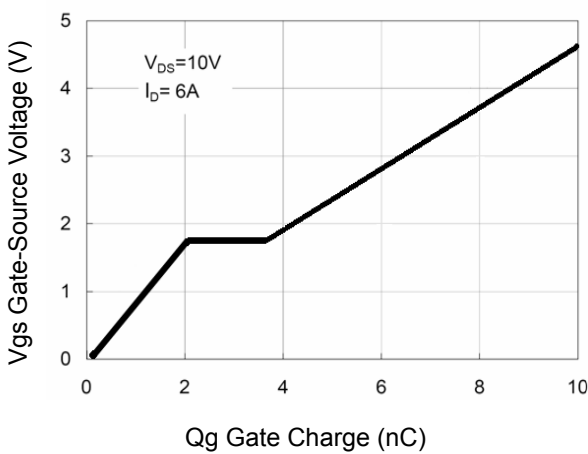

Figure 11 Gate Charge

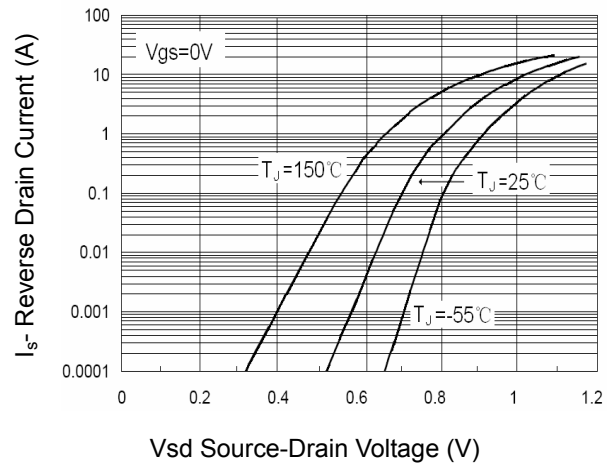

Figure 12 Source- Drain Diode Forward

8205A

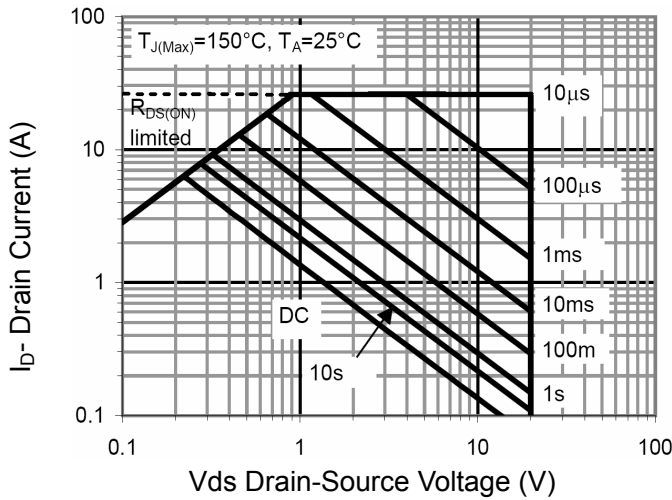

Figure 13 Safe Operation Area

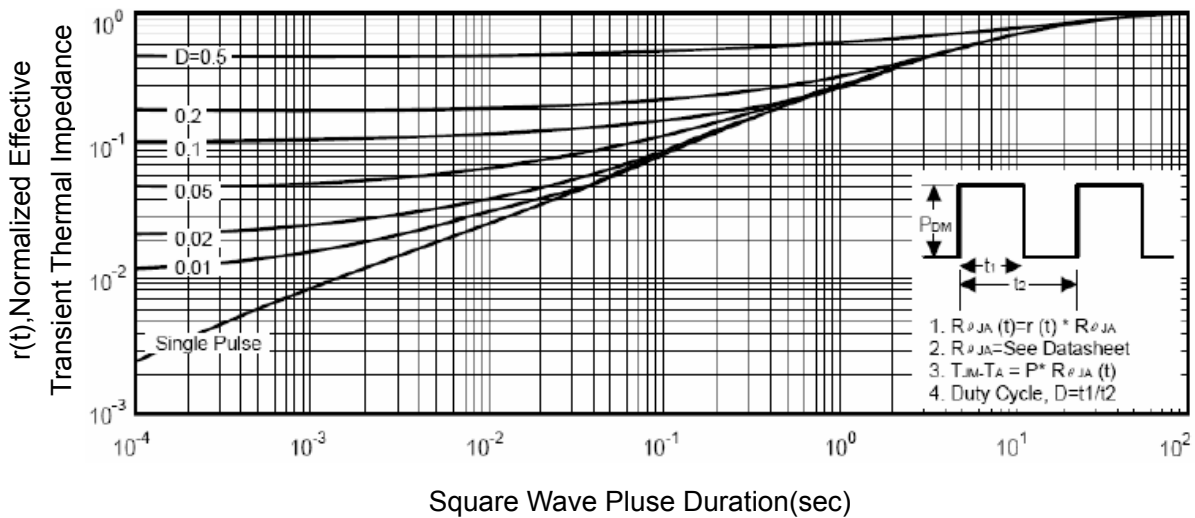

Figure 14 Normalized Maximum Transient Thermal Impedance