

2,097,152 WORDS X 32 BIT DYNAMIC RAM MODULE

PRELIMINARY

DESCRIPTION

The THM322020S is a 2,097,152 words by 32 bits dynamic RAM module which assembled 16 pcs of TC514400J on the printed circuit board. The THM322020S can be as well used as 4,194,304 words by 16 bits dynamic RAM module, by means of connecting DQ0 and DQ16, DQ1 and DQ17, DQ2 and DQ18, ..., DQ15 and DQ31, respectively. The THM322020S is optimized for application to the systems which are required high density and large capacity such as main memory of the computers and as image memory systems, and to the others which are requested compact size.

FEATURES

- 2,097,152 words by 32 bits organization
- Fast access time and cycle time
- Single power supply of 5V ±10%
- Low Power
  - 4,708mW MAX. Operating (THMxxxxxx-80)
  - 4,048mW MAX. Operating (THMxxxxxx-10)
  - 88mW MAX. Standby
- $\overline{\text{CAS}}$  before  $\overline{\text{RAS}}$  refresh,  $\overline{\text{RAS}}$  only refresh, Hidden refresh, and Fast Page Mode capability.
- All inputs and outputs TTL compatible.
- 1024 Refresh cycles/16ms
- Tin-Lead Contact : THM322020S-80, 10
- Gold Contact : THM322020SG-80, 10

		THM322020 S-80	THM322020 S-10
$t_{\text{RAC}}$	RAS Access Time	80ns	100ns
$t_{\text{AA}}$	Column Address Access Time	40ns	50ns
$t_{\text{CAC}}$	$\overline{\text{CAS}}$ Access Time	20ns	25ns
$t_{\text{RC}}$	Cycle Time	150ns	180ns
$t_{\text{PC}}$	Fast Page Mode Cycle Time	50ns	60ns

PIN CONNECTION (TOP VIEW)

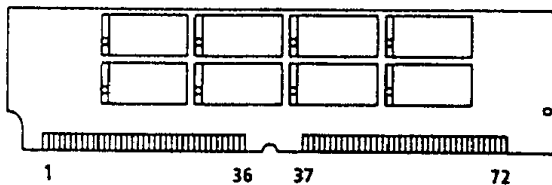

PIN NAMES

A0~A9	Address Inputs
DQ0~DQ31	Data Input/Output
$\overline{\text{CAS0}}-\overline{\text{CAS3}}$	Column Address Strobe
$\overline{\text{RAS0}}-\overline{\text{RAS3}}$	Row Address Strobe
$\overline{\text{W}}$	Read/Write Input
$V_{\text{CC}}$	Power (+ 5V)
$V_{\text{SS}}$	Ground
PD	Presence Detect Pin

1	$V_{\text{SS}}$	13	A1	25	DQ22	37	NC	49	DQ8	61	DQ13
2	DQ0	14	A2	26	DQ7	38	NC	50	DQ24	62	DQ30
3	DQ16	15	A3	27	DQ23	39	$V_{\text{SS}}$	51	DQ9	63	DQ14
4	DQ1	16	A4	28	A7	40	$\overline{\text{CAS0}}$	52	DQ25	64	DQ31
5	DQ17	17	A5	29	NC	41	$\overline{\text{CAS2}}$	53	DQ10	65	DQ15
6	DQ2	18	A6	30	$V_{\text{CC}}$	42	$\overline{\text{CAS3}}$	54	DQ26	66	NC
7	DQ18	19	NC	31	A8	43	$\overline{\text{CAS1}}$	55	DQ11	67	PD0
8	DQ3	20	DQ4	32	A9	44	$\overline{\text{RAS0}}$	56	DQ27	68	PD1
9	DQ19	21	DQ20	33	$\overline{\text{RAS3}}$	45	$\overline{\text{RAS1}}$	57	DQ12	69	PD2
10	$V_{\text{CC}}$	22	DQ5	34	$\overline{\text{RAS2}}$	46	NC	58	DQ28	70	PD3
11	NC	23	DQ21	35	NC	47	$\overline{\text{W}}$	59	$V_{\text{CC}}$	71	NC
12	A0	24	DQ6	36	NC	48	NC	60	DQ29	72	$V_{\text{SS}}$

	- 80	- 10
PD0	NC	NC
PD1	NC	NC
PD2	NC	$V_{\text{SS}}$
PD3	$V_{\text{SS}}$	$V_{\text{SS}}$

# THM322020S-80, 10 THM322020SG-80, 10

## BLOCK DIAGRAM

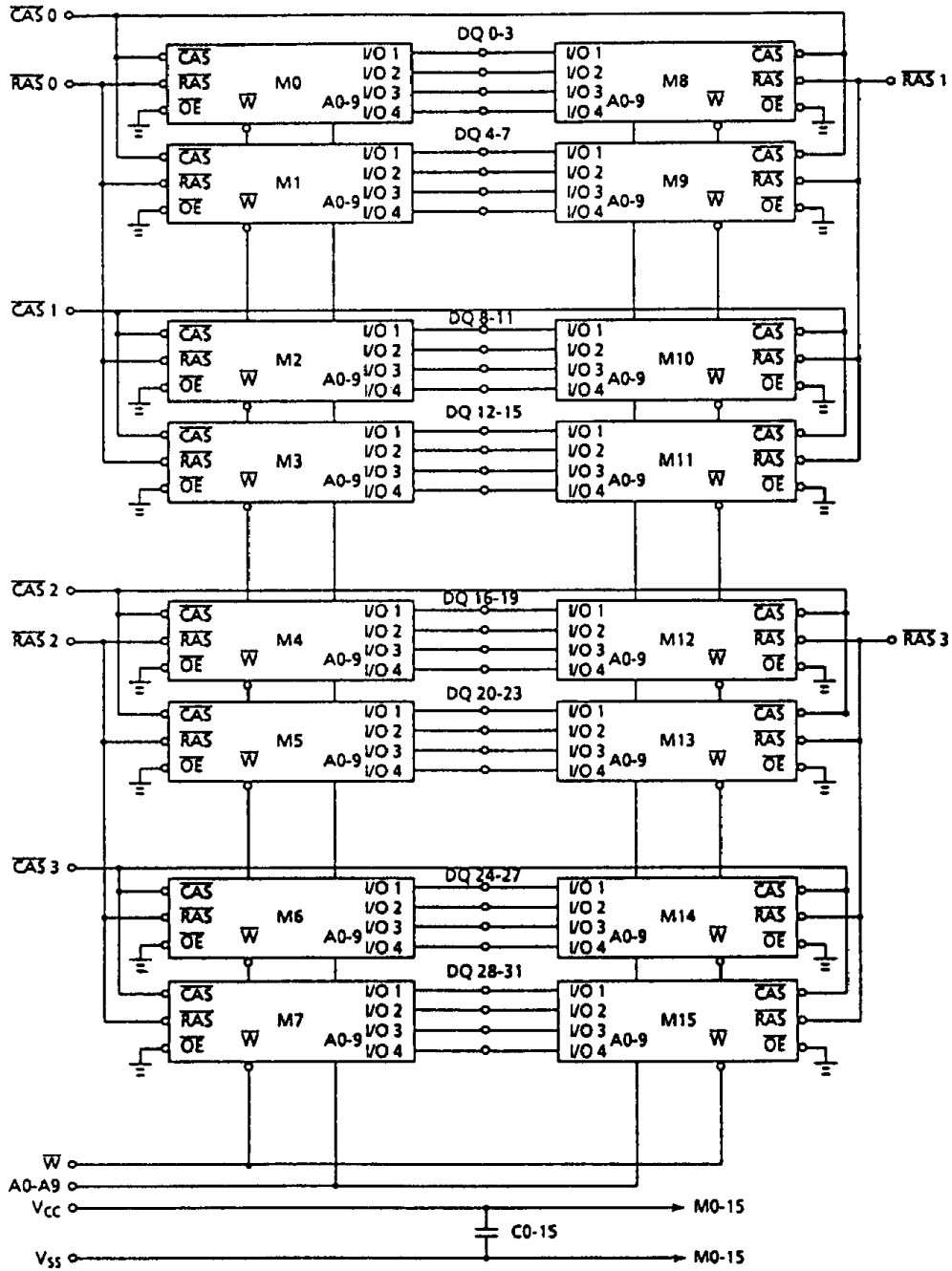

ABSOLUTE MAXIMUM RATINGS

ITEM	SYMBOL	RATING	UNITS	NOTES
Input Voltage	$V_{IH}$	-1.0~7.0	V	1
Output Voltage	$V_{OUT}$	-1.0~7.0	V	1
Power Supply Voltage	$V_{CC}$	-1.0~7.0	V	1
Operating Temperature	$T_{OPR}$	0~70	°C	1
Storage Temperature	$T_{STG}$	-55~125	°C	1
Soldering Temperature · Time	$T_{SOLDER}$	260 · 10	°C · sec	1
Power Dissipation	$P_D$	7.2	W	1
Short Circuit Output Current	$I_{OUT}$	50	mA	1

RECOMMENDED DC OPERATING CONDITIONS ( $T_a = 0 \sim 70^\circ\text{C}$ )

SYMBOL	PARAMETER	MIN.	TYP.	MAX.	UNIT	NOTES
$V_{CC}$	Supply Voltage	4.5	5.0	5.5	V	2
$V_{IH}$	Input High Voltage	2.4	-	6.5	V	2
$V_{IL}$	Input Low Voltage	-1.0	-	0.8	V	2

# THM322020S-80, 10

## THM322020SG-80, 10

### DC ELECTRICAL CHARACTERISTICS ( $V_{CC} = 5V \pm 10\%$ , $T_a = 0\sim 70^\circ C$ )

SYMBOL	PARAMETER	MIN.	MAX.	UNITS	NOTES	
I <sub>CC1</sub>	OPERATING CURRENT					
	Average Power Supply Operating Current ( $\overline{RAS}$ , $\overline{CAS}$ , Address Cycling: $t_{RC} = t_{RC} \text{ MIN.}$ )	THM322020S-80	-	856	mA	3, 4
		THM322020S-10	-	736		
I <sub>CC2</sub>	STANDBY CURRENT Power Supply Standby Current ( $\overline{RAS} = \overline{CAS} = V_{IH}$ )	-	32	mA		
I <sub>CC3</sub>	$\overline{RAS}$ ONLY REFRESH CURRENT					
	Average Power Supply Current, $\overline{RAS}$ Only Mode ( $\overline{RAS}$ Cycling, $\overline{CAS} = V_{IH}$ ; $t_{RC} = t_{RC} \text{ MIN.}$ )	THM322020S-80	-	856	mA	3
		THM322020S-10	-	736		
I <sub>CC4</sub>	FAST PAGE MODE CURRENT					
	Average Power Supply Current, Fast Page Mode ( $\overline{RAS} = V_{IL}$ , $\overline{CAS}$ Address Cycling: $t_{PC} = t_{PC} \text{ MIN.}$ )	THM322020S-80	-	576	mA	3, 4
		THM322020S-10	-	496		
I <sub>CC5</sub>	STANDBY CURRENT Power Supply Standby Current ( $\overline{RAS} = \overline{CAS} = V_{CC} - 0.2V$ )	-	16	mA		
I <sub>CC6</sub>	$\overline{CAS}$ BEFORE $\overline{RAS}$ REFRESH CURRENT					
	Average Power Supply Current, $\overline{CAS}$ Before $\overline{RAS}$ Mode ( $\overline{RAS}$ , $\overline{CAS}$ Cycling: $t_{RC} = t_{RC} \text{ MIN.}$ )	THM322020S-80	-	856	mA	3
		THM322020S-10	-	736		
I <sub>I(L)</sub>	INPUT LEAKAGE CURRENT Input Leakage Current, any Input ( $0V \leq V_{IN} \leq 6.5V$ , All Other Pins not under Test = $0V$ )	- 160	160	$\mu A$		
I <sub>O(L)</sub>	OUTPUT LEAKAGE CURRENT ( $O_{OUT}$ is disabled, $0V \leq V_{OUT} \leq 5.5V$ )	- 20	20	$\mu A$		
I <sub>OH</sub>	OUTPUT LEVEL Output "H" Level Voltage ( $I_{OUT} = -5mA$ )	2.4	-	V		
V <sub>OL</sub>	OUTPUT LEVEL Output "L" Level Voltage ( $I_{OUT} = 4.2mA$ )	-	0.4	V		

ELECTRICAL CHARACTERISTICS AND RECOMMENDED AC OPERATING CONDITIONS  
( $V_{CC} = 5V \pm 10\%$ ,  $T_a = 0 \sim 70^\circ C$ ) (Notes 5, 6, 7)

SYMBOL	PARAMETER	THM322020S-80		THM322020S-10		UNIT	NOTES
		MIN.	MAX.	MIN.	MAX.		
$t_{RC}$	Random Read or Write Cycle Time	150	-	180	-	ns	
$t_{PC}$	Fast Page Mode Cycle Time	50	-	60	-	ns	
$t_{RAC}$	Access Time from $\overline{RAS}$	-	80	-	100	ns	8, 13
$t_{CAC}$	Access Time from $\overline{CAS}$	-	20	-	25	ns	8, 13
$t_{AA}$	Access Time from Column Address	-	40	-	50	ns	8, 14
$t_{CPA}$	Access Time from $\overline{CAS}$ Precharge	-	45	-	55	ns	8
$t_{CLZ}$	$\overline{CAS}$ to Output in Low-Z	0	-	0	-	ns	8
$t_{OFF}$	Output Buffer Turn-off Delay	0	20	0	20	ns	9
$t_T$	Transition Time (Rise and Fall)	3	50	3	50	ns	7
$t_{RP}$	$\overline{RAS}$ Precharge Time	60	-	70	-	ns	
$t_{RAS}$	$\overline{RAS}$ Pulse Width	80	10,000	100	10,000	ns	
$t_{RASP}$	$\overline{RAS}$ Pulse Width (Fast Page Mode)	80	200,000	100	200,000	ns	
$t_{RSH}$	$\overline{RAS}$ Hold Time	20	-	25	-	ns	
$t_{CSH}$	$\overline{CAS}$ Hold Time	80	-	100	-	ns	
$t_{CAS}$	$\overline{CAS}$ Pulse Width	20	10,000	25	10,000	ns	
$t_{RCD}$	$\overline{RAS}$ to $\overline{CAS}$ Delay Time	20	60	25	75	ns	13
$t_{RAD}$	$\overline{RAS}$ to Column Address Delay Time	15	40	20	50	ns	14
$t_{CRP}$	$\overline{CAS}$ to $\overline{RAS}$ Precharge Time	5	-	10	-	ns	
$t_{CP}$	$\overline{CAS}$ Precharge Time (Fast Page Mode)	10	-	10	-	ns	
$t_{ASR}$	Row Address Set-Up Time	0	-	0	-	ns	
$t_{RAH}$	Row Address Hold Time	10	-	15	-	ns	
$t_{ASC}$	Column Address Set-Up Time	0	-	0	-	ns	
$t_{CAH}$	Column Address Hold Time	15	-	20	-	ns	
$t_{AR}$	Column Address Hold Time referenced to $\overline{RAS}$	60	-	75	-	ns	
$t_{RAL}$	Column Address to $\overline{RAS}$ Lead Time	40	-	50	-	ns	
$t_{RCS}$	Read Command Set-Up Time	0	-	0	-	ns	
$t_{RCH}$	Read Command Hold Time	0	-	0	-	ns	10
$t_{RRH}$	Read Command Hold Time referenced to $\overline{RAS}$	0	-	0	-	ns	10
$t_{WCH}$	Write Command Hold Time	15	-	20	-	ns	
$t_{WCR}$	Write Command Hold Time referenced to $\overline{RAS}$	60	-	75	-	ns	

# THM322020S-80, 10

# THM322020SG-80, 10

## ELECTRICAL CHARACTERISTICS AND RECOMMENDED AC OPERATING CONDITIONS

(Continued)

SYMBOL	PARAMETER	THM322020S-80		THM322020S-10		UNIT	NOTES
		MIN.	MAX.	MIN.	MAX.		
t <sub>WP</sub>	Write Command Pulse Width	15	-	20	-	ns	
t <sub>RWL</sub>	Write Command to $\overline{RAS}$ Lead Time	20	-	25	-	ns	
t <sub>CWL</sub>	Write Command to $\overline{CAS}$ Lead Time	20	-	25	-	ns	
t <sub>DS</sub>	Data Set-Up Time	0	-	0	-	ns	11
t <sub>DH</sub>	Data Hold Time	15	-	20	-	ns	11
t <sub>DHR</sub>	Data Hold Time referenced to $\overline{RAS}$	60	-	75	-	ns	
t <sub>REF</sub>	Refresh Period	-	16	-	16	ms	
t <sub>WCS</sub>	Write Command Set-Up Time	0	-	0	-	ns	12
t <sub>CSR</sub>	$\overline{CAS}$ Set-Up Time ( $\overline{CAS}$ before $\overline{RAS}$ Cycle)	5	-	10	-	ns	
t <sub>CHR</sub>	$\overline{CAS}$ Hold Time ( $\overline{CAS}$ before $\overline{RAS}$ Cycle)	15	-	20	-	ns	
t <sub>RPC</sub>	$\overline{RAS}$ to $\overline{CAS}$ Precharge Time	0	-	0	-	ns	
t <sub>CPT</sub>	$\overline{CAS}$ Precharge Time ( $\overline{CAS}$ before $\overline{RAS}$ Counter Test Cycle)	40	-	50	-	ns	
t <sub>WRP</sub>	WRITE to $\overline{RAS}$ before Precharge Time ( $\overline{CAS}$ before $\overline{RAS}$ Cycle)	10	-	10	-	ns	
t <sub>WRH</sub>	WRITE to $\overline{RAS}$ Hold Time ( $\overline{CAS}$ before $\overline{RAS}$ Cycle)	10	-	10	-	ns	

## CAPACITANCE ( $V_{CC} = 5V \pm 10\%$ , $f = 1MHz$ , $T_a = 0 \sim 70^\circ C$ )

SYMBOL	PARAMETER	MIN.	MAX.	UNIT
C11	Input Capacitance (A0-A9)	-	161	pF
C12	Input Capacitance ( $\overline{V}$ )	-	168	pF
C13	Input Capacitance ( $\overline{RAS0} \sim \overline{RAS3}$ )	-	42	pF
C14	Input Capacitance ( $\overline{CAS0} \sim \overline{CAS3}$ )	-	42	pF
CDQ1	I/O Capacitance (DQ0-31)	-	29	pF

NOTES:

1. Stresses greater than those listed under "Absolute Maximum Ratings" may cause permanent damage to the device.
2. All voltages are referenced to  $V_{SS}$ .
3.  $I_{CC1}$ ,  $I_{CC3}$ ,  $I_{CC4}$ ,  $I_{CC6}$  depend on cycle rate.
4.  $I_{CC1}$ ,  $I_{CC4}$  depend on output loading. Specified values are obtained with the output open.
5. An initial pause of 200 $\mu$ s is required after power-up followed by 8  $\overline{RAS}$  cycles before proper device operation is achieved. In case of using internal refresh counter, a minimum of 8  $\overline{CAS}$  before  $\overline{RAS}$  initialization cycles instead of 8  $\overline{RAS}$  cycles are required.
6. AC measurements assume  $t_T=5$ ns.
7.  $V_{IH}(\text{min.})$  and  $V_{IL}(\text{max.})$  are reference levels for measuring timing of input signals. Also, transition times are measured between  $V_{IH}$  and  $V_{IL}$ .
8. Measured with a load equivalent to 2 TTL loads and 100pF.
9.  $t_{OFF}(\text{max.})$  defines the time at which the output achieves the open circuit condition and is not referenced to output voltage levels.
10. Either  $t_{RCH}$  or  $t_{RRH}$  must be satisfied for a read cycle.
11. These parameters are referenced to  $\overline{CAS}$  leading edge.
12.  $t_{WCS}$  is not restrictive operating parameters. This is included the data sheet as electrical characteristics only. If  $t_{WCS} \geq t_{WCS}(\text{min.})$ , the cycle is an early write cycle and data out pin will remain open circuit (high impedance).
13. Operation within the  $t_{RCD}(\text{max.})$  limit insures that  $t_{RAC}(\text{max.})$  can be met.  $t_{RCD}(\text{max.})$  is specified as a reference point only: If  $t_{RCD}$  is greater than the specified  $t_{RCD}(\text{max.})$  limit, then access time is controlled by  $t_{CAC}$ .
14. Operation within the  $t_{RAD}(\text{max.})$  limit, insures that  $t_{RAC}(\text{max.})$  can be met.  $t_{RAD}(\text{max.})$  is specified as a reference point only: If  $t_{RAD}$  is greater than the specified  $t_{RAD}(\text{max.})$  limit, then access time is controlled by  $t_{AA}$ .

**THM322020S-80, 10**  
**THM322020SG-80, 10**

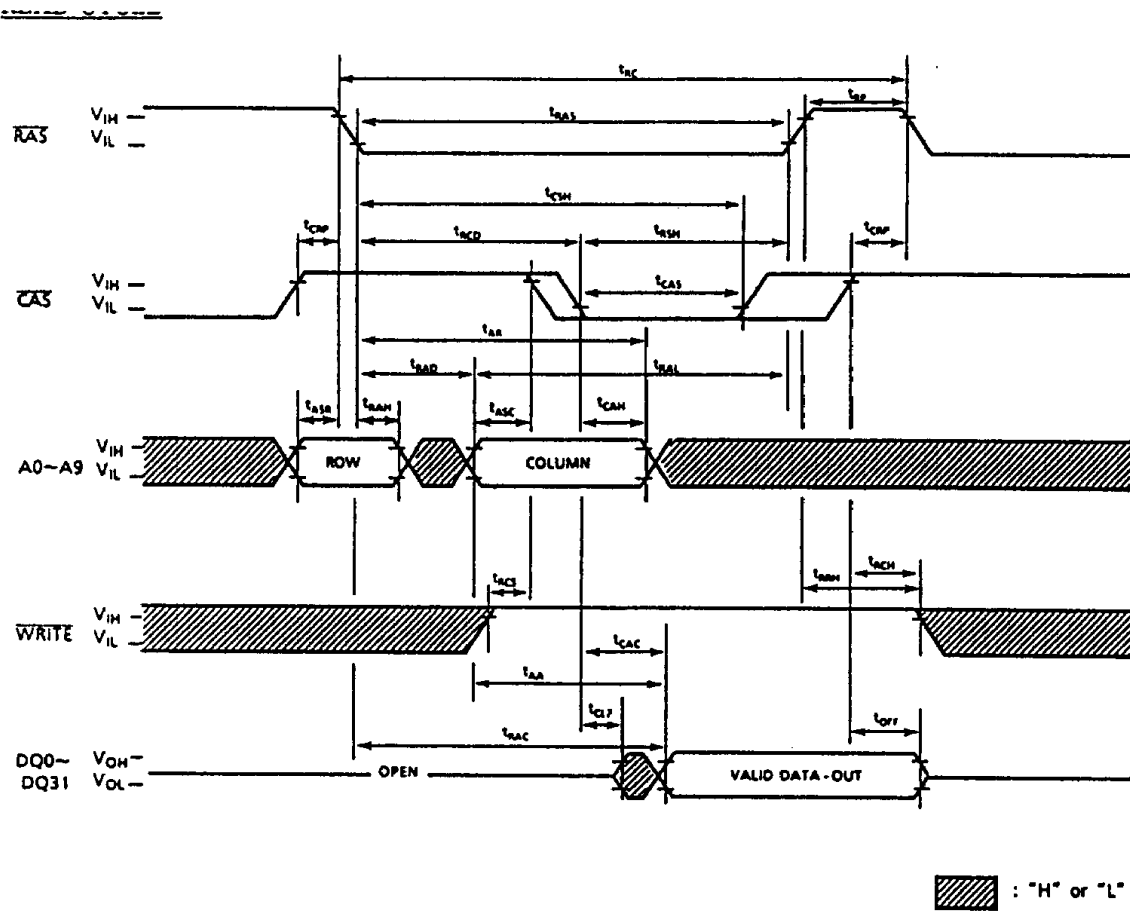



EARLY WRITE CYCLE

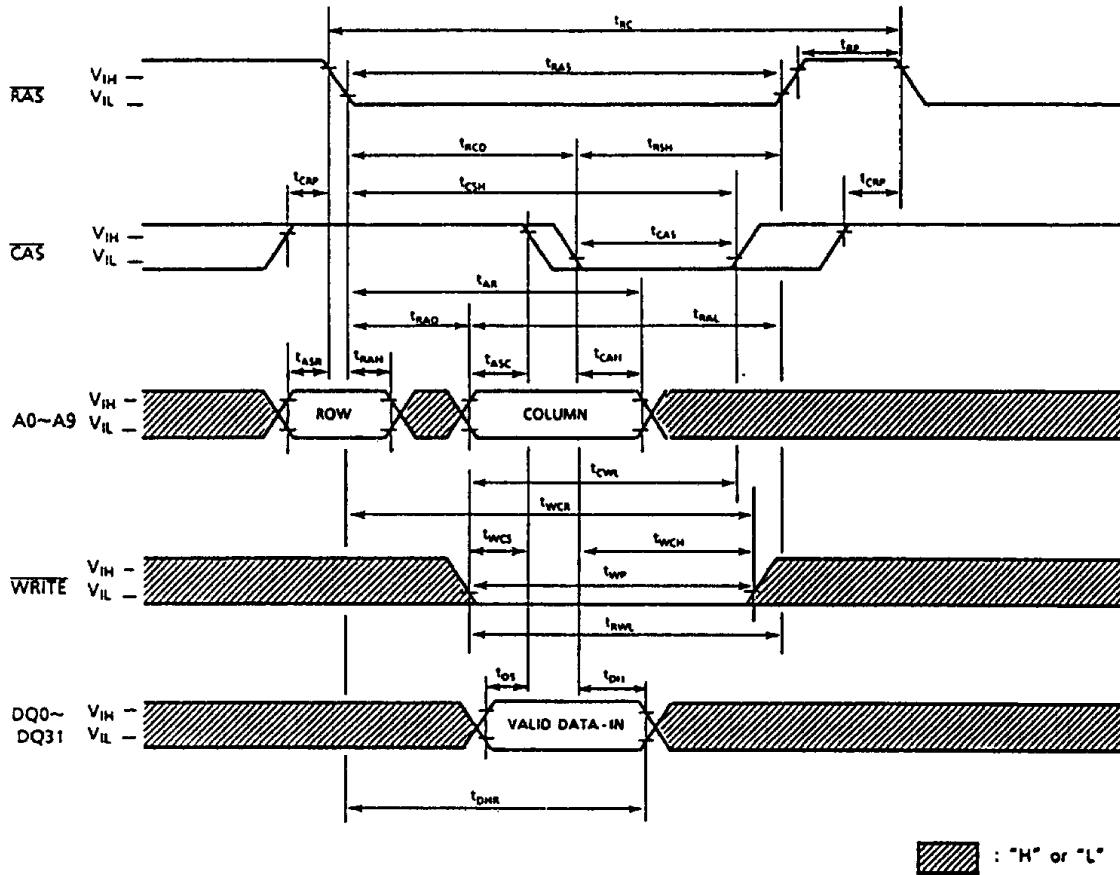

# THM322020S-80, 10

# THM322020SG-80, 10

## FAST PAGE MODE READ CYCLE

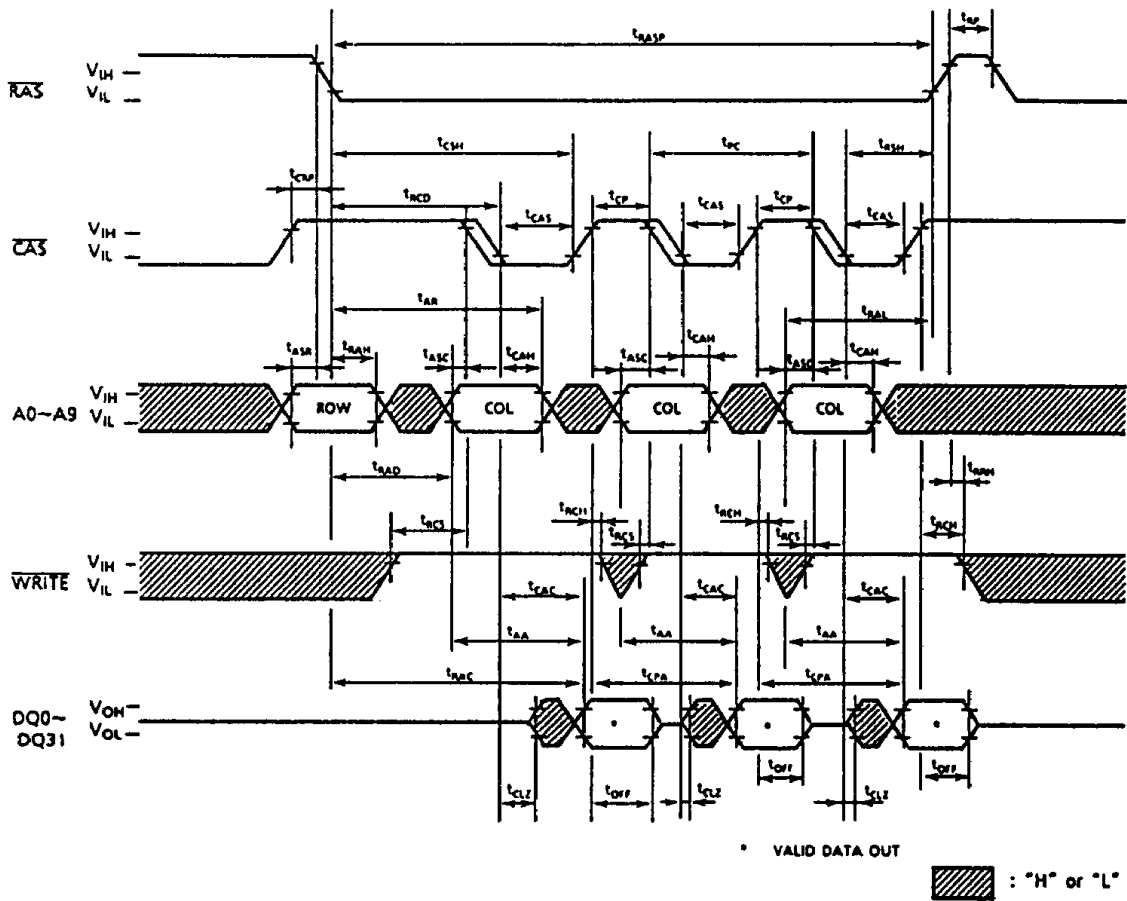

FAST PAGE MODE WRITE CYCLE (EARLY WRITE)

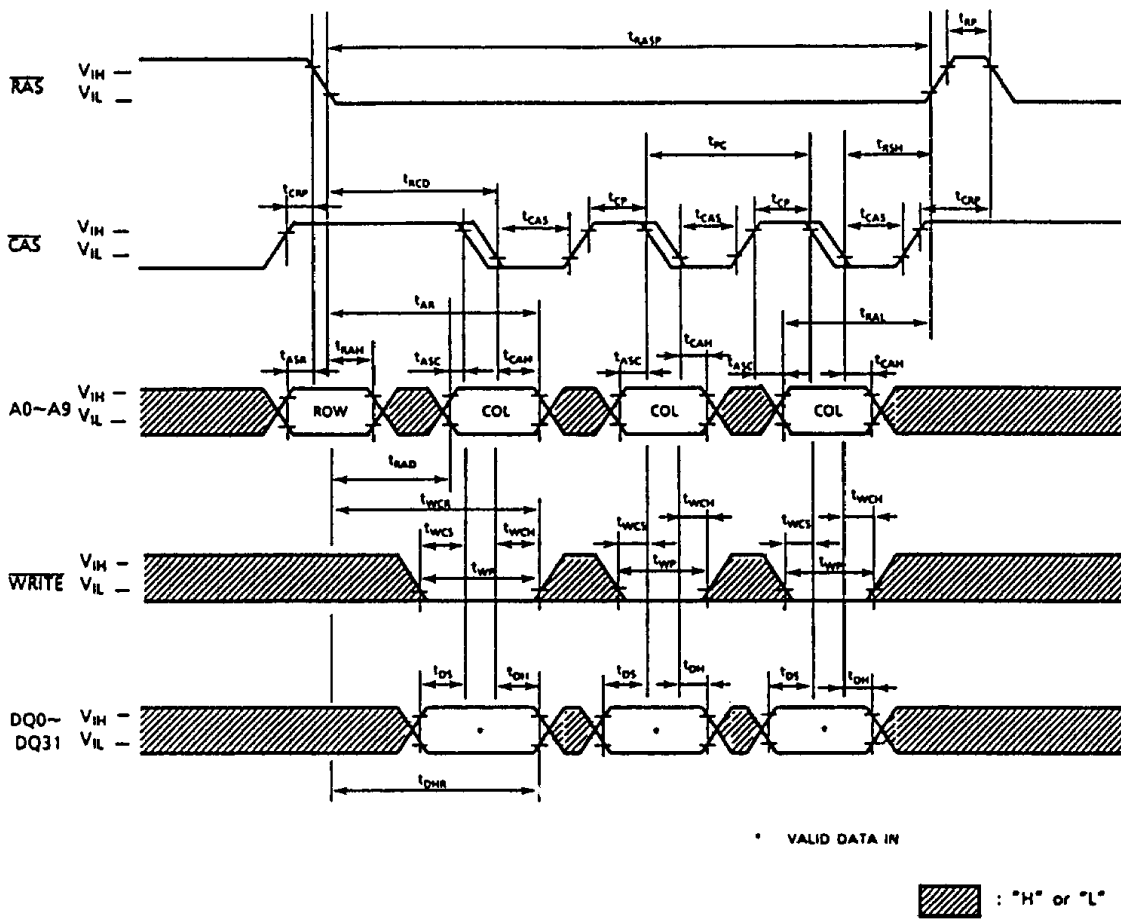

# THM322020S-80, 10

# THM322020SG-80, 10

## RAS ONLY REFRESH CYCLE

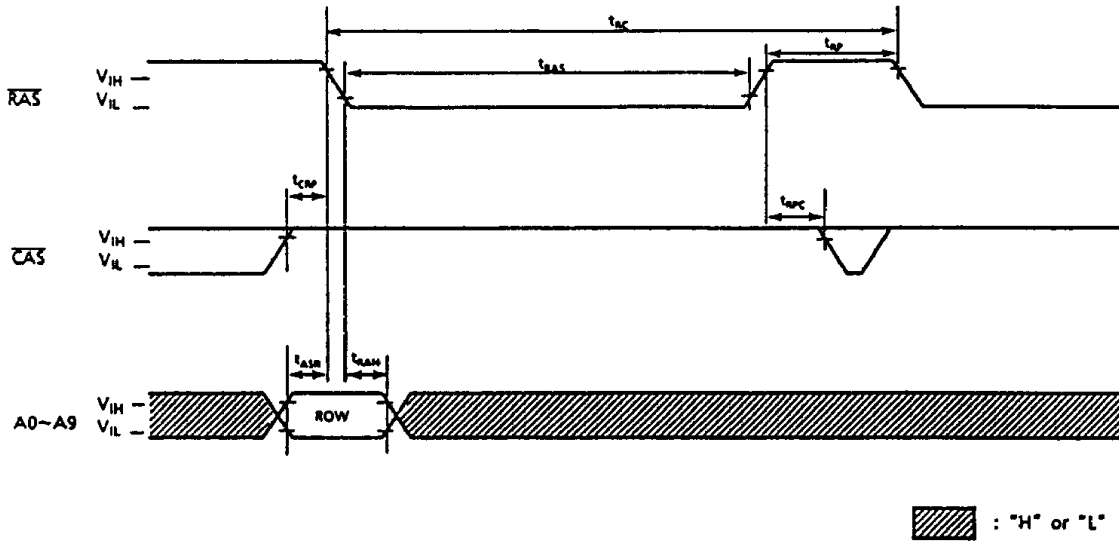

Note: WRITE = "H" or "L"

CAS BEFORE RAS REFRESH CYCLE

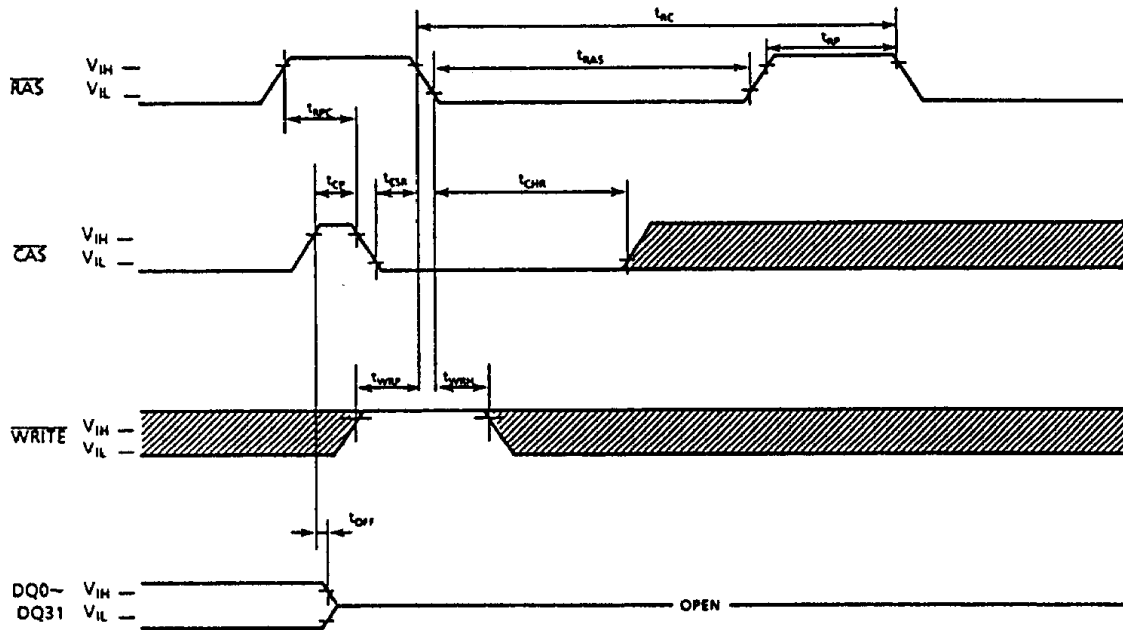

 : "H" or "L"

Note: A0~A9 = "H" or "L"

# THM322020S-80, 10

# THM322020SG-80, 10

## HIDDEN REFRESH CYCLE (READ)

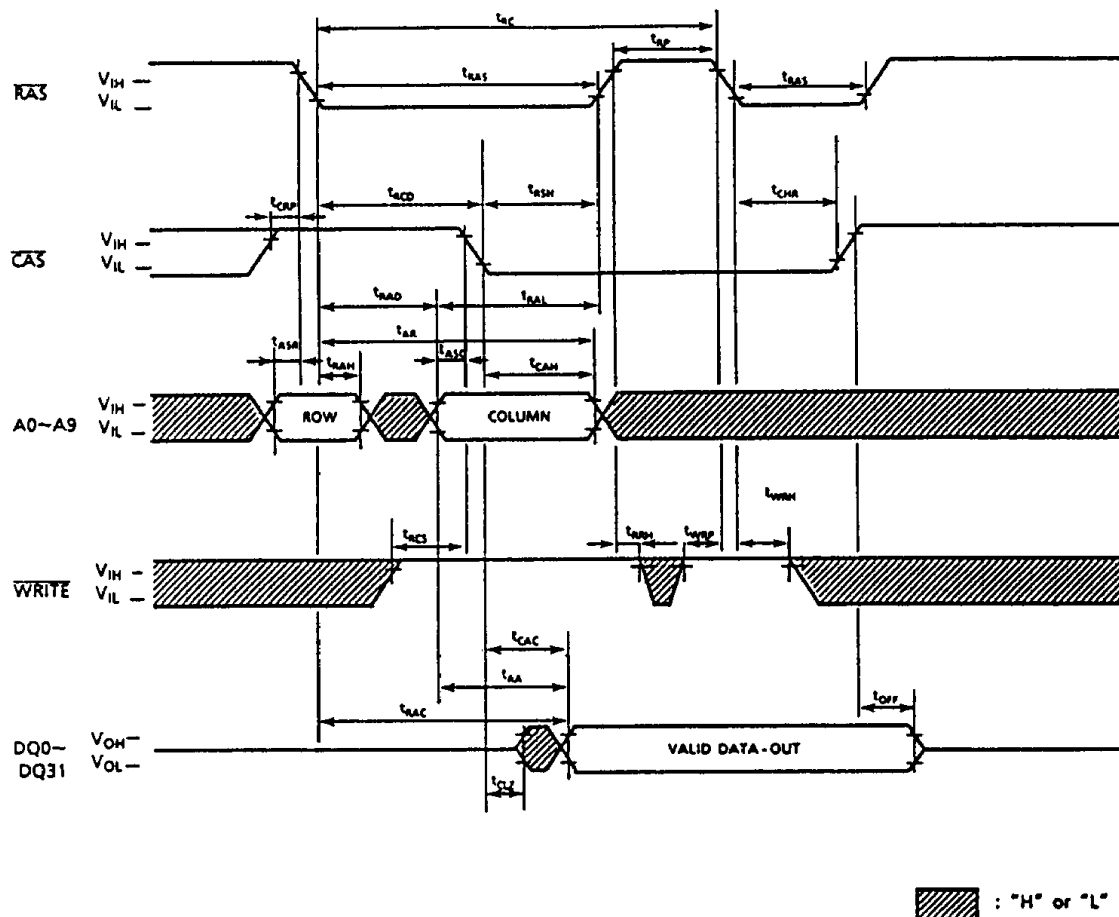

HIDDEN REFRESH CYCLE (WRITE)

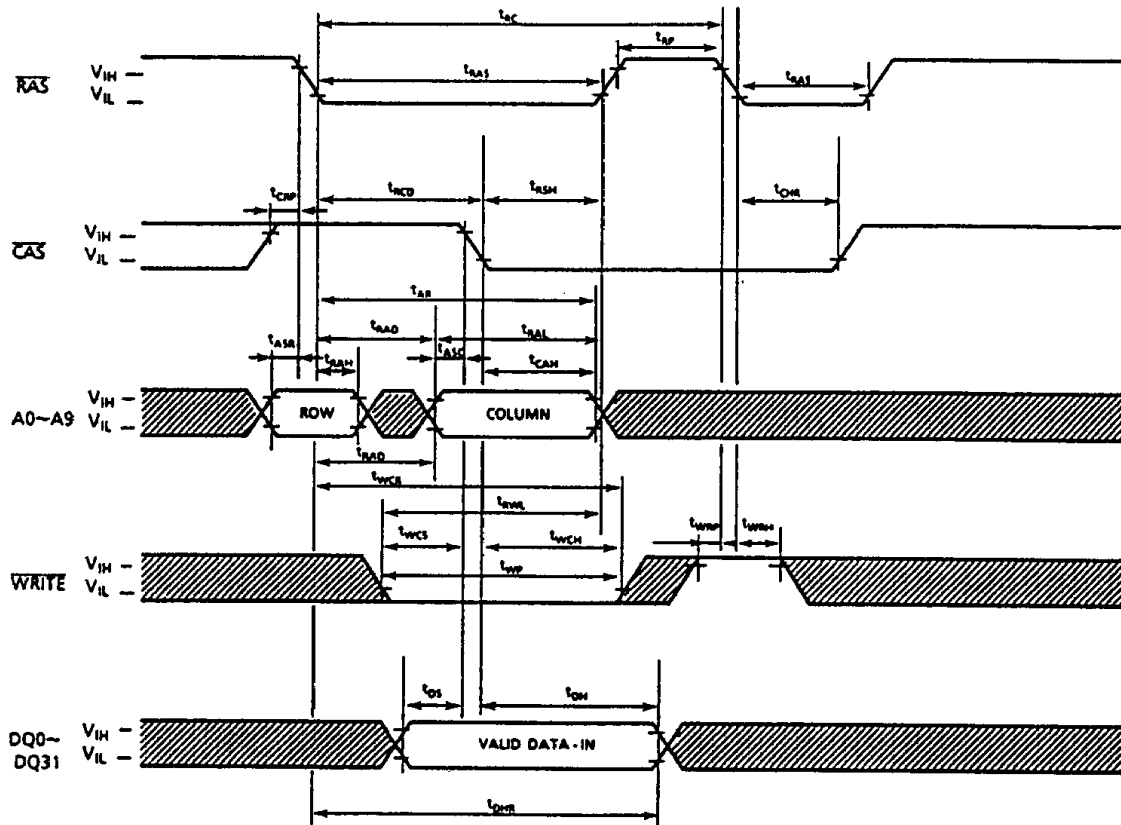

▨ : "H" or "L"

# THM322020S-80, 10

# THM322020SG-80, 10

## CAS BEFORE RAS REFRESH COUNTER TEST CYCLE

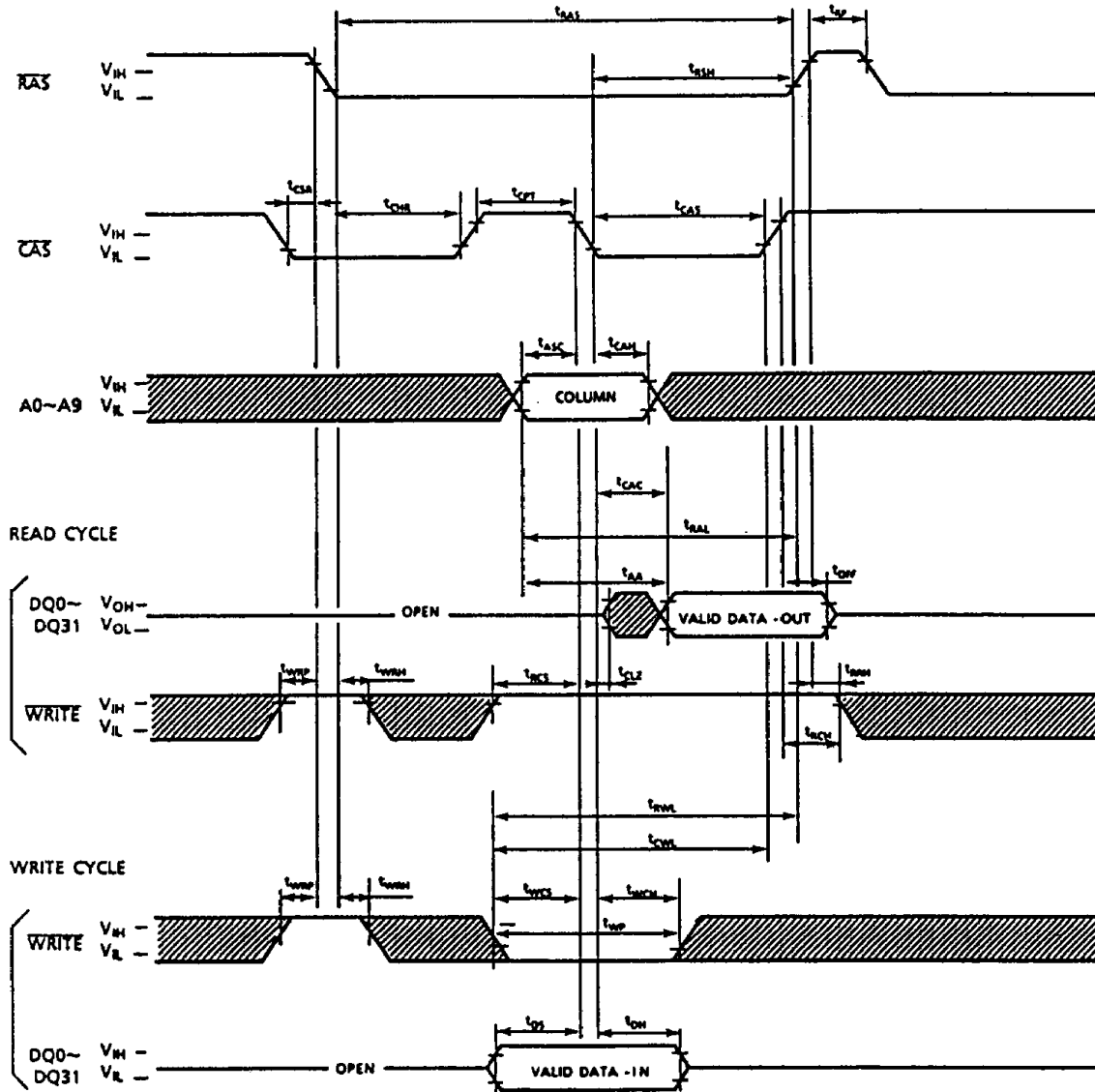

▨ : "H" or "L"



# THM322020S-80, 10 THM322020SG-80, 10

## OUTLINE DRAWINGS

FRONT SIDE

Unit in mm

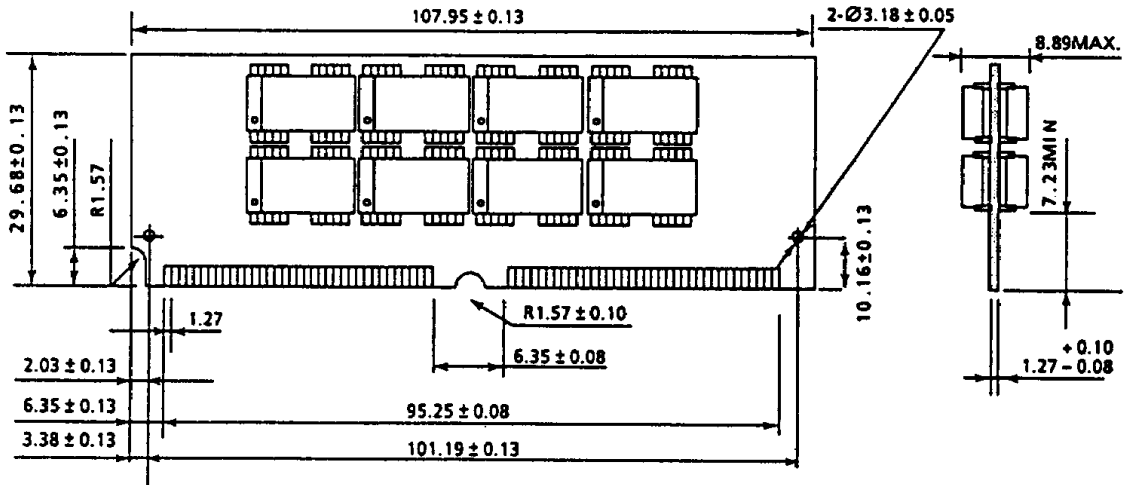

BACK SIDE

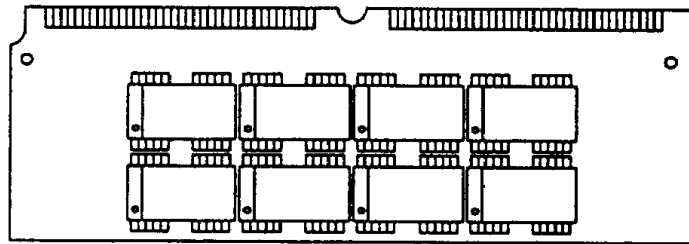

• THM322020S

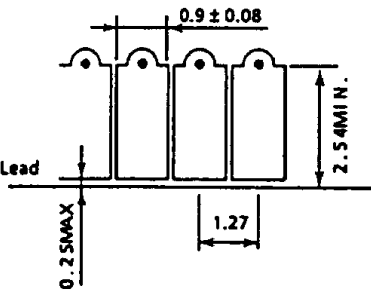

• THM322020SG

