



MMBT5401

PNP EPITAXIAL SILICON TRANSISTOR

HIGH VOLTAGE SWITCHING TRANSISTOR

■ FEATURES

- *Collector-Emitter Voltage: $V_{CE0}=-150V$
- *Collector Dissipation: $P_c(max)=350mW$
- *High current gain

■ MARKING

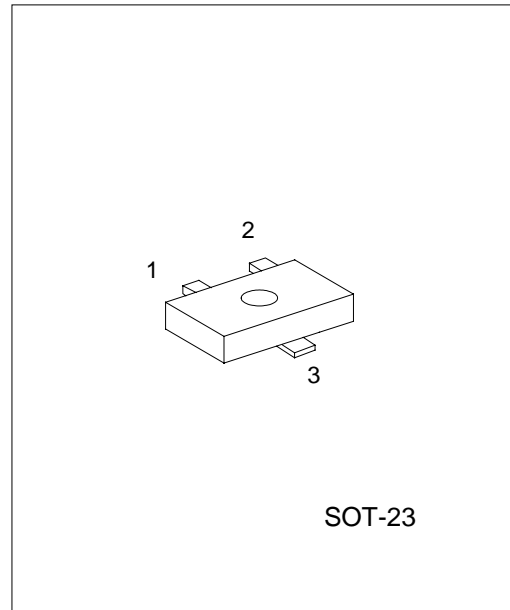
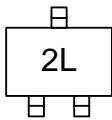

*Pb-free plating product number:MMBT5401L

■ PIN CONFIGURATION

PIN NO.	PIN NAME
1	Emitter
2	Base
3	Collector

■ ORDERING INFORMATION

Order Number		Package	Packing
Normal	Lead free		
MMBT5401-AE3-R	MMBT5401L-AE3-R	SOT-23	Tape Reel

MMBT5401

PNP EPITAXIAL SILICON TRANSISTOR

■ ABSOLUTE MAXIMUM RATINGS (Ta = 25°C)

PARAMETER	SYMBOL	RATINGS	UNIT
Collector -Base Voltage	V _{CB0}	-160	V
Collector -Emitter Voltage	V _{CE0}	-150	V
Emitter -Base Voltage	V _{EBO}	-5	V
DC Collector Current	I _C	-600	mA
Power Dissipation	P _D	350	mW
Operating Temperature	T _J	+150	°C
Storage Temperature	T _{STG}	-40 ~ +150	°C

■ ELECTRICAL CHARACTERISTICS (Ta= 25°C, unless otherwise specified)

PARAMETER	SYMBOL	TEST CONDITIONS	MIN	TYP	MAX	UNIT
Collector-Base Breakdown Voltage	V _{CB0}	I _C =-100μA, I _E =0	-160			V
Collector-Emitter Breakdown Voltage	V _{CE0}	I _C =-1mA, I _B =0	-150			V
Emitter-Base Breakdown Voltage	V _{EBO}	I _E =-10μA, I _C =0	-6			V
Collector Cut-off Current	I _{CBO}	V _{CB} =-120V, I _E =0			-50	nA
Emitter Cut-off Current	I _{EBO}	V _{BE} =-3V, I _C =0			-50	nA
DC Current Gain(note)	h _{FE}	V _{CE} =-5V, I _C =-1mA	80			
		V _{CE} =-5V, I _C =-10mA	80		400	
		V _{CE} =-5V, I _C =-50mA	80			
Collector-Emitter Saturation Voltage	V _{CE(sat)}	I _C =10mA, I _B =1mA I _C =50mA, I _B =5mA			-0.2 -0.5	V
Base-Emitter Saturation Voltage	V _{BE(sat)}	I _C =-10mA, I _B =-1mA I _C =-50mA, I _B =-5mA			1 1	V
Current Gain Bandwidth Product	f _T	V _{CE} =-10V, I _C =-10mA, f=100MHz	100		400	MHz
Output Capacitance	C _{ob}	V _{CB} =-10V, I _E =0, f=1MHz			6.0	pF
Noise Figure	N _F	I _C =-0.25mA, V _{CE} =-5V R _S =1kΩ, f=10Hz ~ 15.7kHz			8	dB

Note: Pulse test: PW<300μs, Duty Cycle<2%

■ CLASSIFICATION OF hFE

RANK	A	B	C
RANGE	80-170	150-240	200-400

■ TYPICAL CHARACTERISTICS

Fig.1 Collector output Capacitance

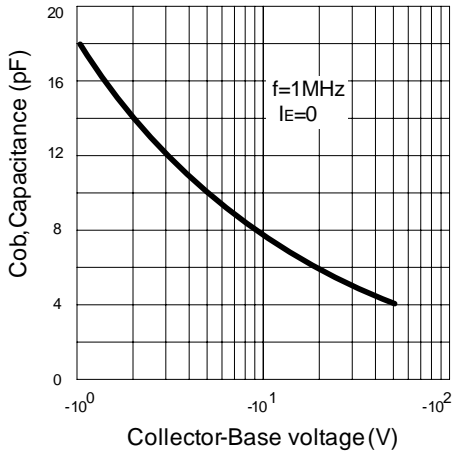

Fig.2 DC current Gain

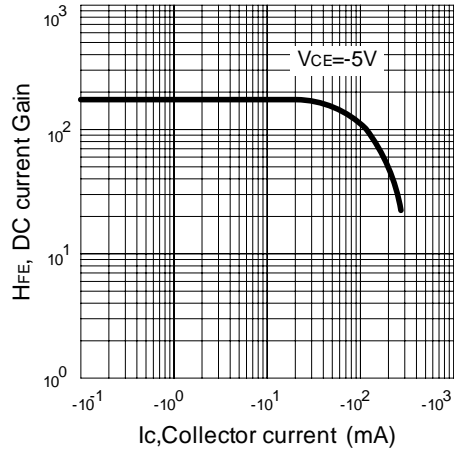

Fig.3 Base-Emitter on Voltage

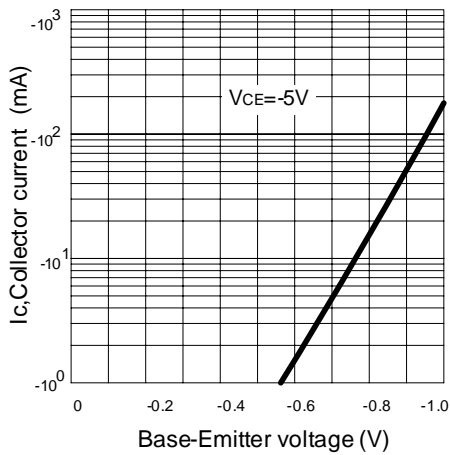

Fig.4 Saturation voltage

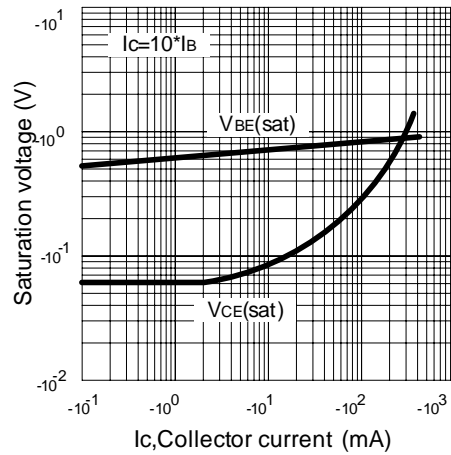
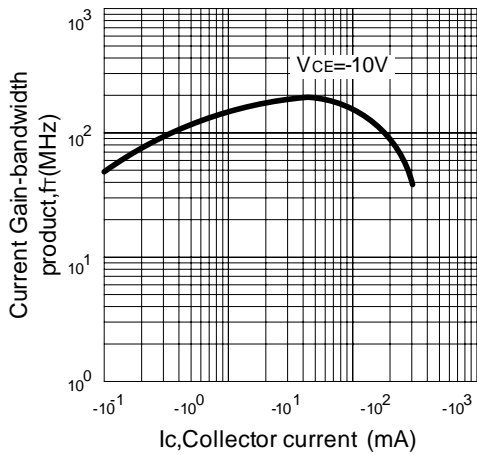

Fig.5 Current gain -bandwidth product



UTC assumes no responsibility for equipment failures that result from using products at values that exceed, even momentarily, rated values (such as maximum ratings, operating condition ranges, or other parameters) listed in products specifications of any and all UTC products described or contained herein. UTC products are not designed for use in life support appliances, devices or systems where malfunction of these products can be reasonably expected to result in personal injury. Reproduction in whole or in part is prohibited without the prior written consent of the copyright owner. The information presented in this document does not form part of any quotation or contract, is believed to be accurate and reliable and may be changed without notice.